

2641A

2645A

2645S

Display
Station

Reference Manual



HEWLETT-PACKARD COMPANY
19400 HOMESTEAD ROAD, CUPERTINO, CALIFORNIA, 95014

LIST OF EFFECTIVE PAGES

Changed pages are identified by a change number adjacent to the page number. Changed information is indicated by a vertical line in the outer margin of the page. Original pages do not include a change number and are indicated as change number 0 on this page. Insert latest changed pages and destroy superseded pages.

Change 0 (Original) Oct 1977

NOTICE

The information contained in this document is subject to change without notice.

HEWLETT-PACKARD MAKES NO WARRANTY OF ANY KIND WITH REGARD TO THIS MATERIAL, INCLUDING, BUT NOT LIMITED TO, THE IMPLIED WARRANTIES OF MERCHANTABILITY AND FITNESS FOR A PARTICULAR PURPOSE. Hewlett-Packard shall not be liable for errors contained herein or for incidental or consequential damages in connection with the furnishing, performance or use of this material.

Hewlett-Packard assumes no responsibility for the use or reliability of its software on equipment that is not furnished by Hewlett-Packard.

This document contains proprietary information which is protected by copyright. All rights are reserved. No part of this document may be photocopied, reproduced or translated to another program language without the prior written consent of Hewlett-Packard Company.

This manual contains detailed programming and accessory information for the HP 2641A, HP 2645A, and HP 2645S Display Terminals. It is written to provide a system programmer with the information needed to use the terminal in a variety of applications. Extensive information explaining the operation of the terminal's data communication function is provided in a separate section.

The HP 2641A terminal allows the user to access either the ASCII or APL character sets. A discussion of APL characters and APL terminal operation is given in the various sections where applicable.

The HP 2645S terminals use special Swedish/Finnish character sets for both the keyboard and display characters. The graphic symbols for some of the ASCII character codes have been changed to provide these special character graphics.

The programming functions selected by these ASCII codes remain the same. All references in this manual to ASCII characters used in escape or control sequences will use the standard ASCII character graphic. A table of the changed character graphics for the HP 2645S is given below.

OCTAL VALUE	DECIMAL VALUE	ASCII GRAPHIC	2645S GRAPHIC
133	91	[Ä
134	92	\	Ö
135	93]	Å
136	94	^	^
173	123	{	ä
174	124		ö
175	125	}	å
176	126	~	—

In addition, the placement of characters on the terminal keyboard has been altered on the HP 2641A and HP 2645S terminals to accommodate the new graphic characters. Additional information on the HP 2641A and HP 2645S is contained in the respective *User Manual*.

This manual assumes that you are already familiar with operating the terminal from the keyboard. Operating information is given in the following manuals:

- 2641A — *HP 2641A Display Station User's Manual* (02641-90001).
- 2645A — *HP 2645A Display Station User's Manual* (02645-90005).
- 2645S — *HP 2645S Display Station User's Manual* (02645-90024).

The HP 2641A, HP 2645A, HP 2645S Service Manual (02645-90003) provides a discussion of troubleshooting, repair, and theory of operation for all of the above terminals.

HOW TO USE THIS MANUAL

This manual describes all of the terminal's programmable features. The various functional groups such as display control and communications are described in separate sections. If you have not used an HP terminal before you should read Section I for a brief overview of the terminal and its capabilities. If you are familiar with the HP 2645 series terminals you can use the index at the back of the manual to locate answers to specific questions.

This manual is made up of the following sections and appendices (any differences between terminals are covered at the end of the section):

Section I. *General Description* — This section provides a brief description of the terminal, its operating modes, and overall capabilities.

Section II. *Display Memory Functions* — This section contains information for controlling the terminal display. Included are cursor sensing and positioning, fields, edit operations, and display enhancements.

Section III. *Terminal Control Functions* — This section contains information for programmatically controlling the terminal's various switch settings.

Section IV. *Device Control* — This section describes how to control optional input/output devices (cartridge tape drives, printers, etc.)

Section V. *Data Communications* — This section describes the terminal's communication function and gives procedures for configuring the terminal to meet various communication requirements.

Section VI. *Status* — This section describes how to obtain and interpret terminal status.

Section VII. *Installation* — This section contains step-by-step procedures for installing and configuring the terminal and its accessories.

Appendix A. *Applications* — This appendix contains examples of various terminal applications.




Appendix B. *Reference Tables* — This appendix contains condensed reference information for all of the terminal's features.

Appendix C. *Communications Flowcharts* — This appendix contains flowcharts of the communication function.

Appendix D. *Cartridge Tape Rethreading Procedure* — This appendix contains a procedure for rethreading cartridge tapes.

TERMS AND CONVENTIONS

The descriptions in this manual use the following text conventions:

`<character>c` or ` <character>` — When a character is shown followed by a superscript `c` or is shown preceded by the `` key, it indicates a control character. Control characters are normally generated from the keyboard by holding the `` key down while pressing the character.

Example: `Gc` = bell character

`[<>]` — The right and left bracket, less than, and greater than characters are used to set off variable parameters in some escape code sequences. These characters are added for descriptive purposes and are not a part of the escape sequence. They should not be transmitted.

Example: `Esc & p [<"from" device code>s]`

CONTENTS

Section I	Page
GENERAL DESCRIPTION	
Introduction	1-1
Mainframe	1-1
Terminal Bus	1-1
Terminal Memory	1-1
Input/Output Modules	1-4
CRT Monitor	1-4
The Raster	1-4
Alphanumeric and Microvector Character Sets	1-4
Display Features and Alternate Character Sets	1-4
Keyboard	1-5
The Firmware	1-5
System Monitor	1-5
Keyboard and I/O Subsystem	1-5
Cursor Movement	1-5
Display Memory Management	1-6
Data Communications	1-6
The Tape Units	1-7

Section II	Page
DISPLAY MEMORY FUNCTIONS	
Introduction	2-1
Display Control	2-1
Memory Addressing Scheme	2-2
Cursor Sensing	2-2
Cursor Positioning	2-2
Combinations of Absolute and Relative Addressing	2-3
Other Cursor Operations	2-2
Tabs	2-4
Margins	2-4
Edit Operations	2-5
Insert Character With Wraparound	2-5
Delete Character With Wraparound	2-5
Moving Text Blocks	2-6
Forms Mode (Format Mode)	2-7
Protected Fields	2-7
Unprotected Fields	2-7
Transmit Only Fields	2-7
Data Checking	2-7
Tabbing	2-8
Editing	2-8
Building the Form	2-8
Display Enhancements	2-8
Alternate Character Sets	2-9
Selecting Alternate Sets	2-9
Using Alternate Sets	2-9
HP 2641A Differences	2-14
Edit Operations	2-14
Inputting Data	2-15
Display Enhancements	2-15

Section III	Page
TERMINAL CONTROL FUNCTIONS	
Introduction	3-1
Latching Keys	3-1
Keyboard Interface Switches	3-1
Programmable Soft Keys	3-3
Controlling the Soft Key Display	3-3
Defining Soft Keys	3-3
Soft Key Applications	3-4
Using Soft Key Labels	3-4
Additional Control Functions	3-4
Bell	3-4
Send Display	3-5
Wait	3-5
Keyboard Disable/Enable	3-5
Reset Terminal	3-5
Monitor Mode	3-5
Self-Test	3-5
Modem Disconnect	3-5
Program Down Load	3-5

Section IV	Page
DEVICE CONTROL	
Introduction	4-1
Using the Generalized Escape Sequence	4-1
Selecting Input/Output Devices	4-2
Controlling the Devices	4-2
Cartridge Tapes	4-2
Display	4-3
Printer	4-3
Transferring Data From Device to Computer	4-3
ASCII Transfers	4-3
Binary Transfers	4-3
Transferring Data From Computer to Device	4-4
Copying a Record	4-4
Copying a File	4-4
Copying to End of Medium	4-5
Fast Binary Read (Program Loading)	4-5
Indicating Successful Completion of a Program-Controlled Function	4-5

Section V	Page
DATA COMMUNICATIONS	
Introduction	5-1
Connecting Terminal to a Computer	5-1
Networks	5-1
Interfaces	5-1
Interface Signals	5-1
Modems	5-1
Communication Protocols	5-6
Character Protocols	5-6
Block Protocols	5-7

CONTENTS (continued)

<p>Character Protocols 5-7</p> <p style="padding-left: 20px;">Operating at High Speeds 5-7</p> <p style="padding-left: 20px;">Character Mode 5-8</p> <p style="padding-left: 20px;">Multicharacter Transfers 5-8</p> <p style="padding-left: 20px;">Block Mode 5-9</p> <p style="padding-left: 20px;">Full Duplex Operation 5-9</p> <p style="padding-left: 20px;">Teletype Compatible Communications 5-9</p> <p style="padding-left: 20px;">Half Duplex Operation(202 Modem Compatibility) 5-9</p> <p style="padding-left: 20px;">Monitor Mode 5-15</p> <p style="padding-left: 20px;">Configuration 5-15</p> <p>Block Protocols with 13260C or 13260D Communications Accessory 5-24</p> <p style="padding-left: 20px;">Character Mode Transfers 5-24</p> <p style="padding-left: 20px;">Multi Character Transfers 5-24</p> <p style="padding-left: 20px;">Message Blocks 5-24</p> <p style="padding-left: 20px;">Block Operation 5-24</p> <p style="padding-left: 20px;">Block Protocol Control Sequences 5-27</p> <p style="padding-left: 20px;">Multipoint Communications 5-33</p> <p style="padding-left: 20px;">Control Sequences 5-35</p> <p style="padding-left: 20px;">Configuration Procedure 5-38</p> <p style="padding-left: 20px;">Monitor Mode 5-43</p> <p style="padding-left: 20px;">Driver Mode 5-45</p> <p>Section VI Page</p> <p>STATUS</p> <p>Introduction 6-1</p> <p>Interpreting Status 6-1</p> <p>Terminal Status 6-1</p> <p style="padding-left: 20px;">Primary Terminal Status 6-2</p> <p style="padding-left: 20px;">Secondary Terminal Status 6-4</p> <p>Device Status 6-6</p> <p>Section VII Page</p> <p>INSTALLATION</p> <p>Introduction 7-1</p> <p>Opening the Terminal 7-2</p> <p>Grounding Requirements 7-5</p> <p>Selecting Line Voltage 7-5</p> <p>Accessory Installation Procedures 7-6</p> <p style="padding-left: 20px;">64 Character Lower Case Rom 7-6</p> <p style="padding-left: 20px;">HP 13231A Display Enhancements 7-7</p> <p style="padding-left: 20px;">HP 13232 Cable Assemblies 7-8</p>	<p>HP 13234A (4K) Terminal Memory Module 7-10</p> <p>HP 13236B Cartridge Tape Unit 7-10</p> <p>HP 13238A Terminal Duplex Register 7-11</p> <p>HP 13245A Character Set Generation Kit 7-13</p> <p>HP 13246A/B Printer Subsystem (9866) 7-13</p> <p>HP 13250A Serial Printer Interface 7-13</p> <p>HP 13260A,B,C,D Data Communications Accessories 7-13</p> <p>HP 13261A Device Support Firmware 7-15</p> <p>HP 13349A Printer Subsystem (9871) 7-17</p> <p style="padding-left: 20px;">Power Supply Adjustment 7-17</p> <p>Selecting Optional Operating Functions 7-17</p> <p>Data Communications Cabling 7-26</p> <p style="padding-left: 20px;">Interface Signals 7-26</p> <p style="padding-left: 20px;">Logic Levels 7-26</p> <p style="padding-left: 20px;">Cable Types 7-26</p> <p style="padding-left: 20px;">Point-to-Point Communications Cabling 7-29</p> <p style="padding-left: 20px;">Multipoint Communications Cabling 7-29</p> <p style="padding-left: 20px;">Power Down Protect Cabling 7-29</p> <p style="padding-left: 20px;">Fabricating Your Own Data Communica- tions Cable 7-34</p> <p>Self-Test 7-39</p> <p style="padding-left: 20px;">Basic Self-Test 7-39</p> <p style="padding-left: 20px;">Cartridge Tape Unit Self-Test 7-43</p> <p style="padding-left: 20px;">Data Communications Self-Test 7-43</p> <p style="padding-left: 20px;">HP 2641A Display Station Differences 7-49</p> <p style="padding-left: 20px;">HP 2645S Display Station Differences 7-51</p> <p>Appendix A Page</p> <p>APPLICATIONS A-1</p> <p>Appendix B Page</p> <p>REFERENCE TABLES B-1</p> <p>Appendix C Page</p> <p>COMMUNICATIONS FLOWCHARTS C-1</p> <p>Appendix D Page</p> <p>CARTRIDGE TAPE RETHREADING PROCEDURE D-1</p>
--	---

ILLUSTRATIONS

Title	Page
2641A Terminal Architecture	1-2
2645A/S Terminal Architecture	1-3
System Monitor Basic Loop	1-5
Display Memory Linked List Structure	1-6
Row Addressing	2-1
Column Addressing	2-2
Character Delete With Margins	2-6
Character Delete With Wraparound	2-6
Character Set Locations	2-9
Example Using the Math Set	2-10
Example Using the Large Character Set	2-10
Math Set Elements	2-11
Large Character Set Elements	2-12
Line Drawing Set	2-13
Sample Form	2-14
Terminal Network Configurations	5-2
Block Transfer Enabled by the ENTER Key	5-8
Block Transfer Enabled by the Computer	5-9
Block Mode Operation	5-10
Example of Format Mode with Page Strapping	5-11
Main Channel Protocol	5-16
Sample Data Transfers Using Main Channel Protocol	5-17
Reverse Channel Protocol	5-18
Sample Data Transfers Using Reverse Channel Protocol	5-19
Point-to-Point Data Communications Configuration Flowchart	5-20
Examples of Block Transmissions	5-24
Operation of Block Protocol Control Characters	5-29
Block Keyboard Data Communication Switches	5-32
Terminal Addressing	5-35
Typical Configuration Status Request and Response Sequence	5-37
Configuration Status Byte Contents	5-38
Multipoint Data Communications Configuration Flowchart	5-39
Communication Line Using a Monitor	5-43
Sample Data Transfers Displayed in Monitor Mode	5-44
Character Distortion in Group Poll	5-44
Data Overflow Indication	5-44
Driver Mode Configuration	5-45
Sample Select Sequence Using Driver Mode	5-46
Control Character Display On Driver Terminal	5-46
Terminal Input	5-46
Primary Terminal Status Example	6-2
Secondary Terminal Status Example	6-4
Device Status Example	6-6
Opening the Terminal	7-2
Mainframe Bottom Part Locations	7-3
Mainframe Top Part Locations	7-4
Fuse Positions for 115 VAC and 230 VAC Line Voltage	7-5
Display Control PCA Component Locations	7-6
Display Expansion PCA Jumper and ROM Socket Locations	7-8
Top Plane Assembly Removal	7-8
Control Memory PCA Jumper Socket Location	7-11
4K Memory PCA Jumper Socket Location	7-11
Typical Memory Map	7-12
Configuring 4K Memory PCA Jumpers	7-12
Terminal Duplex Register PCA Jumper Configuration	7-12
Control Memory PCA Data Comm Firmware IC Locations	7-15
Installing Keyboard Overlays	7-16
13231A Device Support Firmware IC Locations on Control Memory PCA	7-16
Typical Strapping Option Switch Assembly	7-18
Keyboard Interface PCA Strapping Options	7-18
Extended Asynchronous Communications PCA Strapping Options	7-22
Asynchronous Multipoint Communications PCA Strapping Options	7-26
Synchronous Multipoint Communications PCA Strapping Options	7-26
Point-to-Point Communications Cabling	7-29
Current Loop Cabling	7-29
Modem By-Pass Cabling	7-29
Asynchronous Multipoint Cabling	7-30
Synchronous Multipoint Cabling	7-31
Power-Down-Protect Cabling for Asynchronous Multipoint Configuration	7-32
Power-Down-Protect Cabling for Synchronous Multipoint Configuration	7-33
Assembling the PCA Hood Connector	7-36
Assembling the RS232C Connector	7-37
Assembling the Multipoint Connector	7-38
Basic Self-Test Patterns (HP 2645A)	7-39
Basic Terminal Self-Test Flowchart	7-40
Basic Data Comm Self-Test Flowchart	7-46
Multipoint Data Comm Self-Test Flowchart	7-48
Display Enhancement PCA Jumper and ROM Socket Locations (HP 2641A)	7-49
Second Control Memory PCA Jumper Con- figurations (HP 2641A)	7-49
13261A Device Support Firmware IC Locations on Control Memory PCA (HP 2641A)	7-50
Basic Self-Test Patterns (HP 2641A)	7-50
Basic Self-Test Patterns (HP 2645S)	7-51
Point-to-Point Communications Flowcharts	C-5
Keyboard Communication Switches Flowcharts	C-9
Tape Cartridge Rethreading	D-1

TABLES

Title	Page
Cursor/Display Operations	2-3
Edit Operations	2-5
Keyboard Interface Switch Summary	3-2
Device Control Escape Sequences	4-1
Data Communication Interfaces	5-1
Data Communication Interface Capabilities	5-3
Keyboard Communications Switches	5-4
Keyboard Interface Switch Summary	5-5
Modems	5-6
Protocol Characteristics	5-7
Terminal Functions	5-7
Keyboard Interface PCA Strapping Options for Point-to-Point	5-12
Parities Available with ASCII Data	5-25
Block Protocol Control Characters	5-27
Summary of Block Protocol Control Characters	5-29
Keyboard Interface Straps for Block Operation Using 13260C or 13260D Communications Accessory	5-31
Terminal Address Characters	5-34
Display Expansion PCA Jumper Protocol	7-8
HP 13232 Cable Assemblies	7-9
Contents of HP 13260 Data Communications Accessories	7-14
Keyboard Interface PCA Strapping Options for Point-to-Point	7-19
Keyboard Interface PCA Strapping Options for Multipoint	7-21
Extended Asynchronous Communications Interface Strapping Options	7-23
Asynchronous Multipoint Communications Interface Strapping Options	7-24
Synchronous Multipoint Communications Interface Strapping Options	7-25
EIA RS232C and CCITTV24 Interface Data and Control Signals	7-27
Data Communications Signal Levels	7-27
Multipoint Data Communication Cables	7-28
Parts for Fabricating Your Custom Data Communications Cable	7-34
13260 Series Data Communications PCA Signal Names	7-35
Data Communications Self-Test Connectors	7-44
Point-to-Point Data Communications Self-Test Procedure	7-44
Multipoint Data Communications Self-Test Procedure	7-47
Programmer's Reference Table (HP 2641A)	B-2
Character Code Chart (HP 2641A)	B-4
APL Symbols	B-5
APL-ASCII Bit-Pairing Transmission Codes	B-6
APL-ASCII Typewriter-Pairing Trans- mission Codes	B-6
Options and Accessories (HP 2641A)	B-7
2641A Specifications	B-8
Programmer's Reference Table (HP 2645A)	B-9
Character Code Chart (HP 2645A)	B-11
Options and Accessories (HP 2645A)	B-12
2645A Specifications	B-13
Programmer's Reference Table (HP 2645S)	B-14
Character Code Chart (HP 2645S)	B-16
Options and Accessories (HP 2645S)	B-17
2645S Specifications	B-18
Coding the Large Character Set	B-19
ASCII Character Set	C-1
ASCII to EBCDIC Code Conversion Table	C-1

INTRODUCTION

The Display Station (hereinafter referred to as a terminal) uses a microprocessor under firmware control. It operates in character or block mode, with full editing capability. The terminal is designed for such applications as data entry and preparation, information display and editing, interactive programming, data communications, and time-sharing operations.

In addition to the features of the basic terminal, option 007 provides an integrated mass storage capability of up to 220 kilobytes of data using two tape cartridges. This terminal is designed particularly for stand-alone or on-line operation. For example, forms designed at the terminal using the line drawing and/or other character sets can be stored on a tape cartridge and selectively retrieved from the keyboard or through commands from a remote computer.

Data communications accessories are also available to provide a choice of communications capability. The standard terminal is teletypewriter compatible (EIA RS232-C serial asynchronous, ASCII, half or full duplex). It operates at speeds up to 9600 bits per second, and transmits either character-by-character as a fully interactive terminal or operates on variable length blocks of information. Optional capabilities include 20mA current loop; and either asynchronous or synchronous polling for multipoint communications networks. Also, the terminal can be used with a wide selection of modems over dialed or leased lines.

A block diagram of the terminal is shown in figure 1-1. The terminal has three major and mechanically independent sections: keyboard, CRT monitor, and mainframe. The specific functional properties of the terminal are determined by firmware programs resident in ROM (read-only-memory). It is these programs, occupying up to 24K bytes of ROM (26K in the 2641A), that make it possible for the terminal to have many powerful features such as self test, dynamic memory allocation, transparent control codes, and off-screen storage.

MAINFRAME

The heart of the system is the mainframe section, which can be considered a microcomputer system. In the mainframe is the power supply and a bus-oriented logic system containing the microprocessor, program and data memory, video display subsystem, keyboard interface, and data communications interface. The basic terminal contains seven slots for options and accessories. All mainframe modules are functionally, mechanically, and electrically

independent, giving a high degree of flexibility and reducing service time.

TERMINAL BUS

A major element of the logic system is the terminal bus (a printed circuit board with connectors) which is attached to the bottom of the mainframe and to the power supply. The bus distributes power to the individual modules and provides data, address, and control lines for communication between the various logic functions. The terminal bus provides communication paths between processor, memory, input/output, and display refresh on a shared basis.

All modules are slot-independent and carry their own select code or memory address. There are only two rules: group the three display modules together, and leave no empty slots between the power supply and the last module. However, the two cartridge tape modules (part of option 007) can be plugged into the connectors on the far end, opposite the power supply.

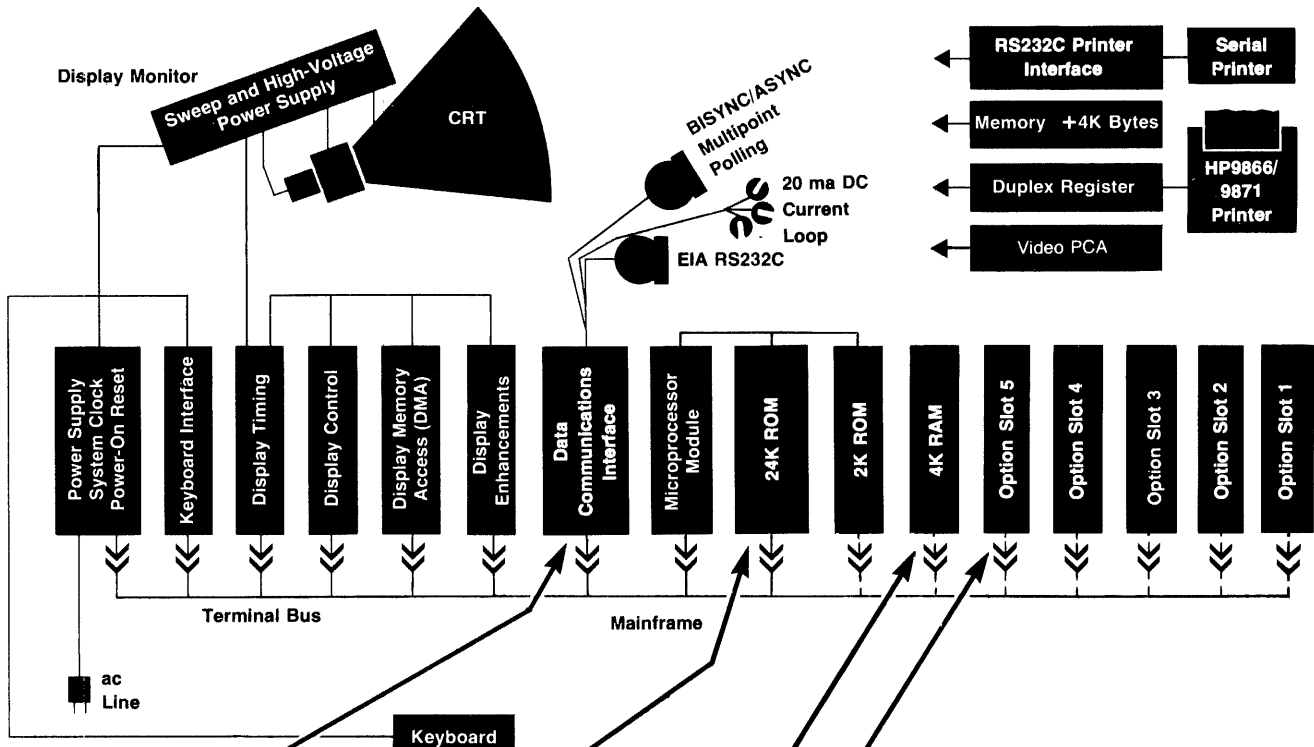
A bus access cycle begins when a requesting module determines it needs the terminal bus for instruction or data fetch or input/output. If the terminal bus is busy, the requesting module must wait until it is available. To determine who gets the bus next, a priority chain has been incorporated. The modules nearest the power supply are first in the priority chain, and a module wanting the bus next breaks the chain for modules farther away from the power supply.

TERMINAL MEMORY

Like any other computer system, the microcomputer module is useful only if it has a program to execute and memory in which to store data. This is the function of the terminal memory modules, which are two types, read/write or random-access memory (RAM) and read-only memory (ROM). The RAM stores display characters and data; the ROM stores terminal programs (firmware). Terminal programs are called firmware because the ROM makes them more permanent than software but less permanent than hardware. In the terminal three-quarters of the available memory is dedicated to ROM or program memory and the balance of the available memory locations (16K bytes) can be used for RAM. All of the terminal memory is MOS semiconductor memory.

Optional +4K RAM modules are added when more random-access memory is required for display and data storage.

2641A Block Diagram



- Choice of Data Communications Capability:
 - Standard Asynchronous
 - Extended Asynchronous (Current Loop)
 - Async. Multipoint
 - Sync. Multipoint (Bisync)
- Microprocessor now controls terminal with 26K ROM providing additional user-oriented features
- Display memory now 4K bytes standard, expandable to 12K bytes maximum.
- Optional cartridge tape drives (also field installable)
 - Tape electronics requires two option slots—

Figure 1-1. 2641A Architecture

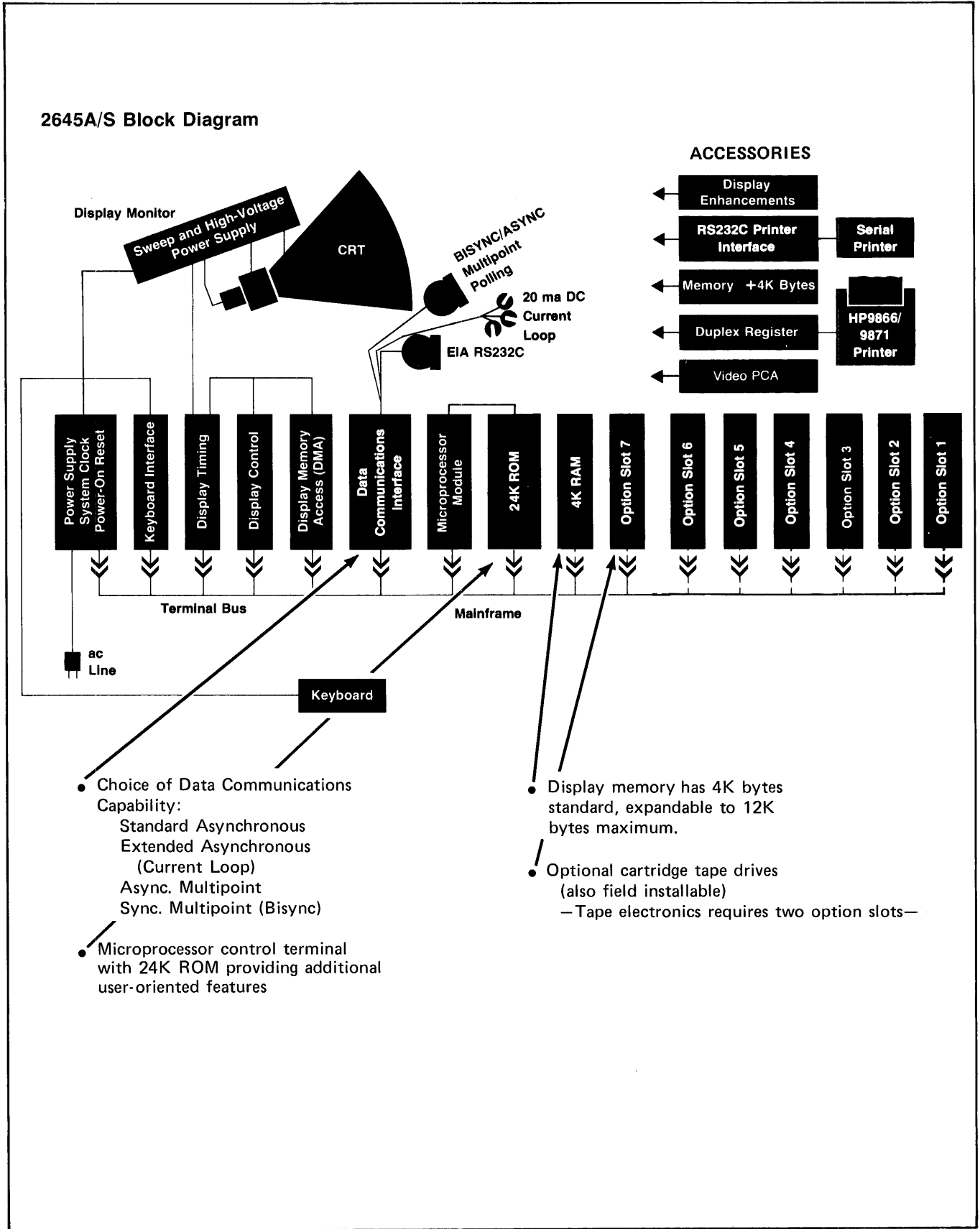


Figure 1-2. 2645A/S Architecture

General Description

INPUT/OUTPUT MODULES

Also a part of the logic system are several terminal input/output modules: the keyboard interface PCA, the data communications PCA, the eight-bit duplex register PCA (used for the HP 9866A and HP 9871A Printer interface), and the serial printer interface PCA. These never request control of the bus, but all must respond to commands from the microcomputer and its programs.

The basic I/O commands output data or control from the microprocessor and input data or status from the interface module. Each of the I/O cards has different data and control formats, but all are controlled by the microcomputer. Each I/O module has a rear edge connector for the attachment of a connector hood and cable assembly to carry the signals out the back of the terminal.

The display subsystem has two functions that use the bus. Cursor control is an output function and the DMA refresh is a bus requestor for memory read operations.

CRT MONITOR

The CRT monitor section contains sweep and high voltage circuits, the high-resolution, low-profile cathode-ray tube, and fan.

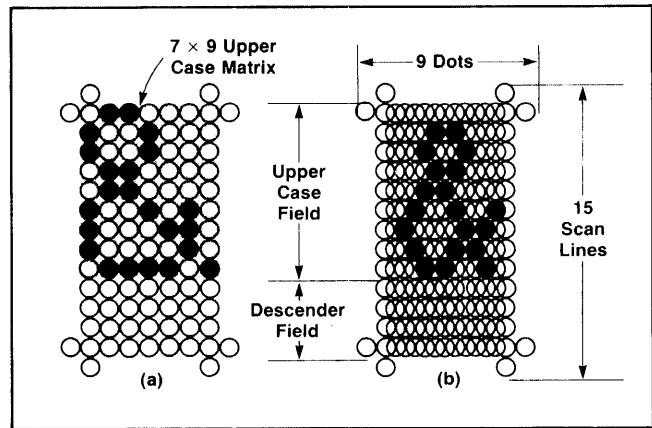
THE RASTER

The terminal uses raster scan deflection method, similar to that used in television sets. In a raster scan display, the electron beam traverses the screen in a series of closely spaced horizontal lines, starting from the top. Characters are formed from line segments and dots produced by turning the beam intensity on and off at appropriate times.

The terminal uses a low-profile CRT to keep overall height to a minimum while maintaining a screen capacity of 1920 characters, partitioned into 24 rows of 80 characters each. All of the character positions are fundamentally rectangles 7 dots wide by 9 scan lines high. Four additional scan lines beneath the 7×9 matrix are used for the descender areas of lower-case characters, for underlining, and for the blinking underscore cursor. One other dot is used on either side for character-to-character spacing, and one scan line is reserved at the top and bottom for row-to-row spacing. This results in a character cell of 9 dots by 15 scan lines replicated over the entire screen area (see figure 1-2).

ALPHANUMERIC AND MICROVECTOR CHARACTER SETS

Two types of character sets can be stored within the terminal: alphanumeric sets and microvector sets. Alphanumeric sets support the primary use of the terminal, displaying textual and numeric information. Characters are designed around a basic 7×9 dot matrix with provision for lower-case descenders. The characters are embellished



by use of the half-shift. With this type of set the character-to-character spacing of two dots is hardwired. This prevents the design of characters that would form continuous horizontal lines. However, all 15 scan lines of the row are available so that vertically contiguous symbol segments can be designed. An example of this is the three-row-high integral sign found in the math symbol set.

Microvector sets use the entire 9-dot-by-15-scan-line character cell without the half-shift. This allows characters to be designed with both horizontal and vertical continuity. This type of set finds its greatest application where a minimal set of graphic kernels is needed to represent more complex pictorial information. The figure on page 3-6 illustrates the use of the line drawing set in representing a form.

DISPLAY FEATURES AND ALTERNATE CHARACTER SETS

The basic 2641A terminal has a repertoire of 64 alphanumeric characters (128 optional), 128 APL characters, 64 overstrike characters, inverse video fields (black characters on white background), half-bright, underline, and blinking fields. One additional 128-character set can be stored in the terminal.

The basic 2645A/S Terminal has a repertoire of 64 alphanumeric characters (128 optional) and one display feature, inverse video fields (black characters on white backgrounds). With the addition of the display enhancement board, up to three additional 128-character sets can be stored within the terminal. Three display features are also added: half-bright, underline, and blinking fields.

All sixteen possible combinations of the four display features can be applied to any character or characters on the screen. No displayable character positions are required to start, stop, or modify either the features or the character sets. Therefore, consecutive characters on the screen may be from different sets or have different display features.

KEYBOARD

The processor scans the keyboard at discrete intervals for a depressed key. Each key is assigned a position in a matrix of 16 columns and 8 rows. This matrix provides a reference to a look-up table that the firmware uses to display the character and/or send the character code over the data communications line.

THE FIRMWARE

SYSTEM MONITOR

The system monitor is a section of the firmware that dispatches data within the terminal. The processor normally executes a basic loop, in which it scans the keyboard and the data communications interface and waits for something to happen (see figure 1-3). When a character is received from either the keyboard or the data communications interface, a general character interpretation routine is executed to determine the action to be taken. The monitor then performs the specified functions, such as putting a character on the display, transmitting a character over the data communications interface, or moving the cursor. When this has been completed, the monitor returns to the basic scan loop to look for the next input.

The firmware operates under both scan and interrupt methods. The keyboard is scanned at regular intervals, and inputs from the devices such as the data communications interface and cartridge tape units are interrupt driven.

KEYBOARD AND I/O SUBSYSTEM

The I/O subsystem contains the firmware required for performing all input/output functions. The firmware operates under both scan and interrupt methods. The keyboard is scanned at regular intervals, and inputs from the devices such as the data communications interface and cartridge tape units are interrupt driven. If a new key depression is detected, the key number associated with this key is calculated and used as an index into a table that assigns a code to the key. If the key is one of the ASCII keys, the proper code is determined based on the state of the CNTRL, SHIFT, and CAPS LOCK keys.

If the key in question is not one of the ASCII keys, the firmware may be required to generate a multiple character sequence consisting of an ASCII escape character followed by one or more characters that define the escape sequence. Keys in a third group do not generate codes at all, but simply perform internal terminal functions, such as BLOCK MODE, REMOTE, and CAPS LOCK.

I/O associated with the display is minimal because the display memory access module (DMA) causes the display to be refreshed without processor intervention. Display I/O control mainly involves transmitting the cursor coordinates to the display whenever necessary.

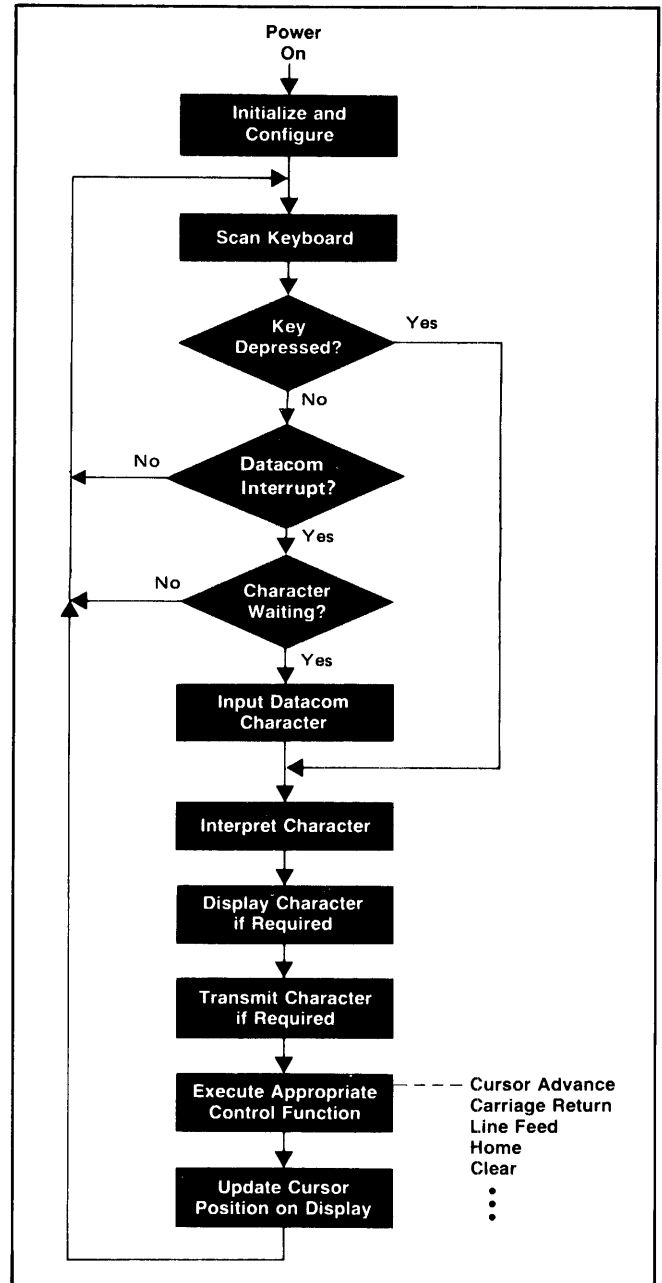


Figure 1-3. System Monitor Basic Loop

CURSOR MOVEMENT

The terminal firmware contains many subroutines for moving the cursor on the display. All cursor movement is handled by the firmware. When a character is typed on the keyboard and appears on the display, the cursor moves to the next column position because a cursor advance subroutine has been executed and has calculated a new cursor position. Similar subroutines exist for moving the cursor up, down, right, left, and home. The tab function is also a firmware routine; it uses a one-bit-per-column table to determine the next tab stop.

DISPLAY MEMORY MANAGEMENT

A large part of the terminal firmware is devoted to management of the display memory. Most conventional terminals use a byte of display memory for every displayable position on the CRT screen. If there are many short lines, as is frequently the case, there is a substantial amount of unused memory. The terminal does not allocate memory for character positions to the right of the last character entered, so this memory is available for other purposes. Turn on and turn off of the various display enhancements and character set selections, or start and end of unprotected fields between individual characters can be accomplished without an intermediate blank character position. With these features, the address of a character occupying a given row and column cannot be directly computed without some sort of scanning process.

The display memory consists basically of a linked list of fixed-sized blocks of RAM (see figure 1-4). This list is set up in such a way that the DMA can start at the first address on the screen and follow the list to produce an entire screen of information. All memory not currently allocated for display use is kept on a free-storage link list. Individual rows are linked with next and preceding rows, while blocks within a row are linked only in a forward direction. The storage allocated for a row may be as little as one block (16 bytes), or much larger than 80 characters, depending upon the number of displayable and non-displayable characters needed to create the row on the CRT.

The firmware finds the address corresponding to a given character position by starting at the last known position and moving through the list either backward or forward until it finds the new address. If the end of the list is found before the row in question has been found, blocks are removed from the free-storage list and used to create new rows. Once the correct row has been found, the firmware searches for the cursor column. If the end of the row is found before the column has been found, additional blocks are removed from the free-storage list and used to build the length of the row out to the column required. Whenever a block is required and free list is empty, an existing row must be released from display memory. This row is the first row of memory if the addition is at the end of memory, and is the last row of memory if a row other than the last row is being lengthened.

DATA COMMUNICATIONS

Data communications in the terminal is both a hardware and a firmware function. The data communications interface is a basic terminal module. This module has the necessary logic to interface the terminal bus to the communication line.

The communication interface accepts parallel data from the terminal, serializes it, and adds framing or synchronizing bits (start and stop). It performs the reverse process on incoming data, converting serial data to par-

allel and removing start and stop bits. The interface can generate and check parity and can also detect data overruns. A status word keeps the processor informed of the status of the interface.

The terminal firmware for communications has three main functions. First, the program reads the control settings on the keyboard, keyboard interface, and the data communications interface. Second, it processes input characters and transmits output characters. Many decisions are made on incoming characters, especially on control characters. The third function is modem control using control lines on the communications interface. Direct connections to a computer and Bell 103 type modems require a minimum of firmware control while Bell 202 type modems require more control. A more detailed description of the data communications operation is given in Section V.

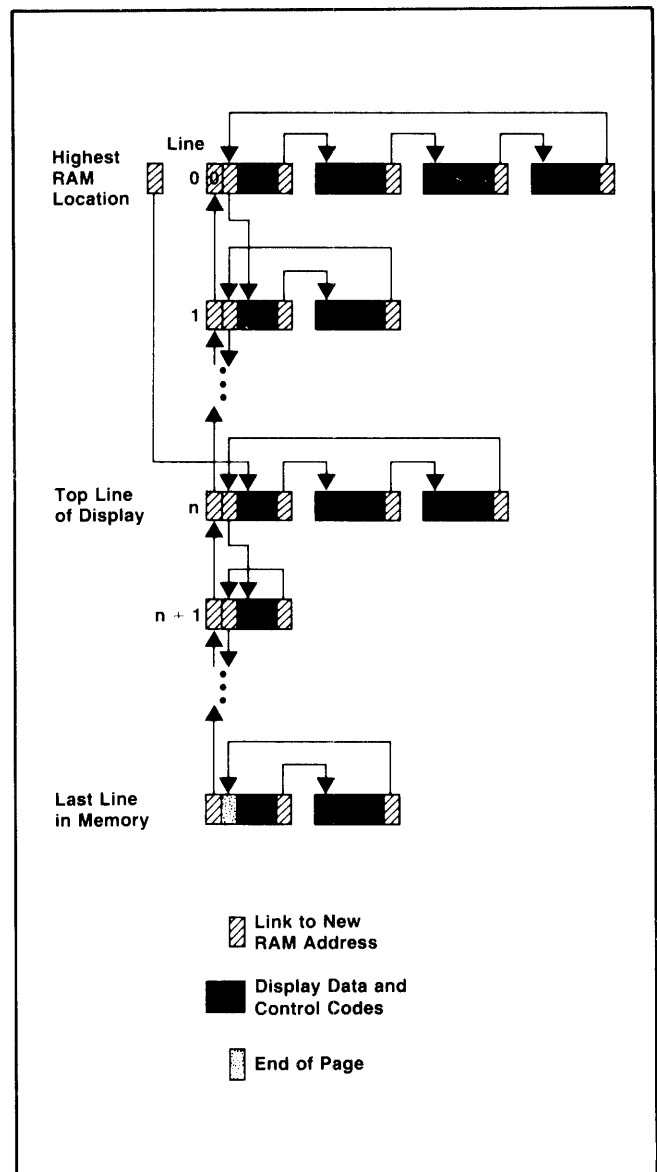


Figure 1-4. Display Memory Linked List Structure

THE TAPE UNITS

Cartridge tape operations is divided between the cartridge tape hardware and firmware. The hardware maintains constant speed and provides for selection of fast or slow speed and the direction of tape motion.

A line of data on the screen is recorded on the tape as a record. The information is stored serially on the tape at a recording density of 800 bits per inch and a read/write speed of 10 inches per second. Data is organized into files, records, bytes, and bits. Separating the files are file marks, special-length gaps (areas of unidirectional magnetization) with a file identification record between them.

Holes are punched at each end of the tape to provide reference for beginning of tape and end of tape. If a hole is detected in the tape, indicating tape location, tape motion is stopped until the firmware commands it to start again.

The hardware encodes and decodes data bytes into bit patterns on the tape and records interrecord gaps. The hardware reacts to commands given by the firmware and presents status information to the firmware.

The firmware controls all tape motion and maintains tape-position information. The firmware dictates whether the hardware is reading, recording, or writing gaps. It formats data into records and generates special tape marks that have significance in organizing the tape into records and files.

DISPLAY MEMORY FUNCTIONS

INTRODUCTION

This section contains information for controlling the terminal's display memory functions. The display memory functions change the position of display data or assign special attributes to blocks or fields of display data. The special attributes alter the way data is displayed or transmitted. These functions consist of the following groups:

- Display Control
- Edit Operations
- Forms Mode
- Display Enhancements
- Alternate Character Sets

The following paragraphs describe how to control the display memory functions from a computer program. Each of the display functions can also be entered from the terminal keyboard or read from a cartridge tape. In addition to escape sequences, most of the display memory functions have been assigned to special keys on the keyboard. Refer to the User's Manual for a description of keyboard functions.

DISPLAY CONTROL

The display control functions are made up of cursor and display positioning operations. The individual functions available are as follows:

- Cursor Sensing
 - Absolute
 - Relative
- Cursor Positioning
 - Absolute Addressing
 - ScreenRelative Addressing

- Cursor Relative Addressing
 - Space
 - Backspace
 - Set Tab
 - Clear Tab
 - Tab
 - Backtab
 - Set Margins
 - Home Up
 - Home Down

- Display Positioning
 - Roll Up
 - Roll Down
 - Next Page
 - Previous Page
 - Display Lock (Memory Lock)

MEMORY ADDRESSING SCHEME

Display memory positions can be addressed using absolute or relative coordinate values. Display memory is made up of 80 columns (0-79) and a number of rows determined by the memory options installed in the terminal. There can be as many as 150 lines of 80 characters (6 screens). The amount of memory in the terminal can be determined from byte 0 of the primary terminal status (refer to Section VI). The types of addressing available are:

- Absolute
- Screen Relative
- Cursor Relative

ROW ADDRESSING. Figure 2-1 illustrates the way the three types of addressing affect row or line numbers. The cursor is shown positioned in the fourth row on the screen. Screen row 0 is currently at row 6 of display memory. In

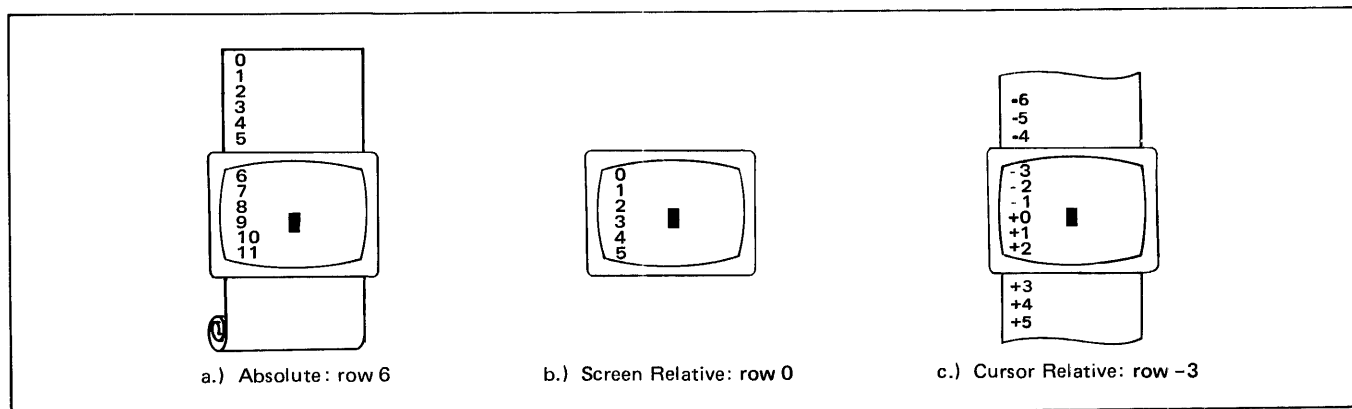


Figure 2-1. Row Addressing

order to reposition the cursor to the first line of the screen the following three destination rows could be used:

- a. Absolute: row 6
- b. Screen Relative: row 0
- c. Cursor Relative: row -3

COLUMN ADDRESSING. Column addressing is accomplished in a manner similar to row addressing. There is no difference between screen and cursor relative column addressing. Figure 2-2 illustrates the difference between absolute and relative addressing. The cursor is shown in column 5.

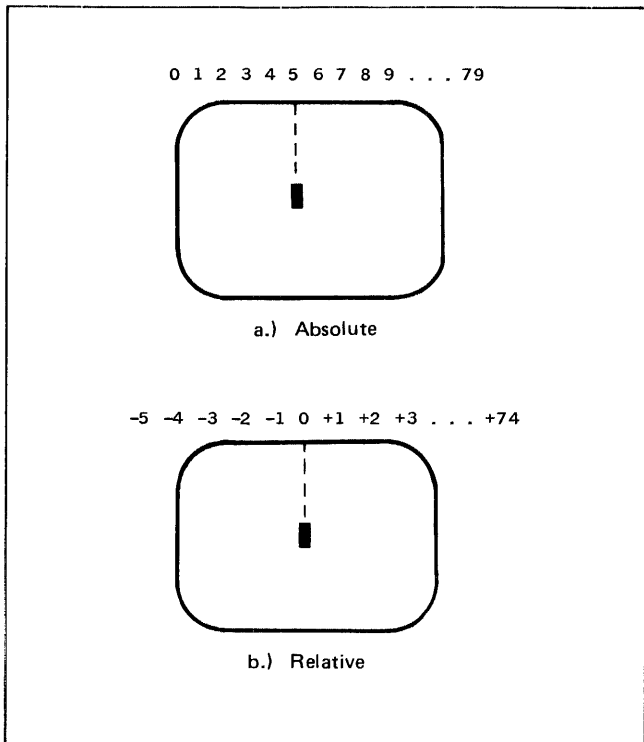


Figure 2-2. Column Addressing

Whenever the row or column addresses exceed those available, the largest possible value is substituted. In screen relative addressing, the cursor cannot be moved to a row position that is not currently displayed. For example, in figure 2-1c a relative row address of -10 would cause the cursor to be positioned at the top of the current screen (relative row -3). Column positions are limited to the available screen positions (0 to 79 in figure 2-2a and -5 to 74 in figure 2-2b). The cursor cannot be wrapped around from column 0 to column 79 by specifying large negative values for relative column positions.

CURSOR SENSING

The current position of the screen cursor can be sensed. The position returned can be the absolute position in display memory or the location relative to the current screen position. (Absolute and relative addresses are discussed under Cursor Addressing.)

Absolute Sensing ESC a

Example: The cursor is at column 20, row 40.

computer: ESC a

terminal: ESC & a 020c 040R

Relative Sensing ESC `

Example: The cursor is again at column 20, row 40, but screen row 0 begins at row 35 of display memory.

computer: ESC `

terminal: ESC & a 020c 005Y

CURSOR POSITIONING

The cursor can be positioned directly by giving memory or screen coordinates, or by sending the escape codes for any of the keyboard cursor positioning operations.

ABSOLUTE ADDRESSING. The cursor can be positioned to any displayable position using absolute coordinates. Absolute cursor positioning is accomplished using the following sequence:

ESC & a <row number> r <column number> C

where: row number is 0 to 255.

Example: Position the cursor at row 35, column 6.

ESC & a 35r 6C

or

ESC & a 6c 35R

SCREEN RELATIVE ADDRESSING. The cursor can be positioned to any position currently displayed on the screen by using screen relative coordinates:

ESC & a <screen row number> y
<column number> C

where: the top row of the screen is row 0.

Example: Position the cursor to screen relative row 15, column 53.

ESC & a 15y 53C

or

ESC & a 53c 15Y

CURSOR RELATIVE ADDRESSING. The cursor can be positioned to any displayable position by using cursor relative coordinates. (\pm row, \pm column).

Example: The cursor is currently at row 7 and column 10 of the screen. Move the cursor to row 9 column 6.

ESC & a +2r -4C
 or
 ESC & a -4c +2R

COMBINATIONS OF ABSOLUTE AND RELATIVE ADDRESSING.

Example. Move cursor from its current row down 8 rows and to column 60.

ESC & a +8r 60C
 or
 ESC & a 60c +8R

Example. Move cursor from its current position 15 columns left, and to relative screen row 4.

ESC & a 4y -15C
 or
 ESC & a -15c 4Y

OTHER CURSOR OPERATIONS

In addition to positioning the cursor using coordinates, you can use a variety of keyboard equivalent operations. These operations normally require only one or two characters to be sent to the terminal. Table 2-1 lists each of the operations together with its code and a brief description.


Table 2-1. Cursor/Display Operations

FUNCTION	CODE	DESCRIPTION
Cursor		
Line Feed	LF (J ^c)	Move the cursor to the next line.
Return	CR (M ^c)	Return the cursor to the left margin, halt I/O operations, and clears messages.
	ESC G	Move cursor to first column of current row.
Backspace	BS (H ^c)	Move the cursor one column to the left. If the cursor is in column 0, it remains there.
↑	ESC A	Move the cursor up one row. If the cursor is in row 0, it wraps around to row 23.
↓	ESC B	Move the cursor down one row. If the cursor is in row 23, it wraps around to row 0.
→	ESC C	Move the cursor right one column. If the cursor is in column 79, it wraps around to column 0 of the next row. If the cursor is in row 23, column 79, it wraps around to row 0, column 0.
←	ESC D	Move the cursor left one column. If the cursor is in column 0, it wraps around to column 79 of the previous row. If the cursor is in row 0, column 0, it wraps around to row 23, column 79.
↖	ESC h	Move the cursor to the beginning of the first line of memory (excluding transmit-only fields in Format Mode.)
Home Up Cursor	ESC H	Move cursor to the beginning of the first line in display memory (including transmit only fields in Format Mode).
Home Down Cursor	ESC F	Move the cursor to the beginning of the line following the last data in display memory.
Tabs		
Tab	HT (I ^c) or ESC I	Move the cursor forward to the next tab position.
Back Tab	ESC i	Move the cursor back to the previous tab position.
Set Tab	ESC 1	Place a tab at the current cursor column.
Clear Tab	ESC 2	Clear the tab at the current cursor column.
Clear All Tabs	ESC 3	Clear all tabs in display memory.

Table 2-1. Cursor/Display Operations (Continued)

FUNCTION	CODE	DESCRIPTION
Margins		
Set Left Margin	ESC 4	Set the left margin at the current cursor column.
Set Right Margin	ESC 5	Set the right margin at the current cursor column.
Display		
Clear Display	ESC J	Clear display memory from the cursor position to the end of memory.
Clear Remaining Line	ESC K	Clear current line beginning at the column containing the cursor.
Roll Up	ESC S	Roll the screen up one row (until the last row of memory is located at the top of the display). Cursor is stationary.
Roll Down	ESC T	Roll the screen down one row (until the first row of memory is located at the top of the display). Cursor is stationary.
Next Page	ESC U	Display the next 24 rows of memory (until the last row of memory is located at the top of the display). The cursor is moved to the first unprotected location on the new page when in forms mode.
Prev Page	ESC V	Displays the previous 24 rows of memory (until the first row of memory is located at the top of the display). The cursor is moved to the first unprotected location on the new page when in forms mode.
Memory Lock	ESC l	Turn on memory lock (overflow protect).
	ESC m	Turn off memory lock. Refer to the User Manual for additional information on Memory Lock.

TABS

SETTING TABS. To set a tab, move the cursor to the desired column and send ESC 1. Once a tab is set, the tab function or  key can be used to move the cursor to the next tab setting. In Forms Mode, previously set tabs are ignored; however, when Forms Mode is turned off, previously set tabs are in effect.

USING TABS. Once tab positions have been set you can tab in the same manner that you would on a typewriter. You can even tab backwards to the previous tab position by sending ESC i. When you are at the first tab position in a line and you backtab, the cursor moves to the last tab position in the previous line. Once the cursor has reached the first tab position in the first line of memory, no further backtabbing movement can be made.

CLEARING TABS. You can clear individual tabs by moving the cursor to the tab position and send ESC 2. All of the tabs can be cleared at once without having to position the cursor by sending ESC 3.

MARGINS

You can set the left and right margins to make the entry of data easier. When the terminal is turned on or a full reset

performed, the margins are set at columns 0 and 79. This gives a full 80 character line. You can define new margins as follows:

LEFT MARGIN. Move the cursor to the desired left margin setting. Send ESC 4.

RIGHT MARGIN. Move the cursor to the desired right margin setting. Send ESC 5.

The terminal will beep when you are eight characters from the right margin. When the right margin is reached, the cursor will move to the left margin of the next line.

Example: Set the margins for a 40 column page centered on the screen.

Move the cursor to column 20 and set the left margin. Move the cursor to column 59 and set the right margin. Place the cursor back at column 20 and begin sending data.

$\underbrace{\text{ESC } \& \text{ a } 20\text{C}}_{\text{position cursor}} \quad \underbrace{\text{Esc } 4}_{\text{set margin}} \quad \underbrace{\text{Esc } \& \text{ a } 59\text{C}}_{\text{position cursor}} \quad \underbrace{\text{Esc } 5}_{\text{set margin}}$


```

                column numbers
    2           3           4           5           6
    0           0           0           0           0
  
```


This is an example using margins to control data entry.

Margins are cleared or changed by setting new margins (or a full reset) or by entering forms mode, where the margins are reset to columns 0 and 79.

EDIT OPERATIONS

The terminal allows you to edit data displayed on the screen. This can be done by simply overstriking the old data. In addition, several edit operations are available. These edit operations are listed in table 2-2.

INSERT CHARACTER WITH WRAPAROUND

You can insert characters **with** wraparound by sending ESC N. This will cause the  indicator to blink. While

in this mode characters that overflow a line due to insertion are moved to the next line. Sending ESC R returns the terminal to normal operation.

If the current line is full and additional characters are inserted, they will push characters from the end of the first line to the beginning of the next line. If the second line becomes full while the cursor is still in the first line, a blank line will be inserted between line one and two. The characters overflowing line one will then be entered on the new line.

DELETE CHARACTER WITH WRAPAROUND

When characters are deleted using ESC O, one character from the left margin on the next line is moved up to the right margin of the line containing the cursor. If the next line is blank, no wraparound is performed.

When margins are used together with the Delete Character and wraparound operations, the characters to the right of the cursor are moved as shown in figures 2-3 and 2-4.

Table 2-2. Edit Operations

FUNCTION	CODE	DESCRIPTION
Insert Line	ESC L	The line containing the cursor and all lines below it are rolled down one line. A blank line is inserted where the line containing the cursor was. The cursor is moved to the left margin of the blank line.
Delete Line	ESC M	The line containing the cursor is deleted. The lines below the cursor are rolled up and the cursor is positioned at the left margin.
Insert Character	ESC Q	Turn on Insert Character Mode (and indicator). New characters will be inserted in the line at the current cursor position. Characters that are moved past the right margin are lost.
Insert Character with Wraparound	ESC N	Turn on Insert Character with Wraparound (indicator blinks). Characters extending beyond the right margin are wrapped to the next line. Refer to the User Manual for additional information.
	ESC R	Turn off Insert Character Mode (and indicator).
Delete Character	ESC P	The character at the current cursor position is deleted. Characters to the right of the cursor are moved one column to the left (see figure 2-2).
Delete Character with Wraparound	ESC O	The character at the cursor is deleted. Characters from the next line are wrapped to the end of the current line (see figure 2-3).

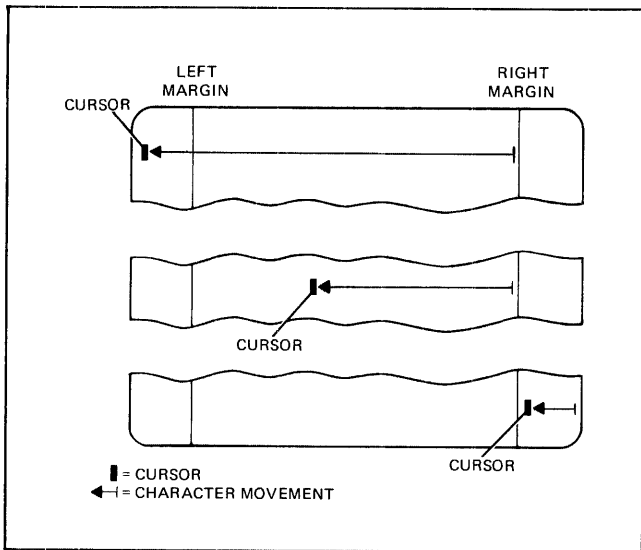


Figure 2-3. Character Delete With Margins

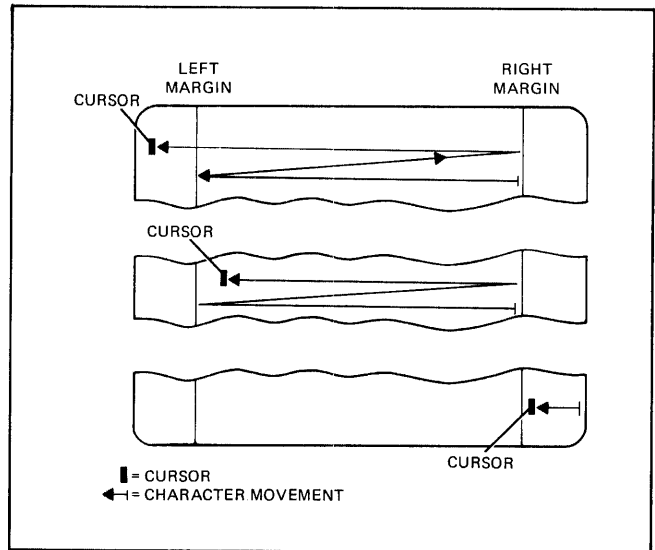


Figure 2-4. Character Delete With Wraparound

MOVING TEXT BLOCKS

You can move blocks of text or data using Memory Lock.

Example: In the following text, move the paragraphs into the proper order. The current top of screen is Row 1 of display memory.

Initial order:

- (Top of screen) 3. This is paragraph 3. It should be last in the group.
 2. This is paragraph 2. It should be second.
 1. This is paragraph 1. It should be first (blank line)

Step 1. Position the cursor in the first line of paragraph 2.

Step 2. Turn on Memory Lock.

Step 3. Roll up the display until the remaining paragraphs have rolled up under the cursor position and off the screen (4 lines).

Step 4. Turn off Memory Lock.

Step 5. Home the cursor.

`ESC & a 4R` `ESC l`
 Position cursor Turn on
 Memory
 Lock

`ESC S ESC S ESC S ESC S`
 Roll display up four lines

`ESC m` `ESC h`
 Turn off Home
 Memory cursor
 Lock

The display should appear as follows:

- (Top of screen) 2. This is paragraph 2. It should be second.
 1. This is paragraph 1. It should be first.
 3. This is paragraph 3. It should be last in the group.

Step 6. Now move paragraph 1 by positioning the cursor in the first line of paragraph 1 and turning on Memory Lock.

Step 7. Roll up the display until the cursor is in the first line of paragraph 3.

Step 8. Turn off Memory Lock and home the cursor. The paragraphs should now be in order.

`ESC & a 3R` `ESC l` `ESC S ESC S` `ESC m` `ESC h`
 Reposition Turn on Roll display up Turn off Home
 Cursor Memory 2 lines Memory Cursor
 Lock Lock

FORMS MODE (FORMAT MODE)

In Forms Mode the terminal prevents you from overwriting or transmitting data in protected fields. Forms mode is normally entered under control of the computer or through commands recorded on a cartridge tape. Forms Mode is turned on by sending ESC W (the cursor is homed to the beginning of the first unprotected field). Normal operation is returned with ESC X (the cursor remains in its present position).

PROTECTED FIELDS

Fields can be protected so that displayed data cannot be overwritten or sent to a computer. When the terminal is placed in "Forms Mode" (Format Mode) all character positions on the screen are protected except those fields that have been specifically defined as "unprotected" or "transmit only".

UNPROTECTED FIELDS

Data can be written into unprotected fields in the normal manner. After reaching the end of an unprotected field, the cursor moves to the beginning of the next unprotected field. The tab functions can be used to move from one unprotected field to the beginning of the next unprotected field. ESC i causes the cursor to be positioned at the beginning of the previous unprotected field. Fields are defined as "unprotected" by using ESC [at the start of the field. ESC] or the end of the line is used to end the field.

In the following figure only the fields shown in white are unprotected or transmit only. Even if the operator moves the cursor to a protected field and types a character the cursor will move to the nearest unprotected field before displaying the character.

FORM #1876R					
Vendor Name		Address		City	State
PACIFIC TOOL INC		1273 CRECENT WAY		SAN JOSE	CALIFORNIA
Zip		Purchase And Assembly Details		Post Ref	Cost
95131					
Voucher	Date	Units			
07	16	1976	98	FINISHED STEEL CASTINGS	874738 65.88
03	19	1976	749	TAPE TRANSPORT BACKPLATES	875483 9753.88
02	28	1976	13	MILLED FLANGE ASSEMBLY	748563 877.44
	19				
	19				
HEBELT BAYARD		INITIATED BY		H.C. DOUGLAS	DATE 04 14 1976

Example: Define column 1 through 9 of line 3 as "Unprotected".

- Step 1.** Position the cursor at column 1 in line 3.
- Step 2.** Send ESC [.]
- Step 3.** Move the cursor to column 10 of line 3.
- Step 4.** Send ESC].

Now try turning on Forms Mode (ESC W) and sending data. Note that data can only be entered into the unprotected field. (Remember to turn off Forms Mode with ESC X.)

TRANSMIT ONLY FIELDS

It is often desirable to be able to return fixed data used as labels or headings to the computer. Transmit only fields are similar to protected fields except that they are sent to a computer along with the data that you enter. Normally data can only be entered in unprotected fields. But by positioning the cursor in the transmit only fields (using the cursor functions), you can also enter data into transmit only fields. The tab functions skip over transmit only fields. After reaching the end of the transmit only field the cursor moves to the beginning of the next unprotected field. Fields are defined as "transmit only" by using ESC { at the beginning of the field. ESC } or the end of the line will end the field.

Example: Continue the previous example and define column 11 through 14 of line 3 as transmit only.

- Step 1.** Turn forms mode off (ESC X).
- Step 2.** Position the cursor at column 11 line 3.
- Step 3.** Send ESC {.
- Step 4.** Move the cursor to column 15 in line 3.
- Step 5.** Send ESC]

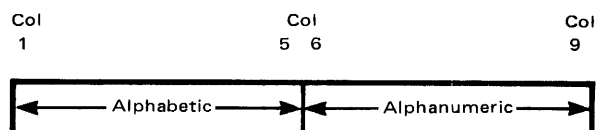
Position the cursor in column 0 and turn on Forms Mode (ESC W). Try typing data. Note that the cursor moves over the Transmit Only field without entering data.

DATA CHECKING


While in Format Mode the terminal can test data in unprotected and transmit-only fields to make sure that it is numeric or alphabetic. If a field is defined as numeric and an alphabetic character is entered the terminal will beep and the keyboard will lock. This condition can be cleared by pressing . You can then continue entering data. Data checking fields are defined by beginning the field with one of the following sequences:

- ESC 6 — begin alphabetic field (A thru Z, a thru z, space only).
- ESC 7 — begin numeric field (space, 0 thru 9, -, +, ., and ,)
- ESC 8 — alphanumeric field (all keyboard characters)

Example: Define columns 1 through 5 on line 4 to be alphabetic and columns 6 through 9 to be alphanumeric.






- Step 1.** Turn off forms mode (ESC X).
- Step 2.** Position the cursor at column 1 of line 4.
- Step 3.** Send ESC [to define the beginning of an unprotected field.
- Step 4.** Send ESC 6 to define an alphabetic field.
- Step 5.** Move the cursor to column 6 of line 4.
- Step 6.** Send ESC 8 to define normal alphanumeric data.
- Step 7.** Move the cursor to column 10 of line 4.
- Step 8.** Send ESC] to end the unprotected field.
- Step 9.** Turn on forms mode (ESC W).

When a number is typed in the alphabetic field the keyboard is locked, the terminal beeps, and the cursor remains under the invalid character. Press the  key to unlock the keyboard. The operator can then make the correct entry.

The numeric character may be left in the alphabetic field by moving the cursor to the next character position using the cursor control keys. This has the effect of overriding the data check.

CAUTION

Deleting characters while in Forms Mode can destroy the data checking field or alter the unprotected field length.

Use  (ESC J) or   (ESC K) to delete information.

TABBING

Tabs are automatically set at the beginning of each unprotected field when Forms Mode is turned on; any tabs set previously are ignored. When Forms Mode is turned off, any previously set tabs are reinstated. Tabs cannot be set within any unprotected field.

EDITING

While in Forms Mode, the unprotected fields can be edited (inserting and deleting characters). The INSERT LINE and DELETE LINE functions are disabled in Forms Mode.

INSERTING CHARACTERS. Characters may be inserted in any unprotected field by turning on Insert Character Mode (ESC Q). Characters received or typed are inserted at the cursor position. Characters moved out of the end of the unprotected field are lost.

Insert Character with Wraparound acts the same as insert character without wraparound explained above (the wraparound function has no effect).

DELETING CHARACTERS. Characters may be deleted in any unprotected field by the Delete Character function (ESC P). The character at the cursor position is deleted and all characters to the right of the deleted character in the field are moved left one column.

Delete Character with Wraparound acts the same as delete character without wraparound explained above (the wraparound function has no effect).

Characters may be deleted from the current cursor position to the end of the field by sending ESC K (clear to end of line). Also, characters may be deleted from the current cursor position to the end of the last field by sending ESC J (clear display).

BUILDING THE FORM

Appendix A contains a method for building forms using the cartridge tapes and soft keys.

SENDING DATA TO THE COMPUTER.

Refer to "Block Mode", page 5-9.

DISPLAY ENHANCEMENTS

The standard terminal can display data using inverse video (black on white). In addition, if your terminal has the 13231A Display Enhancement accessory you can also use half bright, underline, and blinking characters. Each character position on the screen can be displayed with various combinations of these features.

- **Half Bright** — characters are displayed at half intensity (grey).
- **Underline** — an underline is displayed below the normal character.
- **Inverse Video** — the screen is white and characters are black.
- **Blinking** — characters including the inverse video, underline, and half bright features blink.

The display enhancements are used by assigning one or more of them to a field. The selection sequence is: ESC & d <enhancement character>.

The enhancement character (@, A through O) is used to select the combination of display enhancements to be assigned to the field. The following table lists the enhancement character for each of the combinations. The field is ended by selecting another enhancement, the end of the current line, or by ESC & d@.

	@	A	B	C	D	E	F	G	H	I	J	K	L	M	N	O
Half-Bright									X	X	X	X	X	X	X	X
Underline					X	X	X	X					X	X	X	X
Inverse Video			X	X			X	X			X	X			X	X
Blinking		X		X		X		X		X		X		X		X
End Enhancement	X															

Example: Define columns 10 through 14 of line 5 to be inverse video and blinking.

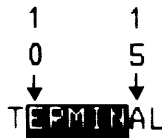
Step 1. Position the cursor at column 10 in line 5.

Step 2. Send ESC & d C

Step 3. Move the cursor to column 15 in line 5.

Step 4. Send ESC & d @ (this ends the enhancements). The field should be white.

Step 5. Send the word TERMINAL beginning in column 9 of line 5. It should appear as shown below. (If your terminal does not have the 13231A accessory installed the characters will not blink.)



ALTERNATE CHARACTER SETS

The terminal can display up to four different character sets. Each character set can contain up to 128 characters or symbols. In addition to the Math, Line Drawing, and Large Character sets available as options, you can create character sets tailored for special applications. Contact your nearest Hewlett-Packard Sales Office for additional information on special character sets.

Switching from one character set to another can be done on a character-by-character basis. For example, a character from the Math Symbol Set can be displayed next to characters from the Roman set. This is done by defining one or more character positions in a line to be from alternate character sets. (Each group of characters can be thought of as a field.)


NOTE

The following discussion assumes that the Math and Line Drawing character sets are present and are installed as alternate sets A and B respectively.

SELECTING ALTERNATE SETS

To use optional character sets, first select the character set to be used as the alternate. (With the terminal in its initial state, character set A is defined to be the alternate.) An alternate set is selected with the following sequence:

Esc) <set> where set = @ or
A or
B or
C

Note that if @ is used, the Roman or basic terminal set would be selected as the alternate. To find out which character set corresponds to @, A, B, or C, generate the test pattern by pressing the  key). This displays the order of the character sets as shown below.

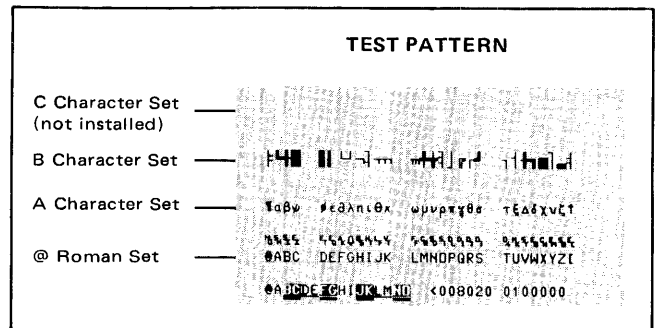


Figure 2-5. Character Set Locations

USING ALTERNATE SETS

Once the alternate character set is defined, you can switch from the Roman to the alternate set with a N^c (SO).

The terminal automatically returns to the base or Roman set at the end of a line. To return to the base set within a line, send a O^c (SI). This means that you must send another N^c to turn on the alternate set if it extends to the next line.

Example: Define the Math Set as the alternate character set.

From the test pattern the Math Symbol Set is found to be the A alternate character set.

An alternate set is selected with the following sequence:

ESC) A

To display AαBβ send the following sequence:

A N^c A O^c B N^c B

The screen should display AαBβ:

AaBβ

Once a field has been defined as from the alternate set the field moves with the display. To change to a different alternate character set another ESC) <set> sequence must be sent.

Once a field in display memory has been defined as an alternate character field, it will continue to display alternate characters whenever data is written in the field until the terminal is reset.

The Math Set is useful for applications requiring the use of equations or formulas. The elements of the optional Math Symbol Set are shown in figure 2-8. An example of the use of the Math Set is shown in figure 2-6.

$$\iiint_0^{\infty} \Psi * \begin{bmatrix} -h & \partial \Psi \\ 2\pi i & \partial t \end{bmatrix} dv = \iiint_0^{\infty} \Psi * E \Psi dv$$

Figure 2-6. Example Using the Math Set

The Large Character set allows you to create alphabetic characters that are three times the size of normal characters. The elements of the Large Character set are shown in figure 2-9. An example of how to use the Large Character Set to build the character "B" is shown in figure 2-7. Table B-16 in Appendix B shows the keys required to build each character. Appendix A gives a program to build each character.

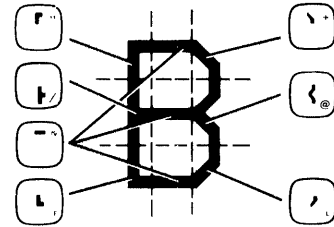
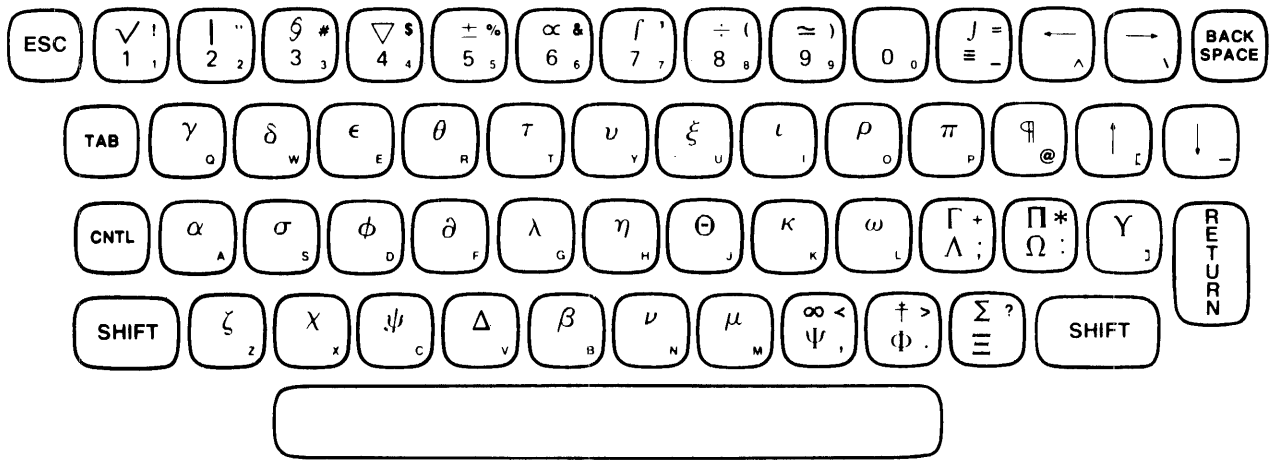
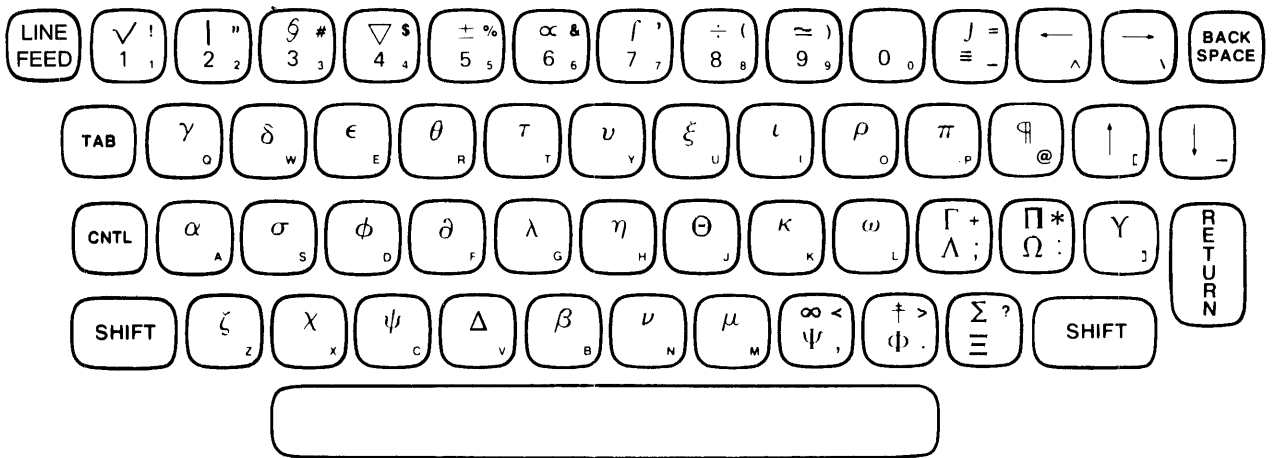


Figure 2-7. Example Using the Large Character Set

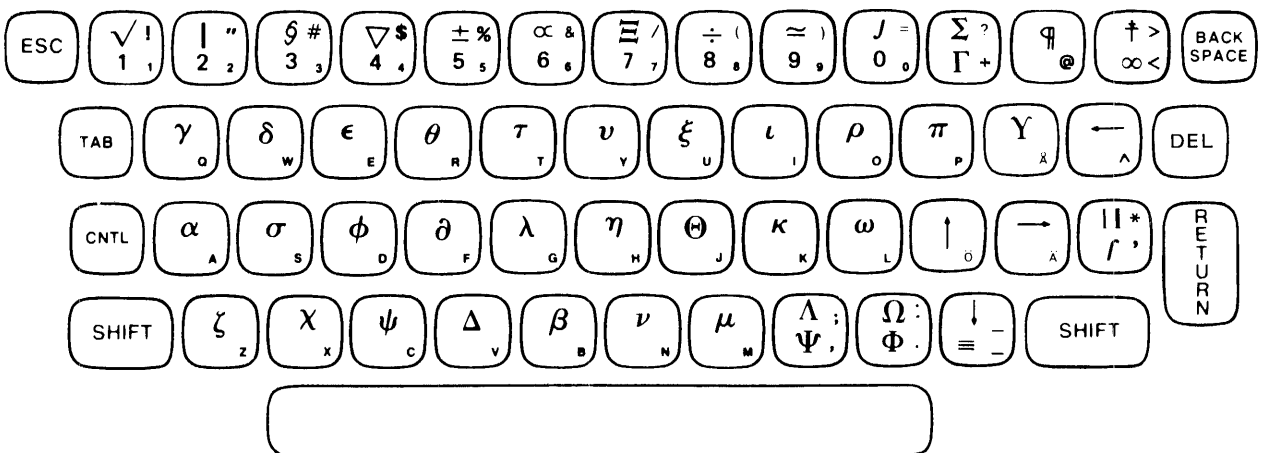
The Line Drawing Set provides a limited graphics capability. Simple line drawings and fairly complex forms for data entry applications can be generated. The elements of the optional Line Drawing Set are shown in figure 2-10. Figure 2-11 shows how the line drawing set can be used to build a data entry form.



HP 2645A

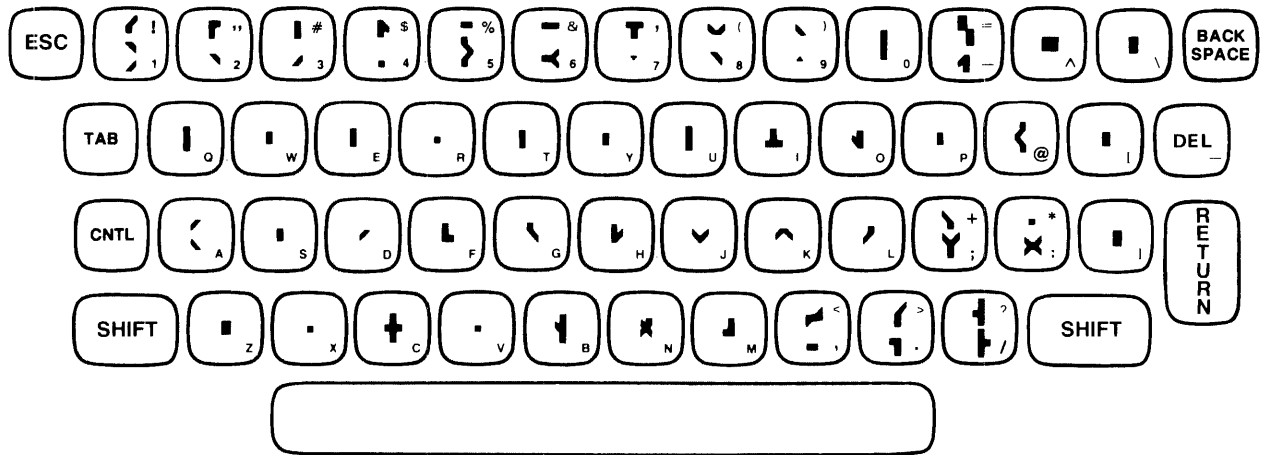


HP 2641A

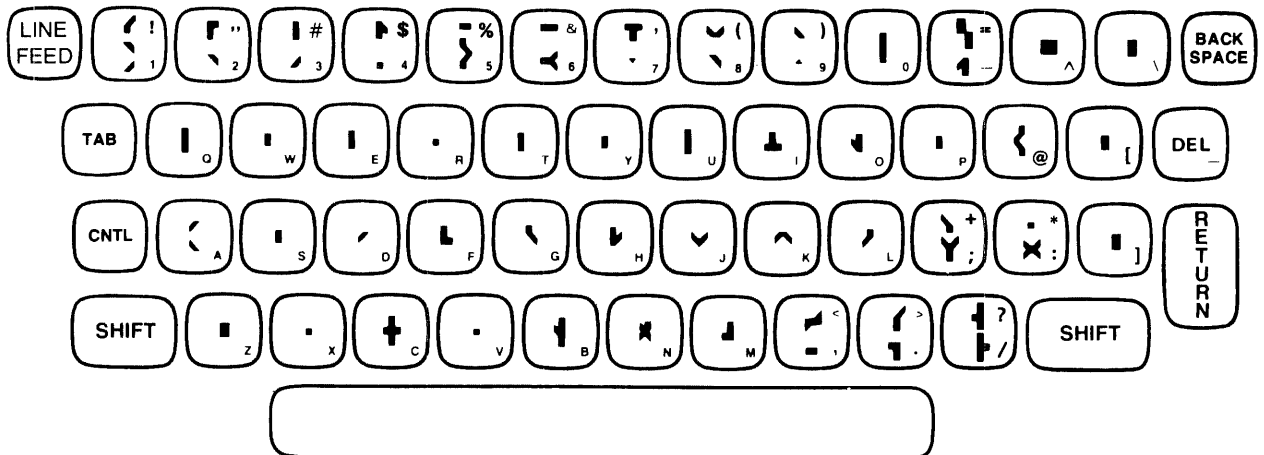


HP 2645S

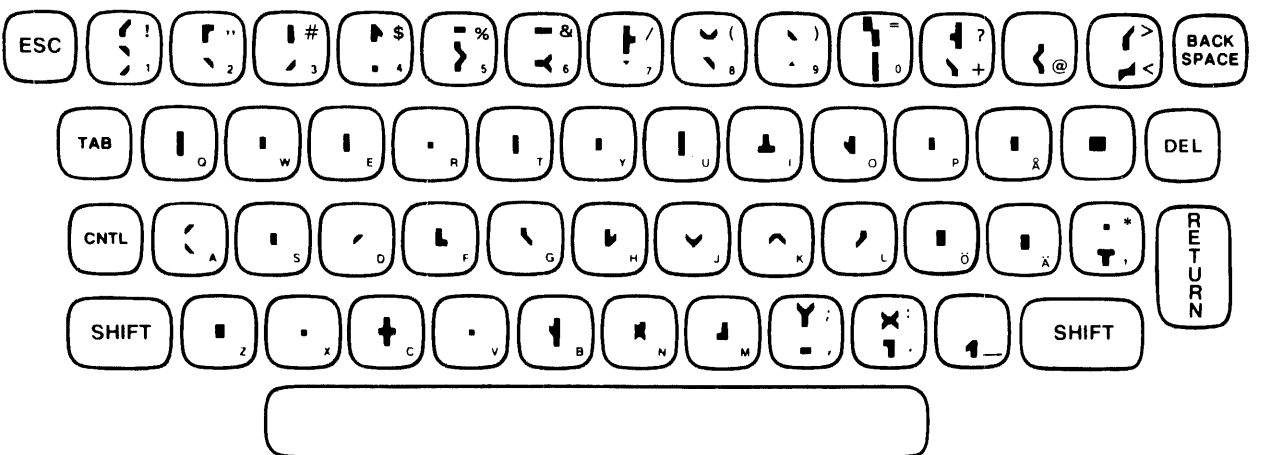
Figure 2-8. Math Set Elements



HP 2645A

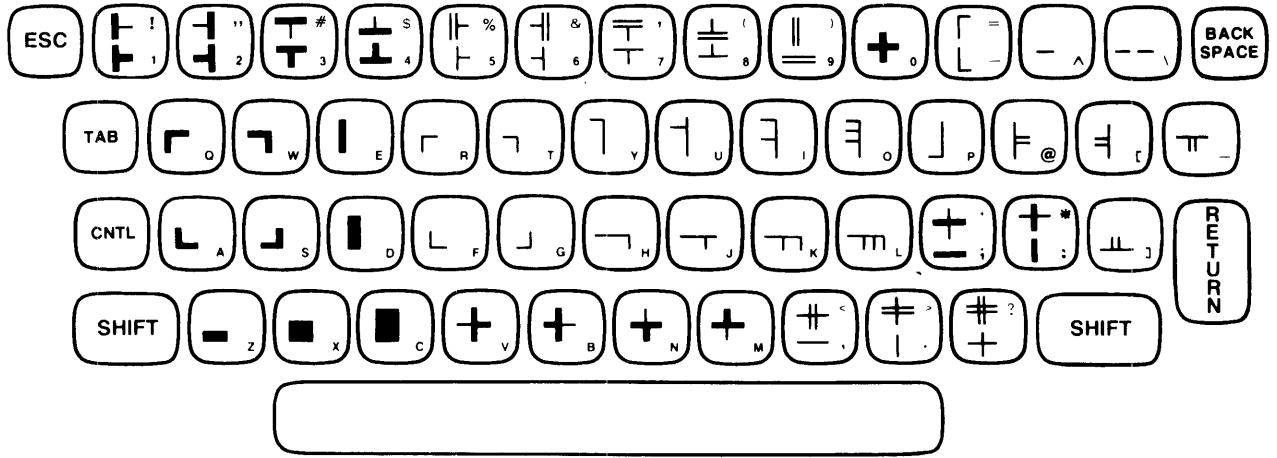


HP 2641A

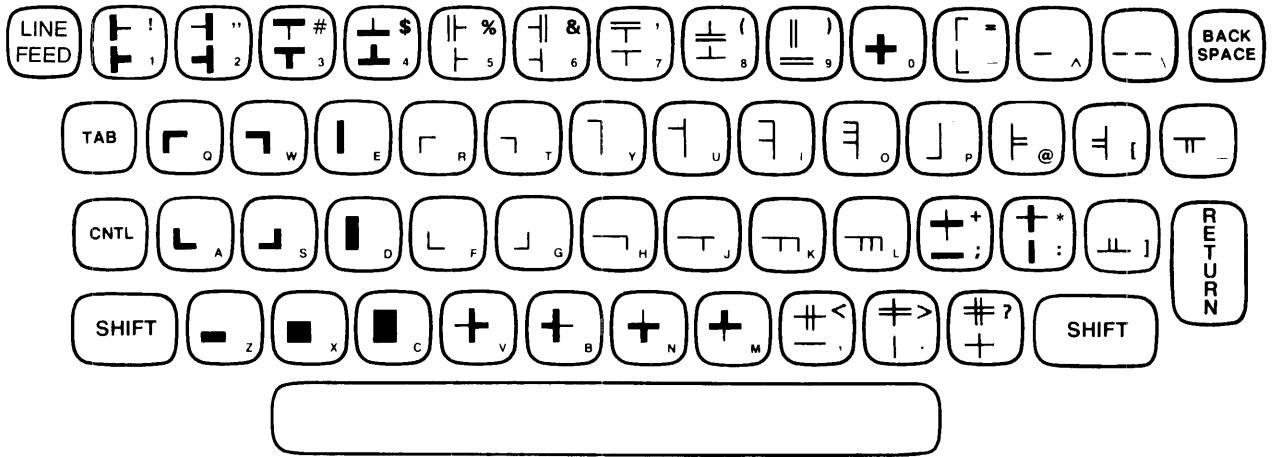


HP 2645S

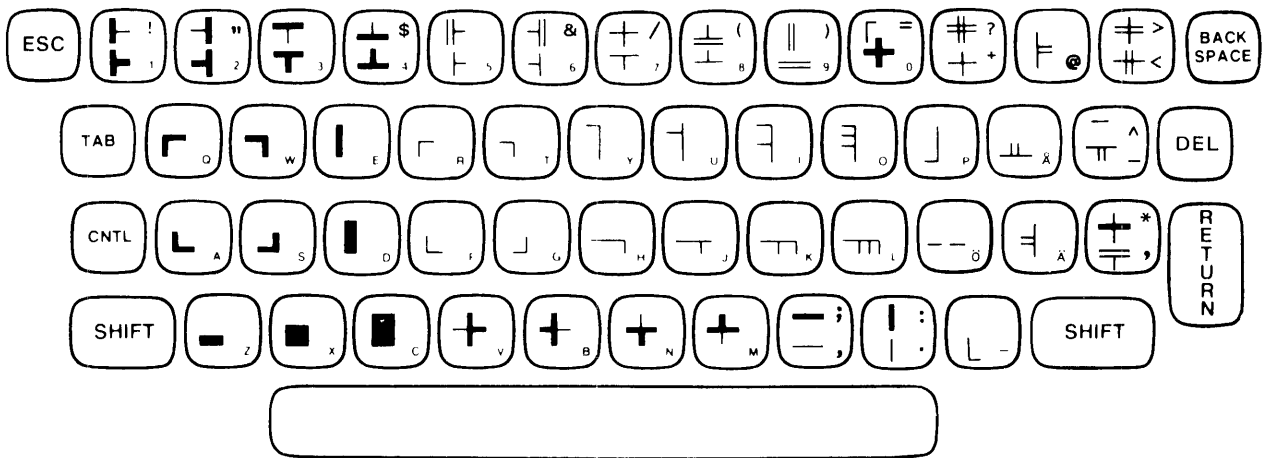
Figure 2-9. Large Character Set Elements



HP 2645A



HP 2641A



HP 2645S

Figure 2-10. Line Drawing Set



The figure shows a terminal window with a form titled "FABRICATED STOCK DRAWING ASSIGNMENT". The form has several columns: "STOCK NO." (with sub-columns "XXX" and "YYYYY"), "SPECS. DRAWING NUMBER", "PART NAME DRAWING TITLE", "R & D DATES", "REMARKS", and "MFG. SPEC" (with sub-columns "A", "B", "C", "D"). The form is surrounded by various control symbols in rounded rectangles, including arrows, underlines, and other symbols, some with subscripts like 0, 1, 2, 3, 4, 5, 6, 7, 8, 9, and letters like T, W, L, A, B, C, D, E, F, G, H, I, J, K, L, M, N, O, P, Q, R, S, T, U, V, W, X, Y, Z.

Figure 2-11. Sample Form

HP 2641A TERMINAL DIFFERENCES

NOTE

The 2641A terminal does not have an ESCape key, therefore, you must press

  to create the escape function.

EDIT OPERATIONS

When the 2641 terminal is in APL Mode, certain functions operate differently as described below.

FORWARD SPACING. The SPACE bar may be used to forward space over typed characters; blanks are non-destructive (they do not overwrite existing APL characters). The blanks perform a cursor-right function when the terminal is in APL Mode and the cursor is in an APL or overstrike field. If the cursor is in base set (Roman) or in set C, then blanks will overwrite characters unless the SPOW latch is disabled. Note that the special features of APL operation apply only to APL and Overstrike fields during APL mode. Base Set fields and Set C fields are always treated as though the terminal is in ASCII Mode.

BACKSPACING. The BACKSPACE key is used during data input to position the cursor for character overstrikes. If the cursor is in column 0, the backspace function will move the cursor to column 79 of the previous line. This permits overstriking the last character in a line when using the backspace function. The margin settings have no effect. In ASCII Mode, the backspace functions normally.

OVERSTRIKES. Overstrikes are performed by positioning the cursor to the character to be overstruck, then sending the overstrike character. Table B-3 in Appendix B shows the combinations of characters that make up the Overstrike Set. If an invalid overstrike is attempted, the OUT character is displayed.

UNDERLINING. Underlining of any APL or Overstrike character can be accomplished by placing the cursor under the character and overstriking with a shift F (ASCII code for uppercase F). Base Set fields and Set C fields can be underlined by using the underline enhancement escape sequence (refer to "Display Enhancements" in this section). Presently, APL systems allow only the alphabetic APL characters and a few of the special symbols to be underlined although the terminal can underline any APL or Overstrike character.

INPUTTING DATA

CHARACTER MODE. When inputting data in character mode, the overstrikes may be done in any order on the current line. You may type several characters, then backspace as far as necessary to begin generating the overstrike characters, skipping over characters when necessary by using the space bar. (The APL System keeps track of your current cursor position by monitoring the number of backspaces and forward spaces.) When the line is complete, press RETURN to indicate to the system that the line is terminated.

Since blanks do not overwrite existing APL characters on the display and all attempts to overwrite will result in overstriking, the method for input correction is to use the Line Feed (LF) character. You backspace to the character to be edited, then send an LF which effectively erases (according to the APL System) all characters to the right of the point where the LF occurred. The new characters to be typed are appended to the current characters at the point where the LF occurred to complete the meaning of the input data or command.

When using the 2641 with the HP APL\3000, an additional means of input editing is available. The CNTL-Y character (Em) can be used for input correction. When you input CNTL-Y, the HP APL\3000 will send an escape sequence to the terminal to clear the line from the current cursor position. It is an easy matter to append the corrected data to the line. Also, the HP APL\3000 recognizes CNTL-Y as an attention command code which is useful to break infinite loops when running a program.

BLOCK MODE. When operating in Block Mode, the ENTER key is used to input data (as in ASCII Mode) after the data on the screen has been edited (corrections made where necessary and overstrikes generated). Overstrikes are decomposed to their component characters with a backspace character between them. For example, the ϕ character would be sent as [, Bs, \circ . Any number of

overstrikes (up to 80 characters, maximum) may be sent on an input line.

DISPLAY ENHANCEMENTS

The 2641A Terminal has the display enhancement feature as standard equipment. Also, the enhancement characters can be entered in ASCII Mode or APL Mode. When in APL Mode, either the SHIFT key or the CAPS LOCK key must be down when pressing the enhancement character key (A through O) except the @ key.

ALTERNATE CHARACTER SETS

The 2641A terminal has three character sets as standard equipment:

- 64-character Roman base set (Set @)
- 128-character APL set (Set A)
- 64-character APL Overstrike set (Set B)

A 64-character lowercase Roman set can be optionally added. Also, either a Math, Line Drawing, Large Character, or User-Defined character set can be optionally added as Set C.

When the terminal is in ASCII Mode, Set @ is the base set. In APL Mode, Set A is the base set. Alternates may be defined by the user as described earlier in this section.

For block transfers to the CPU in APL Mode initiated by the READ key or ENTER key, whether from the display or cartridge tapes, the default character set to be transmitted will be the APL set (Set A). No shift-in (SI,17 octal) or shift-out (SO,16 octal) characters will be transmitted when APL-only data is transmitted. The overstrike characters will be decoded and transmitted as APL characters separated by a backspace character.




TERMINAL CONTROL FUNCTIONS

SECTION




III

INTRODUCTION

NOTE

The 2641A terminal does not have an  key. Therefore, you must press   (in ASCII mode to produce the code equivalent to the Escape key.




This section describes how to programmatically change most of the terminal's control settings and perform various other control functions. The settings consist of the following:

- Latching Keys , , 
- Keyboard Interface Switch Settings (A-Z)
- Programmable Soft Keys (F1-F8)

When the terminal is powered on or reset, the states of the various keyboard and internal switches are stored in memory. Most of these stored settings can be changed programmatically without physically changing the switch setting. (Note that if the terminal is reset the terminal will return to the physical settings.)

You can select a specific operating configuration from within the application program. This eliminates the problem of requiring the terminal operator to make the settings before continuing with the application program. It also allows individual programs or even subroutines to change terminal configuration for a specific function and then return the terminal to the original state before passing control back to the main program.



LATCHING KEYS



Three of the mechanically latching keys, , , and  can have their electronic state changed programmatically. The escape code sequence is as follows:

ESC & k <state> <key> . . .


where: $\langle \text{state} \rangle$ is $\left\{ \begin{array}{l} 0 \text{ (up)} \\ \text{or} \\ 1 \text{ (down)} \end{array} \right\}$

$\langle \text{key} \rangle$ is $\left\{ \begin{array}{l} \text{a (AUTO LF)} \\ \text{or} \\ \text{b (BLOCK MODE)} \\ \text{or} \\ \text{c (CAPS LOCK)} \end{array} \right\}$

The ESC & k is followed by one or more groups of state and key parameters. The state is a 0 or 1 to indicate that the key is to be up or down respectively. The key is a single letter a, b, or c. The groups can be in any order ( can come before ). The last key letter in the sequence must be capitalized to indicate the end of the sequence.

Example: Set  up and  down.

ESC & k 0 a 1 C

An invalid character (any character other than 0, 1, a, b, or c) will cause the entire sequence to be ignored. An improper setting, (0 b when the terminal is operating in a multipoint configuration) will cause only the invalid setting to be ignored. The rest of the sequence will be accepted. If the terminal is initialized while configured for multipoint operation, the  key will be read as down regardless of the switch's physical setting.

KEYBOARD INTERFACE SWITCHES

The switches on the Keyboard Interface allow you to alter terminal operation for specific applications. Table 2-1 contains a summary of the switches and their function. A more complete description of the switches is given in Section VII, pages 7-18 through 7-24.

The switch settings are made using the following sequence:

ESC & s <state><switch> . . .

where: $\langle \text{state} \rangle$ is $\left\{ \begin{array}{l} 0 \text{ (closed)} \\ \text{or} \\ 1 \text{ (open)} \end{array} \right\}$

$\langle \text{switch} \rangle$ is $\left\{ \begin{array}{l} \text{A through Z} \\ \text{less I and O} \end{array} \right\}$

An invalid character in the sequence will cause the entire sequence to be ignored. The sequence must be terminated with an upper case switch character. A full reset will cause the terminal to return to the physical settings of the switches. Switches S and T cannot be changed if the terminal is configured for Main Channel protocol.

Example: Set switches A, B, and D open and switch C closed.

ESC & s 1 a 1 b 1 d 0 C

In certain operating configurations (i.e. multipoint), some switch settings cannot be changed. If attempted, the new setting for the switch will be ignored.

Table 3-1. Keyboard Interface Switch Summary

SWITCH	POINT-TO-POINT FUNCTION	MULTIPOINT FUNCTION
A	Function key transmission	same
B	Space overwrite latch	same
C	Cursor end-of-line wraparound	same
D	Block mode (Line/Page)	same
E	Paper tape mode	same
F	Fast binary read	(not used)
G	Block transfer handshake	(not used)
H	Inhibit DC2	(not used)
J	Auto terminate	same
K	Clear terminator	same
L	Self-test inhibit	same
M	Reverse CNTL key effect on INSERT CHAR and DELETE CHAR keys	same
N	Escape code transfer to printer	same
P	(not used)	same
Q	(not used)	(not used)
R	Circuit Assurance	Set trailing PAD
S	Main Channel Protocol	(not used)
T	Main Channel Protocol	Output block size
U	CPU break	Output block size
V	Carrier Detect	Continuous carrier
W	Data Comm self-test enable	same
X	Data speed select	same
Y	Transmit LED	same
Z	Parity	same

PROGRAMMABLE SOFT KEYS

The terminal has 8 programmable keys $\boxed{f_1}$ - $\boxed{f_8}$. Each key can be assigned a string of up to 80 characters. The keys can be defined to be used at the terminal only (L), transmitted to the computer only (T), or to be treated as normal keyboard input (N). The keys can be programmed with escape code sequences to control or modify terminal operation. The keys can be used in application programs to create "menu" lists of special commands.

CONTROLLING THE SOFT KEY DISPLAY

You can cause the current soft key assignments to be displayed using the following escape sequence:

ESC j

This will also allow the terminal operator to enter new key assignments from the keyboard. Procedures for entering new soft key assignments by escape sequences are given next in this section. The soft key display is in the following format:

F#type where: # is the key number (1-8)
string

type is $\left\{ \begin{array}{l} \text{L (local only)} \\ \text{N (normal keyboard} \\ \text{operation)} \\ \text{T (transmit only)} \end{array} \right\}$

string is any series of up to 80 characters

The soft key assignments are displayed in place of the normal screen display. Data in display memory is not lost. When the key assignment is completed and the terminal returned to normal operation, the old display is returned to the screen. Normal operation is restored using the following escape sequence:

ESC k

DEFINING SOFT KEYS

The key assignment operation displays the current key assignments in format mode. The attribute and string fields are unprotected allowing the operator to enter new values. In addition, the values are tested during input to make sure that only valid parameter values are used. When the terminal is initialized the soft keys are assigned default values as follows:

$\boxed{f_1}$ = ESC p	$\boxed{f_5}$ = ESC t
$\boxed{f_2}$ = ESC q	$\boxed{f_6}$ = ESC u
$\boxed{f_3}$ = ESC r	$\boxed{f_7}$ = ESC v
$\boxed{f_4}$ = ESC s	$\boxed{f_8}$ = ESC w

NOTE

Adding characters to the soft key string may delete lines in normal display memory if the memory is full.

The soft keys can be loaded by the terminal operator (refer to the *User Manual*) or under program control. It is not necessary to display the current key assignments to enter new ones. Soft Key assignments can be made directly using the following escape sequence:

ESC & f <attribute> <key> <length> <string> ...

where:

<attribute> = 0 (normal)
1 (local only) a (0 is default)
2 (transmit only)
<key> is 1-8 k (1 is default)
<length> is 1-80 l (1 is default)
<string> is the character sequence to be assigned

If a carriage return (CR) is included in the string portion of the soft key definition, the CR will be translated to a CR,LF if the $\boxed{\text{AUTO LF}}$ key is down.

If the transmit only attribute (2) is used, the key will have no effect unless the terminal is set for remote operation.

Also, it may invoke a Block transfer handshake and append the appropriate terminator to the string. (See Appendix C, figure C-2, sheet 2.) The key assignment sequence must be terminated with an upper case character.

Example: Assign "HELLO-C905,PASWRD,3" to the $\boxed{f_1}$ key.

ESC & f 0 a 1 k 1 9 L H E L L O - C 9 0 5 , P A S W R D , 3 C R

After the key assignment in the previous example has been made, a display of the key assignments would appear as follows:

```

f1 N
HELLO-C905 , PASWRD , 3
f2 T
  tq
f3 T
  tr
f4 T
  ts
f5 T
  tt
f6 T
  tu
f7 T
  tv
f8 T
  tw
  
```

CAUTION

Do not include line feeds (LF's) or block terminators (RS/GS) in soft key string (other than at the end of the string) if the soft key assignment is to be stored on cartridge tape from the soft key display.

Terminal Control Functions

SOFT KEY APPLICATIONS

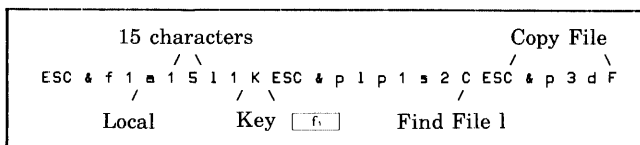
There are many applications of the soft keys. One application is the creation of "menu" operations. For example, the keys can be loaded with the escape sequences to find and read various files on a tape cartridge.

Example: Program the soft keys to find a file on the left tape drive and copy the file to the display. This can be done using the following technique:

ESC & pnp1s2C ESC & p3dF

where: n = the number of the file to be read

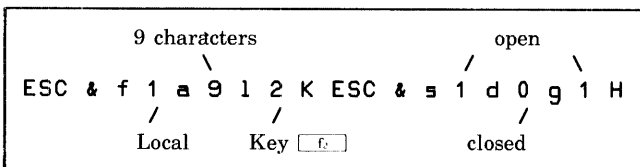
To program the [F6] key to find and display file number 1



The same procedure could be used for the remaining function keys.

Another application would be to change the control settings on the Keyboard Interface to configure the terminal for use with different computer system.

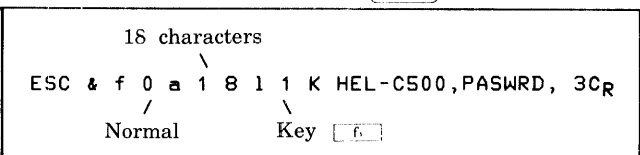
Example: To program the [F6] key to change the settings of Switches D, G, and H to open, closed, and open, the following sequence could be used:



The soft keys can be used to hold log-on, program control, and log-off messages. This makes it easier for the terminal operator to use unfamiliar computer systems.

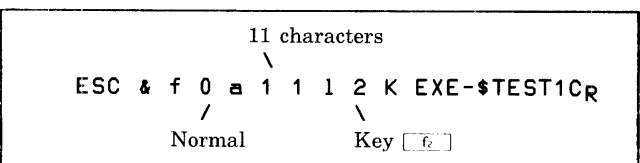
Example: A sample key assignment to log-on to the Hewlett-Packard 2000 Series Timeshare System might be as follows:

[F6] = HEL-C500,PASWRD,3 RETURN



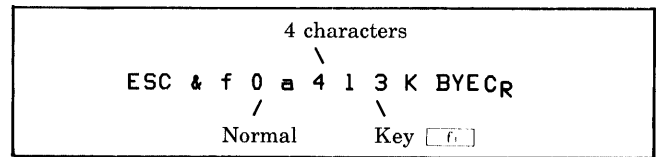
A second key could be used to call and execute a library program:

[F6] = EXE-\$TEST1



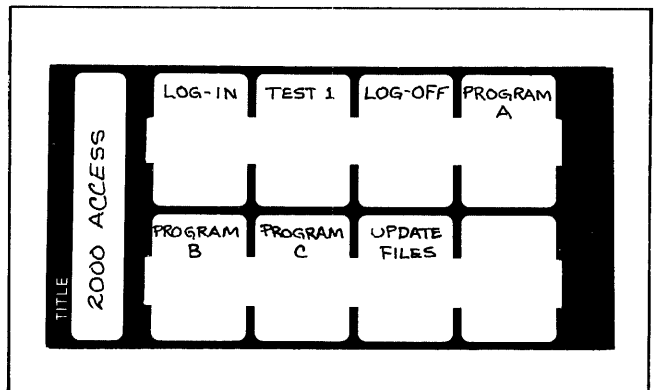
A third key could be used to log off of the system:

[F6] = BYE RETURN



USING SOFT KEY LABELS

The terminal comes with 5 blank soft key templates. These templates can be labeled with the functions assigned to the soft keys. The template can be dropped over the function key group for easy reference.



ADDITIONAL CONTROL FUNCTIONS

In addition to the control settings there are several control operations that can be controlled programmatically. These control functions are as follows:

- Bell — G
- Send Display — ESC d
- Wait — ESC @
- Keyboard Disable — ESC c
- Keyboard Enable — ESC b
- Reset Terminal (Soft) — ESC g
- Reset Terminal (Full) — ESC E
- Turn On Monitor Mode — ESC y
- Terminal Self-Test — ESC z
- Data Comm Self-Test — ESC x
- Modem Disconnect — ESC f
- Program Down Loading — ESC & b or ESC & c

BELL

The G^c character causes the terminal to “beep”. A beep is automatically generated at the end of each unprotected field in format mode and as the cursor passes within eight positions of the right margin.

SEND DISPLAY

The ESC d sequence causes the terminal to send a block of display memory data to the computer. The data sent depends on the Line/Page setting of Keyboard Interface switch D and whether the terminal is in format mode or not.

Data is transmitted beginning at the current cursor position. If the terminal is strapped for page, data is transmitted until the end of the current display. If strapped for line, transmission stops at the end of the current line for non format mode or at the end of the current field if in format mode.

WAIT

The terminal can be made to pause for approximately 1 second by sending it an ESC @. Multiple commands can be used to obtain any desired time period.

KEYBOARD DISABLE/ENABLE

The terminal keyboard can be locked by sending an ESC c. It must then be unlocked by sending an ESC b or by pressing the RESET TERMINAL key.

RESET TERMINAL

A programmatic “Soft Reset” can be made by sending an ESC g to the terminal. A “Full Reset” can be made using ESC E.

Soft Reset (ESC g). A soft reset results in the following:

1. Any error messages present are cleared, the normal display is returned and the keyboard is unlocked.
2. If DISPLAY FUNCTIONS is enabled, it is turned off.
3. Incomplete device selections are cleared. (Previous selections are retained.)
4. If the terminal is set for REMOTE, RECORD operations are ended.
5. Device operations (tape or printer) are stopped. If a tape drive was moving at the time the command was received, the tape will be rewound. In addition, if the tape drive was recording data, an end-of-data mark will be recorded before the tape is rewound.

6. Current transmission of data stops. Data waiting to be sent to the computer is not sent. Partial messages from the computer are lost. The data communications facility is re-initialized.
7. All keyboard lights are turned on for 0.5 seconds.

Full Reset (ESC E). A full reset has the same effect as turning power on and consists of the following:

1. The screen and memory are cleared, then TERMINAL READY is displayed. Format mode, display functions, and all programmable functions including the function keys (F1-F8) are turned off or set to their default values.
2. Device assignments are set to their default values, tapes (if present) are rewound to their load point. (An end-of-data mark is not written.)

NOTE

The CPU must wait 200 milliseconds after issuing ESC E before sending additional data.

MONITOR MODE

Monitor Mode can be turned on by sending ESC y. Refer to Section V for a discussion of Monitor Mode.

SELF-TEST

The Terminal Self-Test can be executed by sending an ESC z. The Data Comm Self-Test can be executed by sending an ESC x. Descriptions of the self-tests are given in section VII.

MODEM DISCONNECT

The terminal can be directed to “hang up” the modem by sending an ESC f. The terminal does this by lowering the CD (Data Terminal Ready) line for 1 second if standard data comm is used or 10 seconds if the terminal is configured for multipoint.

PROGRAM DOWN LOAD

The ESC & b and ESC & c sequences allow special diagnostic programs to be loaded into the terminal and executed. The escape sequence must precede the program to be loaded. This function can be used by HP diagnostics only. The ESC & c functions the same as ESC & b except that the LOADER message is not present on the display.

HP 2641A TERMINAL DIFFERENCES

KEYBOARD INTERFACE SWITCHES

Switch B — space overwrite latch function. When this switch is closed in APL Mode, blanks will not overwrite existing APL characters. When this switch is open in APL mode, blanks will overwrite existing APL characters. This provides an additional editing capability which improves off-line usage of the terminal.

Switch P — APL Printer Bit-Pairing Codes. When this switch is closed in APL Mode, the code output from the terminal to the printer for APL characters will be bit-paired (see table B-3 in Appendix B). When this switch is open in APL Mode, the code output from the terminal to the printer for APL characters will be typewriter-paired (see table B-4 in Appendix B). When the terminal is in ASCII Mode, the code output is bit-paired regardless of the switch setting.

DEFINING SOFT KEYS

In the 2641A terminal, the special function keys can be defined only in ASCII (i.e., if the terminal is in APL Mode, the characters defining the keys will be ASCII characters); however, when a special function key is pressed during APL Mode, the APL characters will be displayed.

APL Overstrike characters cannot be stored in the soft keys; however, the decoded character can be stored (e.g., $S^{B_5}1$ will display \$ when the soft key is pressed).

SOFT KEY APPLICATIONS

Example: To demonstrate the APL overstrike capability on the 2641A terminal, the f_1 key could be programmed as follows:

```
ESC & f 0 a 3 k 7 L h p B5 B5FF CR
```

When the above sequence has been sent to the terminal and the terminal is in APL mode the f_1 key will generate the following:

HP

Example: An APL command can be assigned to the f_2 key. The)LOAD command can be assigned with the following sequence:

```
ESC & f 1 a 2 k 6 L * load (space)
```

When the above sequence has been sent and the terminal is in APL mode, a user could press the f_2 key and then type in a file name. This would load the file into the user's workspace.

Example (2641A only): A sample key assignment for the 2641A to log on the Hewlett-Packard APL\3000 System might be as follows:

```
 $f_1$  = *apl* john.physicslab
```

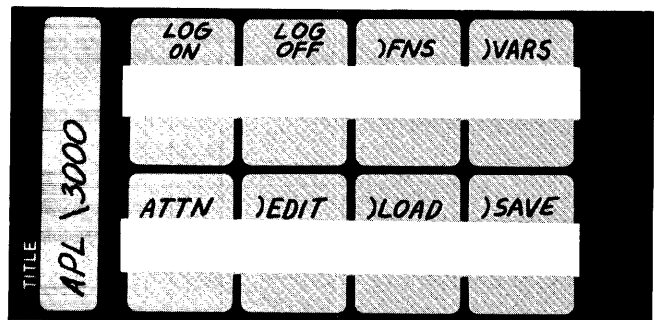
The second key could be used to log off the system.

```
 $f_2$  = *off
```

The f_3 thru f_6 keys could contain some APL commands.

```
 $f_3$  = *fns
 $f_4$  = *vars
 $f_5$  = EM (CNTL Y)
 $f_6$  = *edit
 $f_7$  = *load
 $f_8$  = *save
```

The corresponding soft key template for the above example would look like the following:



ADDITIONAL CONTROL FUNCTIONS

The APL Mode can be turned on and off programatically by sending ESC < (on) or ESC > (off). In APL Mode, the effects of the editing functions (backspace, character insert, clear to end of line, and clear display) differ from the standard ASCII Mode (refer to Section II). Also, two keyboard interface switches (B and P) change their function (mentioned earlier in this section).

DEVICE CONTROL

SECTION

IV

INTRODUCTION

The 2645 I/O devices (display, cartridge tape units, and printer) can be program-controlled from a computer through use of the generalized escape sequences.

The following are examples of the escape sequence used to control a device and/or transfer information.

ESC & p 2s 3d M Transfer all information stored on the right cartridge tape unit to the display.

ESC & p 1u C Rewind the left cartridge tape unit.

ESC & p 1 ^ Fetch the status of the left cartridge tape unit.

ESC & p 2d 25W Write the next 25 bytes sent from the computer on the right cartridge tape unit.

USING THE GENERALIZED ESCAPE SEQUENCE.

The generalized escape sequence for I/O device control is as shown in table 4-1. Items in angle brackets (<>) are replaced by an appropriate numerical value. Items in square brackets [] are optional.



The I/O control escape sequence is initiated by the characters ESC & p and terminated by an upper case character (B, C, D, F, M, P, R, S, U, W, or ^).

Table 4-1. Device Control Escape Sequences

<p>ESC & p</p> <p>[<"from" device code>s] [<"to" device code>d] [<control parameter>p][<device code>u]<control code>c [<device code>]^ [<read control byte>]r [<byte count>]w [<control bit>]b [<control bit>]f [<control bit>]m</p>	<p>Source Device Assignment Destination Device Assignment Device Command Status Read Write Copy (Compare) Record Copy (Compare) File Copy (Compare) All</p>																																				
<p>where:</p> <p>device codes (s, d, u) are:</p> <p>1 = left cartridge tape unit 2 = right cartridge tape unit 3 = display 4 = printer</p> <p>(If no value is specified, previous device assignments are in effect.)</p> <p>control code (c) is:</p> <table border="1"> <thead> <tr> <th>Control Code (c)</th> <th>Default Device</th> <th>Function</th> </tr> </thead> <tbody> <tr> <td>0</td> <td>"from"</td> <td>Rewind</td> </tr> <tr> <td>1</td> <td>"from"</td> <td>Space "p" records</td> </tr> <tr> <td>2</td> <td>"from"</td> <td>Space "p" files</td> </tr> <tr> <td>3</td> <td>"from"</td> <td>Locate end-of-data mark</td> </tr> <tr> <td>4</td> <td>"from"</td> <td>Condition tape</td> </tr> <tr> <td>5</td> <td>"to"</td> <td>Record file mark</td> </tr> <tr> <td>6</td> <td>"to"</td> <td>Record end-of-data mark</td> </tr> <tr> <td>7</td> <td>"to"</td> <td>Test cartridge tape unit</td> </tr> <tr> <td>8</td> <td>"to"</td> <td>Skip "p" records immediately without recording end-of-data mark</td> </tr> <tr> <td>9</td> <td></td> <td>Turn on write-backspace-read mode</td> </tr> <tr> <td>10</td> <td></td> <td>Turn off write-backspace-read mode</td> </tr> </tbody> </table> <p>(If no value is specified, 0 is assumed.)</p>	Control Code (c)	Default Device	Function	0	"from"	Rewind	1	"from"	Space "p" records	2	"from"	Space "p" files	3	"from"	Locate end-of-data mark	4	"from"	Condition tape	5	"to"	Record file mark	6	"to"	Record end-of-data mark	7	"to"	Test cartridge tape unit	8	"to"	Skip "p" records immediately without recording end-of-data mark	9		Turn on write-backspace-read mode	10		Turn off write-backspace-read mode	<p>control parameter (p) is:</p> <p>a positive (+ n), negative (- n), or (unsigned) (n) integer, specifying the number of records or files for (c) control codes 1 and 2.</p> <p>(If no value is specified, + 1 is assumed.)</p> <p>read control byte (r) is:</p> <p>0 = transmit next record 1 = retransmit last record only 2 = send byte count before transmitting next record 3 = send byte count before retransmitting last record read 4 = transmit file 6 = transmit file with byte count before each record</p> <p>(If no value is specified, 0 is assumed.)</p> <p>byte count (w) is:</p> <p>if no value is specified, ASCII is assumed. Data is received until a Line Feed (LF) character or 256 characters (maximum) are received.</p> <p>if a value is specified, binary data is assumed.</p> <p>control bits (b, f, m) are:</p> <p>0 or no integer = copy record (b), file (f), or all (m) from source device to destination device. 1 = compare record (b), file (f), or all (m) on source and destination devices.</p>
Control Code (c)	Default Device	Function																																			
0	"from"	Rewind																																			
1	"from"	Space "p" records																																			
2	"from"	Space "p" files																																			
3	"from"	Locate end-of-data mark																																			
4	"from"	Condition tape																																			
5	"to"	Record file mark																																			
6	"to"	Record end-of-data mark																																			
7	"to"	Test cartridge tape unit																																			
8	"to"	Skip "p" records immediately without recording end-of-data mark																																			
9		Turn on write-backspace-read mode																																			
10		Turn off write-backspace-read mode																																			

Device Control

The characters b, c, f, m, r, w, and ~ (lower case ^) indicate a command is to be performed. All other letters define parameters for the commands. For a given escape sequence, only one command character may be specified. Also, a device operation (other than a status request) should not be initiated before the previous device operation has been completed. For example, after initiating a read command, the data record must be read by the CPU before another device operation is initiated. Otherwise, the read operation may not be executed properly.

During the execution of a command, input from the data communications interface is ignored and the keyboard is locked out except for the  key during device-to-device transfer and read file operations. Pressing the  key will terminate the operation in progress, set a flag to indicate user interrupt to the CPU, and unlock the keyboard. Other operations (such as rewind, condition tape, etc.), cannot be terminated by the return key.

Any errors in the escape sequence will cause the entire sequence to be ignored by the terminal. This may cause the CPU to go into a wait loop if a response is expected from the escape sequence. A programmed time-out can be used to counteract this problem.

SELECTING INPUT/OUTPUT DEVICES

The devices to be controlled are selected by the following escape sequence format:

```
ESC & p    [<"from" device code>s]
           [<"to" device code>d]
```

where device codes are:

- 1 = left cartridge tape unit
- 2 = right cartridge tape unit
- 3 = display
- 4 = printer

Example:

```
ESC & p 2s 1d 4D
```

(Specifies the right cartridge tape unit as the source of the information, and the left cartridge tape unit and printer as destinations for the information).

Only one "from" device may be specified for a given escape sequence. Multiple "to" devices may be specified.

At power on or hard reset, the "preset" assignments are left tape unit for "from" device and right tape unit for "to" device.

CONTROLLING THE DEVICES

The device functions are controlled by escape sequences in the following format:

```
ESC & p    [<"from" device code>s]
           [<"to" device code>d]
           [<control parameter>p][<device code>u]
           <control code>c
```

Examples:

```
ESC & p 2u 0C    Rewind the right cartridge tape
                 unit.

ESC & p 2u - 1p 1C Backspace one record on the right
                  cartridge tape unit.

ESC & p 1u + 3p 2C Forward space three files on the
                  left cartridge tape unit.

ESC & p 1u 6p 2C  Find the sixth file on the left car-
                  tridge tape unit.

ESC & p 2u 3C    Locate end-of-data mark on the
                 right cartridge tape unit.

ESC & p 1u 4C    Condition the tape on the left car-
                 tridge tape unit.

ESC & p 2u 5C    Record a file mark on the right car-
                 tridge tape unit.

ESC & p 2u 6C    Record end-of-data mark on the
                 right cartridge tape unit.

ESC & p 1u 7C    Perform a cartridge tape test on
                 the left cartridge tape unit.

ESC & p -5p 8C   Backspace five records im-
                 mediately without recording end-
                 of-data mark on the "to" device.

ESC & p 9C       Turn on write-backspace-read
                 mode.
```

If the (p) parameter is omitted (control code 1,2, or 8) or zero is specified, a default value of +1 is assumed.

CARTRIDGE TAPES

For the skip record functions (1 or 8), all movements are relative. Backspacing is indicated with a minus (-) sign preceding the p parameter number, while forward spacing is indicated by a plus (+) sign or no sign preceding the number. If a file mark is the last record encountered while backspacing, the tape is spaced forward so that the tape is positioned immediately after the file mark (i.e., just before the first record of the file). Also, the end-of-file mark status bit is set (bit 4 of cartridge tape unit status byte 0). In order to backspace past a file mark, you must specify at least 2 records.

For the locate file function (2), the (p) parameter may be either an absolute file number, or a relative file count

indicated by a plus (+) or minus (–) sign preceding the number. The tape is positioned before the first record of the specified file (i.e., after the file mark of the previous file). Files are numbered from 1 to 255.

Skip/locate functions (1,2,3, or 8) are limited to the bounds of load point and end-of-data (or end of tape). Any attempt to exceed these bounds will cause the command to be aborted, and the appropriate bits in the device status will be set. To append a new file on a cartridge, first find the end-of-data mark (3), then record a file mark (5) to terminate the last file before starting a new file. If a file mark is not written, the new data will be appended to the end of the last file.

Unless the “skip p records immediately” function (8) is used, an end-of-data mark will be written before a skip, locate, rewind, or condition tape operation (0-4) is performed, if the last function performed on the cartridge was a record operation. “Skip p records immediately” inhibits the writing of the end-of-data mark and is intended primarily for write verification in a write-backspace-read operation sequence. After using the “skip p records immediately” function, a file mark must be written on the tape before rewinding the tape. This function should not be used to skip forward on a cartridge on which a record function was the last operation.

DISPLAY

The display ignores all control functions. Any control functions applied to the display will be flagged as executing successfully.

PRINTER

All functions, except the skip lines functions (1), cause one ASCII Form Feed character (octal 14) to be sent to the printer. The Form Feed character will cause some printers to skip to the top of the next page. The skip lines function will cause the printer to skip p lines using the absolute value of p.

Generally, the terminator sent by the terminal in response to the I/O control escape sequence may be a CR(LF), RS, or GS depending on the communications protocol and terminal configuration (refer to section V). Whenever the terminator is specified, the characters CR(LF)/RS/GS will be used to denote the above conditions.

TRANSFERRING DATA FROM DEVICE TO COMPUTER

Data may be transferred from the cartridge tape units or display to the computer by the following escape sequence.

```
ESC & p    [<“from” device code>s]
           [<read control byte>r]
```

Examples:

```
ESC & p 2s 2R  Right tape unit is selected as the new
                “from” device; send byte count before
                sending next record
```


```
ESC & p 0R      Send next record from the “from” device
```

The read control byte has the following meanings:

```
0 = Transmit next record with no byte count
1 = Retransmit last record only
2 = Send byte count before transmitting next record
3 = Send byte count before retransmitting last record read
4 = Transmit file
6 = Transmit file with byte count before each record
```

ASCII TRANSFERS

An ASCII transfer is specified by a read *without* byte count. For reads without byte count (0R, 1R, 4R) an enabling multicharacter transfer trigger (DC1) from your program (following the escape sequence) causes one record to be read and transmitted to the computer.

For reads without byte count (0R,1R), an enabling block transfer from your program (following the escape sequence) causes one record to be read and transmitted to the computer. A CR(LF)/RS/ GS terminator is appended to the end of the record. Any Line Feed characters in a record will not be transmitted if the  key is not latched down. When a file mark is read, the terminal sends an RS (Record Separator) or GS (Group Separator) followed by CR(LF). If the terminal is in BLOCK MODE strapped for page, only RS or GS is sent. The escape sequence must be repeated to read each record from a device.

If a byte count is specified in the escape sequence (2R or 3R), the information is sent in two steps:

STEP 1. When your program issues a block transfer enable (following the escape sequence), the byte count (the number of bytes in the record to be sent) will be transmitted to the computer.

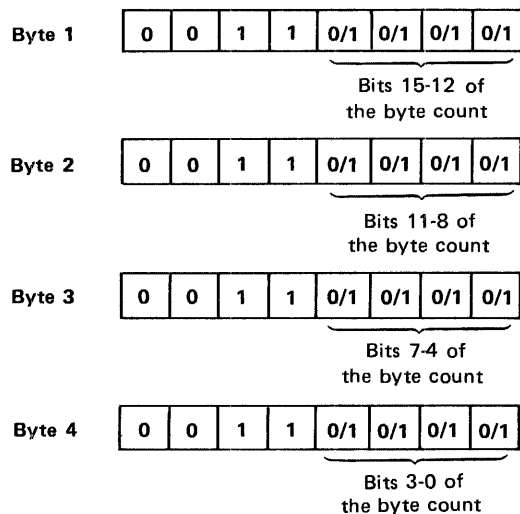
STEP 2. When your program enables the next block transfer from the terminal, the record will be sent to the computer. All characters within the record will be sent (including LFs). No record terminator will be appended to the record. (After the record has been sent, the Request to Send (CA) line from the terminal will be dropped for about 5 milliseconds. This may be used as an interrupt condition for the computer.)

BINARY TRANSFERS

The byte count is sent in binary as four bytes followed by a CR(LF), or an RS/GS if the terminal is in BLOCK MODE, strapped for page.

Device Control

If retransmit is specified (1R or 3R), the previous record read is transmitted. Only the previous record can be retransmitted. Intervening read or write operations are not allowed.



To transfer binary data, the read control byte in the escape sequence must specify a byte count (2R or 3R), and the PARITY switch on the terminal must be set to NONE. If a non-recoverable error occurs, the terminal will send an RS/GS as if a file mark were detected. The type of error can be determined by inspecting the device status.

TRANSFERRING DATA FROM COMPUTER TO DEVICE

A record of data may be transferred from the computer to the cartridge tape units, display, and optional printer by the following sequence:

ESC & p [`<"to" device control>d`]
[`<byte count>w`]

Example:

ESC & p 15W Send the next 15 data bytes from the computer to all "to" devices

The byte count must consist of ASCII numerals. The maximum value is 256. If no byte count is specified, data is accepted by the terminal until a Line Feed character is received or a maximum of 256 characters are received. If a byte count is specified, an ENquiry character (octal 5) must be sent after the escape sequence in point-to-point operation, but before the data bytes. When the terminal responds with an ACKnowledge character (octal 6), then the data bytes may be sent. For multipoint operation, refer to section V.

During the transmission of the data byte, nulls and rub-outs will not be stripped out of the data byte stream, and

the terminal will not respond to an ENquiry character from the computer with an ACKnowledge character.

To use all eight bits of each byte for binary data, no parity (NONE) should be selected for both terminal and the computer.

The keyboard will be locked out until the record has been transferred to all destination devices. Upon successful completion of the operation, the terminal will respond with an S followed by CR(LF)/RS/GS after receiving a block transfer enable. Any non-recoverable write errors terminate the escape sequence immediately, and the terminal will respond with an F followed by CR(LF)/RS/GS instead.

COPYING A RECORD

A record may be copied from one terminal device to another. The escape sequence format is as follows:

ESC & p [`<"from" device codes>s`]
[`<"to" device code>d`]
b

Example:

ESC & p B Copy one record from the "from" device to all "to" devices.

Any file or end-of-data marks on the "from" device are copied to the "to" devices and count as one record each. (No file marks are transferred where the display is the from device.)

An error condition results if an attempt is made to copy a record beyond the available data space of a "to" device (for example, end of tape). Also an error condition results if the "from" device is located at end-of-data.

Upon successful completion of the transfer, the terminal sends an S followed by CR(LF)/RS/GS after receiving a block transfer enable. If an error occurred during the transfer, an F followed by CR(LF)/RS/GS is sent instead.

COPYING A FILE

A file may be copied from one terminal device to another. The escape sequence format is as follows:

ESC & p [`<"from" device code>s`]
[`<"to" device code>d`]
f

Example:

ESC & 2s 4d F Copy one file from the right cartridge tape unit to the printer. The right cartridge tape unit is selected as the new "from" device; and the new "to" device.

The file copy operation starts from the current position on the from device and copies one record at a time until a file or end-of-data mark is detected. Upon completion, the mark is sent to all to devices. If the data space is exceeded on a to device (for example, end of tape), the transfer is terminated and an error condition results.

Upon successful completion of the transfer, the terminal sends an S followed by CR(LF)/RS/GS after receiving a block transfer enable. If an error occurred during the transfer, an F followed by CR(LF)/RS/GS is sent instead.

The terminal operator may interrupt this operation by pressing the key. In this case, the termination response is U followed by CR(LF)/RS/GS.

COPYING TO END OF MEDIUM

All files on a from device may be copied to one or more to devices by using the following escape sequence format:

```
ESC & p    [<"from" device code>s]
           [<"to" device code>d]
           m
```

Example:

```
ESC & p 1s 4d M Copy all data from the left tape unit to
           the printer.
```

The end of medium copy operation starts from the current position on the "from" device to the end of medium (end-of-data mark on the cartridge tape unit, or end of display memory). If the data space is exceeded on the "to" device, the copy operation is terminated and an error condition results.

Upon successful completion of the transfer, the terminal sends an S followed by CR(LF)/RS/GS after receiving a block transfer enable. If an error occurred during the transfer, an F followed by CR(LF)/RS/GS is sent instead. The terminal operator may interrupt this operation by pressing the key. In this case, the termination response is U followed by CR(LF)/RS/GS.

FAST BINARY READ (PROGRAM LOADING)

Binary data can be read directly into the computer without the normal handshake process by using:

```
ESC e
```

The principal use of this escape sequence is for loading of binary data. When the sequence is issued to the terminal, parity is turned off, and transmission begins immediately without waiting for a block transfer enable from the computer. Transmission continues until a file mark is read.

Data is transmitted as read from the source device. No terminators (that is, CR, LF, RS, GS) are appended to the end of record. The mark does not cause an RS (Record Separator) to be transmitted; it serves only to terminate transmission. Instead, the reading of a file mark or end-of-data mark causes two null bytes (all zeros) to be transmitted. If an I/O error occurs, the binary read operation is terminated. Two "all ones" bytes will be sent if the tape is already positioned past the end-of-data mark when the fast binary read operation is invoked. If the Fast Binary Read Strapping Option is set (see page 5-13), the baud rate of the 2645 will automatically switch to 9600 baud. This is valid only if the CPU is capable of receiving at 9600 baud and the CPU's interface is clocked by the 2645 (see Table 7-9, page 7-39).

INDICATING SUCCESSFUL COMPLETION OF A PROGRAM-CONTROLLED FUNCTION

Completion of a device control or transfer of information should be tested by your program as follows:

- Initiate a block transfer from the terminal. (The manner of initiating this block transfer from the terminal varies according to the data communications protocol — see section V.)
- After the terminal has successfully completed the function, it responds to the computer program with an S character followed by a CR(LF)/RS/GS. If the function was a data read operation, (ESC & p R) successful completion is the data.
- If the operation failed, or an error occurred in the process, the terminal responds with an F character followed by CR(LF)/RS/GS. If the function was a data read operation, an I/O failure or end-of-file is indicated by a response of RS, CR(LF), GS.
- If a device-to-device operation was interrupted by you (by pressing), the terminal responds with a U character followed by CR(LF)/RS/GS.

INTRODUCTION

This section describes the terminal's data communications capabilities and operating requirements. The topics include interface specifications, network considerations, point-to-point operation, multipoint operation, and communication configuration status.

CONNECTING TERMINALS TO A COMPUTER

The terminal can be configured to work in a variety of computer applications. Your communication needs can be met by selecting a particular interface, modem, and protocol (communication control program).

NETWORKS

The terminal can be connected in a variety of network configurations. Figure 5-1 illustrates the following configurations:

- Hardwired to a computer (figure 5-1A).
- Hardwired through other terminals to a computer (figure 5-1B).
- Connected to a computer through a modem (figure 5-1C).
- Connected through other terminals to a modem (figure 5-1D).

INTERFACES

The terminal can be used with a variety of communication interfaces. A list of available interfaces and a brief description of each is given in table 5-1. The interfaces are the 13260A Asynchronous, 13260B Extended Asynchronous, 13260C Multipoint Asynchronous, and the 13260D Multipoint Synchronous. A list of some of the capabilities of these interfaces is given in table 5-2.

Once the interface has been selected, the terminal can be configured to operate with a variety of protocols, parities, and data formats. This is done by setting switches or jumpers on the interfaces.

The Installation section contains complete lists of the possible switch settings for each of the interfaces together with brief descriptions of the switches. Also included in

Table 5-1. Data Communication Interfaces

Basic Communications (Point-to-Point)	
13260A	Standard Asynchronous Communications Interface Standard RS232C communications interface.
13260B	Extended Asynchronous Communications Interface provides either standard RS232C or 20 mA current loop communications. It allows split speed and custom baud rates.
Multipoint Communications	
13260C	Asynchronous Multipoint Communications Interface provides asynchronous multipoint communications (patterned after IBM Bisync). It allows several terminals to share the same communication line.
13260D	Synchronous Multipoint Communications Interface provides synchronous multipoint communications (IBM Bisync communications compatible, not text compatible. The terminal uses different character sequences to enable advanced features.) It allows several terminals to share the same communication line.

the Installation section are procedures for setting these switches.

Some of the communication features can be selected from the Keyboard and the Keyboard Interface PCA. Tables 5-3 and 5-4 provide lists of these switches together with brief descriptions.

INTERFACE SIGNALS

The signals available on each of the communication interfaces are listed in the Installation section. This information can be used to verify interface compatibility or to fabricate special interface cables.

MODEMS

The terminal can be used with a variety of modems depending on the requirements of the given configuration or network. Table 5-5 contains a list of modems and the configurations in which they can be used.

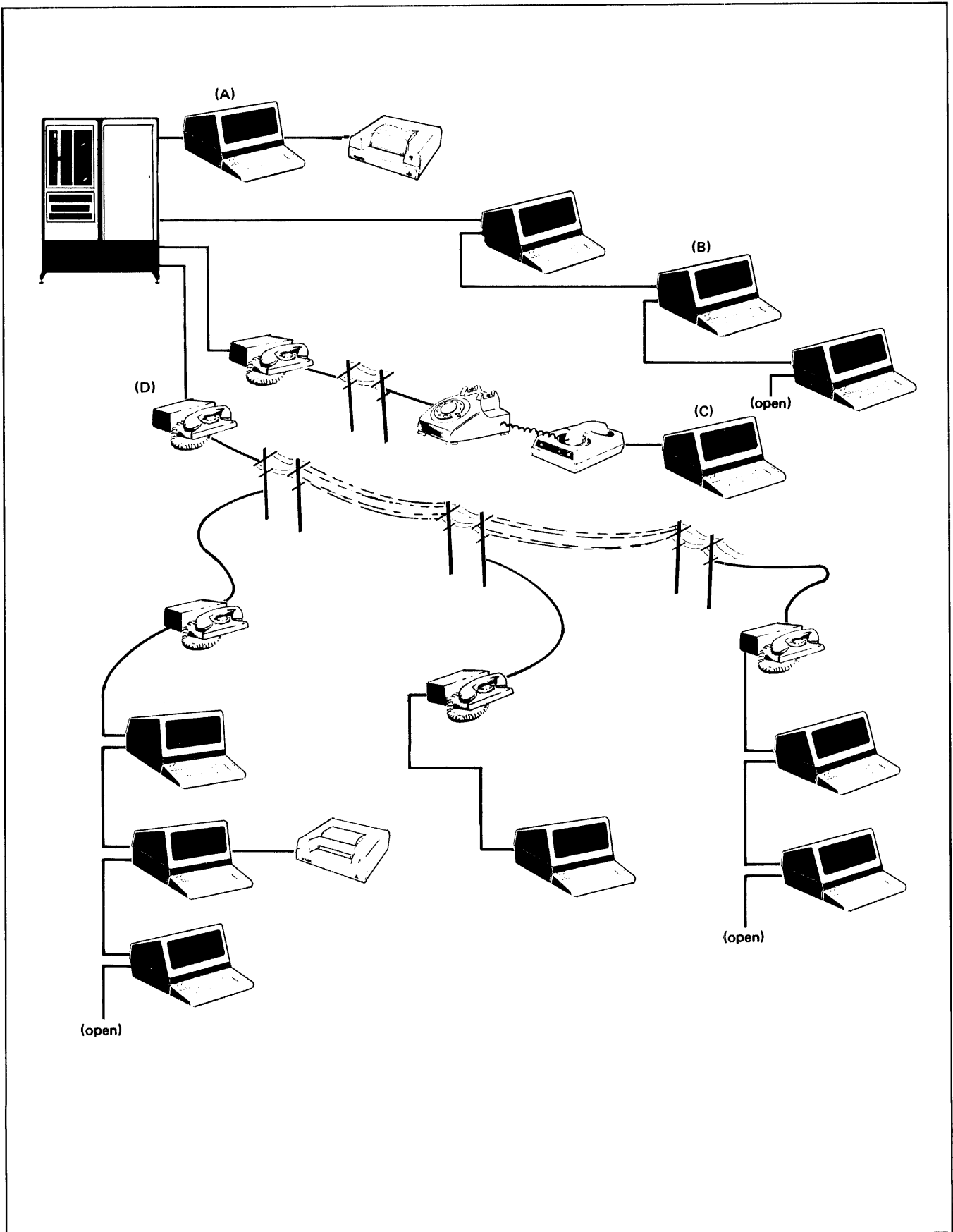
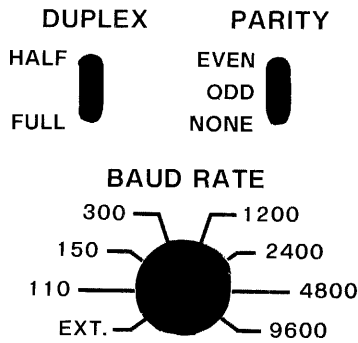


Figure 5-1. Terminal Network Configurations

Table 5-2. Data Communication Interface Capabilities

2645A DATA COMMUNICATIONS FEATURES	13260			
	A	B	C	D
Transfer Rate: 110, 150, 300, 1200, 2400, 4800, 9600 bits per second and external clocking (110-9600) 300, 600, 1200, 1800, 3600, 4800, 7200, 9600 bits per second 2400, 4800, 9600 bits per second and external clocking (300-9600) Custom transfer rates within 1% from 37.5 to 2400 bits per second Split speed transmit/receive capability	X	X	X	X
EIA RS232-C	X	X	X	X
Teletypewriter compatible	X	X	X	X
ASCII	X	X	X	X
EBCDIC			X	X
20mA DC Current Loop		X		
Transmission Modes:				
Character Transfer	X	X		
Block Transfer	X	X	X	X
Half-duplex	X	X	X	X
Full-duplex	X	X		
Asynchronous	X	X	X	
Synchronous				X
Hardwired to computer; dialed (switched) or leased line	X	X	X	X
Modem Compatibility:				
Bell 103A, 202D, 202C, 202S, 202T (Asynchronous)	X	X	X	
Vadic 3400 (Asynchronous/Synchronous)	X	X	X	X
Bell 201A, 201B, 201C, 208A, 208B, 209A (Synchronous)				X
Choice of main channel or reverse channel line turnaround for 202 modems	X	X		
Auto-Answer/Disconnect		X	X	X
Transparency	X	X	X	X
Data Comm. Self-Test	X	X	X	X
Error Checking:				
VRC, choice of parity generation/checking	X	X	X	X
LRC			X	X
CRC-16			X	X
Additional polling protocol features:				
Daisy-chained/multipoint line and modem sharing (up to 32 terminals/line)			X	X
Synchronous polling (IBM Binary Synchronous Multipoint Communication, Bisync)				X
Asynchronous polling (modeled after IBM Bisync)			X	
Group and device addressing; group poll; broadcast			X	X
Variable I/O buffer sizes			X	X
Concurrent or completed block input processing			X	X
Configuration status			X	X
Monitor Mode	X	X	X	X
Driver Mode (option)			X	X

Table 5-3. Keyboard Communications Switches




**BASIC COMMUNICATIONS
DATA COMM SWITCHES**



DUPLEX Switch. HALF: Typed characters are processed by the terminal and transmitted to the computer. FULL: Typed characters are transmitted to the computer and not processed by the terminal until returned from the computer. (This function is ignored in Block Mode.) Not present on terminals with multipoint interfaces.

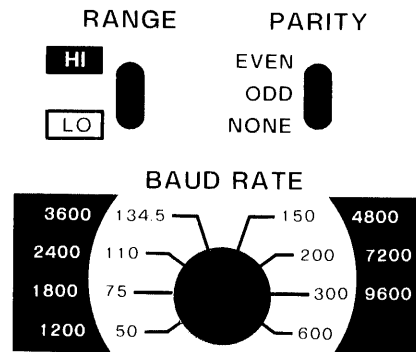
RANGE Switch. This switch is used to select ranges for the BAUD RATE switch (multipoint only).

PARITY Switch. When set to EVEN/ODD/NONE, even/odd/no parity is transmitted for each character. Incorrect parity: a "--" (or a "■" with Option -001) is displayed.

BAUD RATE Switch. Selects data transmission rate of 110, 150, 300, 1200, 2400, 4800, or 9600 baud. EXT: any rate between 110 and 9600 can be selected from an external source. The 110 baud rate uses 2 stop bits per character; all others use one stop bit. In Multipoint configurations the following additional speeds are available: 600, 1800, 3600, and 7200.

 When down the terminal is in Remote (on-line) operation. Otherwise, the terminal is in local (off-line) operation.

 When the terminal is in Block Mode, typed data is displayed but not transmitted to the computer until requested by the computer or until after the  key has been pressed and the computer has responded. Otherwise, the terminal is in Character Mode and data is transmitted as typed. (See "Block Mode". In multipoint configurations the terminal is always in Block Mode, regardless of key position.



**MULTIPOINT
DATA COMM SWITCHES**

 BREAK

In basic communications, transmits a BREAK signal to interrupt computer operation. (Transmits a 200 ms space on the asynchronous data communication line and sets secondary channel low for 200 ms.) In multipoint, clears the output data comm buffers.

 TRANSMIT

The indicator will be lighted when a data link exists for transmission between the terminal and the computer.

 ENTER

On-Line Mode

- Character Mode, Format Off. The entire line containing the cursor is transmitted as a block.
- Character Mode, Format On. Unprotected characters from the cursor position to the end of the unprotected field are block transmitted. The cursor is left at the first character position after the end of the field.
- Block Mode, Format Off. After receiving a DC1 from the computer informs the computer by transmitting a DC2 control character (or DC2 CR(LF) with Line Strapping – see "Strapping Options" that the terminal is ready to transmit characters from the cursor to the end of the line of memory (dependent on Line or Page strapping).¹
- Block Mode, Format On. After receiving a DC1 from the computer, informs the computer by transmitting a DC2 (or DC2 CR(LF) with Line Strapping) that the terminal is ready to transmit line current field, or all unprotected fields from the cursor to the end of memory, each delimited by a unit separator, US (dependent on Line/Page strapping).¹

¹Basic Data Communications only

Table 5-4. Keyboard Interface (PCA) Switch Summary

SWITCH	CHARACTER PROTOCOL	BLOCK PROTOCOL
A	Function key transmission	(not used)
B	Space overwrite latch	same
C	Cursor end-of-line wraparound	same
D	Line/Page mode	same
E	Paper tape mode	same
F	Fast binary read	(not used)
G	Block transfer handshake	(not used)
H	Inhibit DC2	(not used)
J	Auto terminate	same
K	Clear terminator	same
L	Self-test inhibit	same
M	Reverse action of CNTL key with INSERT CHAR and DELETE CHAR keys (wrap function)	same
N	Escape code transfer to printer	same
P	(not used)	same
Q	(not used)	same
R	Circuit Assurance	Set trailing PAD
S	Main/Reverse Channel configuration. (Switches S and T cannot be modified programmatically.)	(not used)
T		Output block size. (Switches T and U cannot be modified programmatically.)
U	CPU break	
V	Carrier detect	Continuous carrier
W	Data Comm self-test enable	same
X	Data speed select	same
Y	Transmit LED	same
Z	Force Parity	same

Table 5-5. Modems

MODEM	DATA RATE (BITS/SEC)	LINE TYPE: DIALED/LEASED	DUPLEX FULL/HALF	WIRES 2/4	REV. CHAN.
Asynchronous					
Bell 103A	300	D/L	H/F	2	No
Bell 202S Bell 202C ITT GH 2052 Nokia DS 9320	1200	D	H	2	Option
Bell 202T Bell 202D	1200 (3)	L	H/F	2/4	Option
Vadic VA3400	1200	D	F	2	No
Synchronous (1)					
Vadic VA3400	1200	D	F	2	No
Bell 201C Bell 201A Milgo 2200 Milgo 2400	2400	D/L (2)	H/F	2/4	No
Bell 208A	4800	L (2)	H/F	4	No
Bell 208B	4800	D	H	2	No
Bell 209A	9600	L (2) (4)	F	4	No
Notes:					
1. Synchronous modems require the internal clock modem option.					
2. Synchronous operation on a leased line requires the switched carrier modem option.					
3. C2 line conditioning allows operation at 1800 bits/sec.					
4. Requires D2 line conditioning.					

COMMUNICATION PROTOCOLS

Control of computer-terminal communications is required for the orderly transfer of data. This control is provided in the form of a protocol or a set of rules and procedures. The protocol used determines who sends and who receives during each phase of communication. In addition the protocol normally provides for an orderly recovery from communication errors.

The protocols available with the terminal allow operation ranging from simple full duplex teleprinter compatibility to bisynchronous multipoint communications. The various protocols can be selected by installing the proper interface and ROM modules. The terminal and the interface can then be configured to meet your specific requirements.

The major characteristics of the available protocols are listed in table 5-6. The following paragraphs discuss each of these protocols.

CHARACTER PROTOCOLS

Character protocols transmit a single character at a time. Data checking, if present, is done on individual characters only (parity). Some configurations allow the transmission of multicharacter groups but no block checks are made. There is no automatic retransmission of data following the detection of a data error. Currently available character mode protocols are Basic, Main Channel, and Reverse Channel.

Table 5-6. Protocol Characteristics

Single Terminal (Character Mode Protocols)	
Basic	Standard communication protocol is teletype compatible or can use the DC1 character to trigger multicharacter transfers.
Main Channel	Communication protocol uses special framing characters to control line turn-around.
Reverse Channel	Uses secondary channel signals to trigger line turn-around.
Multiple Terminal (Block Mode Protocols)	
Multipoint	Uses a polling protocol similar to IBM Bisync to serve multiple terminals on the same line.

Basic Communications is a term used to refer to point-to-point or single terminal communications. The terminal can be connected directly to a computer (hard-wired) or through a modem. In most block applications the terminal can use a simple "handshake" protocol with the ASCII DC1 character. This protocol can be used with Bell 103 or equivalent modems (full-duplex operation). There are two additional protocols available, Main Channel and Reverse Channel. These protocols are normally only used with Bell 202 or equivalent modems (half-duplex operation).

BLOCK PROTOCOLS

Block protocols transmit a block of characters at a time. Data checking is performed on an entire block of data. A separate block check character (BCC) is generated for each block. If a data error is detected, a retry of the data transmission is made automatically. The currently available block protocol is Multipoint.

Multipoint communications is the use of several terminals sharing a single communication line. The terminals can be directly connected to the computer or can be connected through modems. Multipoint communications require a special multipoint protocol. Additional information on multipoint operation is given later in this section.

The remainder of this section provides descriptions and samples of control and data transfer sequences for various protocols. Included are examples of typical single terminal and multiple terminal organizations together with sample communication programs. Detailed flowcharts of the various protocols are given in Appendix C.

CHARACTER PROTOCOLS

The terminal can operate character-by-character as a completely interactive terminal or on a block of data at a time. Block transfers allow data to be composed and edited at the terminal allowing the user to verify and correct data before sending it to the computer.

OPERATING AT HIGH SPEEDS

If the number of characters sent to the terminal in one sequence exceeds 80, the required terminal processing time may cause some of the characters to be lost. (This usually does not occur at data rates of 4800 baud or less.) The symptom of this problem is the appearance of the **█** (delete) or **_** characters.

There are two ways of insuring that this problem will not arise:

- It is possible to use a call-and-answer procedure between the terminal and the computer. If the computer sends an ENQ (octal 5) character after sending 80 characters, the terminal will respond with the ACK (octal 6) after it has processed the characters. The computer can then send the next block of characters. This is the recommended technique.
- Alternately, delays can be inserted in the application or system software after each 80 character transfer from the computer to the terminal. Transmitting NULL characters (octal 0) is one way to accomplish this. Each NULL character has the effect of 4 millisecond delay when operating at 2400 baud, and 2 milliseconds at 4800 baud. As an aid in calculating needed time delays, a list of processing times for various terminal functions is provided in the table 5-7. The times listed are typical and can vary greatly depending on such factors as the number of characters in the terminal memory or on the display, and the current operating mode.

Table 5-7. Terminal Functions

TERMINAL FUNCTION	TYPICAL REQUIRED TIME (MILLISECONDS)
Vanilla Character	0.7
Cursor Up/Down/Left/Right	1.4
Line Feed	1.4
Insert Char	4.5
Delete Char	7.0
Insert Char w/wrap	12.0
Delete Char w/wrap	19.0
Soft Reset (Tapes Stationary)	130
Hard Reset (No Tapes)	159
Forms Mode On	12.0
Forms Mode:	
Home	8.0
Tab	8.0
Back Tab	10.0
Erase to End-of-Line (40 characters)	10.0

CHARACTER MODE

In Character Mode operation (BLOCK MODE key up), the terminal sends characters to the computer as they are typed. This mode of operation can be used for conversational exchanges with the computer.

Example:

```

Computer:   Please type your company name
User types: AJAX

Computer:   What file number would you
            like from the AJAX library?
User types: 12345

and so on  ...
    
```

MULTICHARACTER TRANSFERS

There are certain functions that always result in multicharacter (block) data transfers.

- device input/output and control operations, including tape transfers
- special function keys
- status requests
- cursor sensing
- all transfers while in Block Mode

In order for the terminal to make a block transfer, it must first be enabled and then triggered by the computer. Transfers are enabled by the ENTER or special function keys while the terminal is in Block Mode (see figure 5-2). When a transfer is enabled from the keyboard, the terminal sends a DC2 character to the computer to indicate that a data block is ready for transmission. (This process can be modified by strap settings on the Keyboard Interface, refer to Section VII.) A transfer can also be enabled from the computer by an escape sequence requesting status (ESC ^), cursor sensing (ESC a), or device control (ESC&p...) as shown in figure 5-3.

When the transfer is enabled the keyboard is locked out until the transfer is complete. Enabling sequences should not be entered from the keyboard or cartridge tapes because they will cause the keyboard to be locked until the computer responds with a DC1 character. (If the computer does not respond, a soft reset will cancel the transfer and re-enable the keyboard.)

Once a block transfer has been enabled, it must be triggered by the computer before the block of data is actually sent. The computer triggers the transfer by sending a DC1 character when it is ready to receive the data. The terminal also assumes that it has received the trigger when it is first powered up or fully reset, or when the REMOTE key is pressed (down).

The computer software must support the handshaking process used in multiple character transfers. The DC2 character must be recognized as a request to send data and the DC1 character must then be sent to trigger the transfer after buffers have been allocated to receive the data. Additional software support may be needed depending on your need for terminal or device control. There are straps on the Keyboard Interface that can be used to modify the

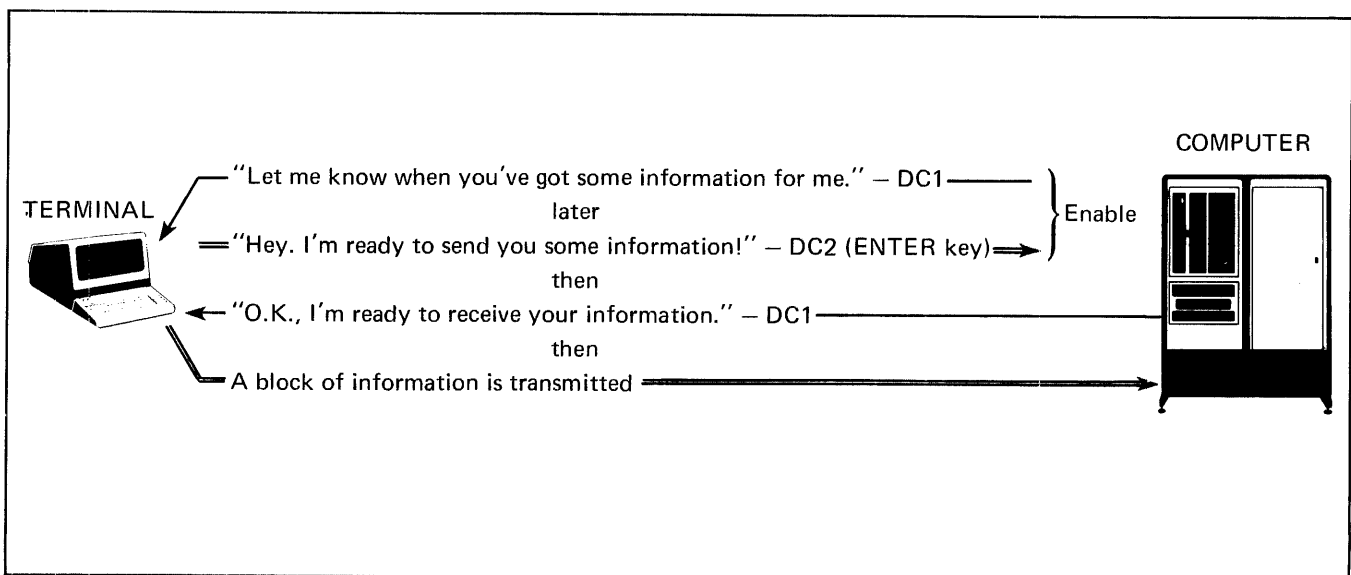


Figure 5-2. Block Transfer Enabled By The ENTER Key

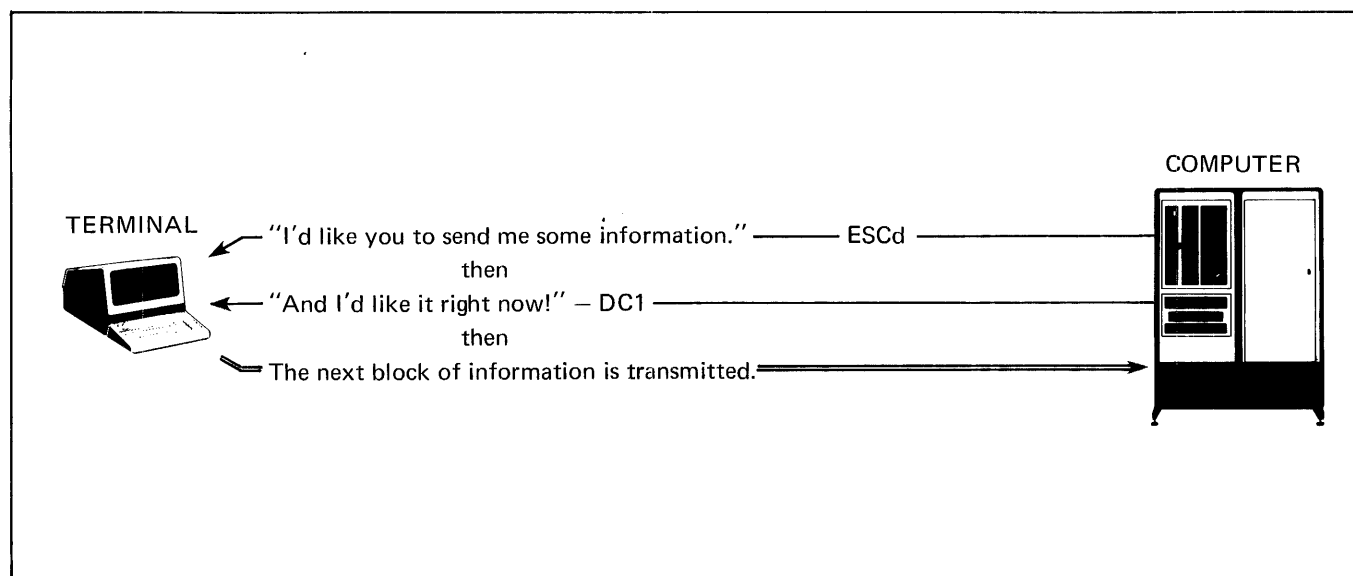


Figure 5-3. Block Transfer Enabled By The Computer

handshaking process. These are discussed later in this section.

NOTE

The computer should not be allowed to echo back information that has been transmitted as a block from the terminal.

BLOCK MODE

When the terminal is in Block Mode (BLOCK MODE key down), characters are not transmitted as they are typed. Instead, the user can input data to the terminal, then edit and correct the data before sending it to the computer using the ENTER key. The data can be grouped into convenient blocks, either lines or pages (refer to the configuration procedures later in this section). Block Mode operation allows you to efficiently utilize computer and communication facilities.

The size of the block of information transferred in BLOCK MODE, and the control characters used to separate fields and to terminate blocks differ somewhat, depending on the Line/Page Strapping of the terminal and whether or not the terminal is operating in FORMAT MODE. Figure 5-4 illustrates these differences.

In the example in figure 5-5, the user has an application in which order data is to be entered in the same format as a standard company form.

FULL DUPLEX OPERATION

In full duplex operation, the characters which are typed at the keyboard are transmitted to the computer and are not

displayed unless they are returned by the computer. This setting is ignored when in Block Mode.

TELETYPE COMPATIBLE COMMUNICATIONS

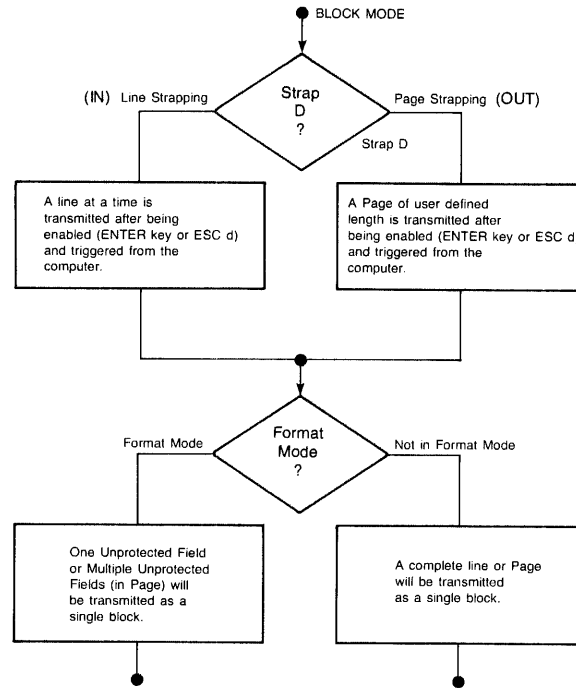
In teletype compatible (full duplex, character mode) applications, the terminal can be quickly configured for use by following the instructions given in the Installation section. Note that if block data transfers are used the computer should be programmed to use the simple DC1/DC2 protocol described under Multicharacter Transfers.

HALF DUPLEX OPERATION (202 MODEM COMPATIBILITY)

In half duplex operation, data is sent in only one direction at a time. In order to change the direction of data flow, a line turn around must occur. This means that the sender becomes the receiver and the receiver becomes the sender. Line turn arounds are controlled by half duplex line protocols. Both the computer and the terminal must use the same protocol otherwise malfunction and loss of data will result. The Main Channel and Reverse Channel protocols are examples of half duplex operation.

Initially the terminal is in the transmit state. While in this state the terminal will ignore data sent from the computer. The terminal will remain in the transmit state until one or more of the following occur:

- An ON to OFF transition on the SB (CCITT 122) line (Reverse Channel)
- An end of data character (ETX or EOT) is sent (Main Channel)



STRAPPED FOR LINE

STRAPPED FOR PAGE

non-FORMAT MODE

- data is transferred from the current cursor position to the end of the line or to a Record Separator (RS) control character, whichever occurs first.
- imbedded control characters are transmitted. If present, the RS character is sent.
- The Block is terminated by the transmission of a CR(LF), a Carriage Return and Line Feed if AUTO LF is depressed. (A local CR(LF) is executed to reposition the cursor; if no more information is present at or beyond the cursor the transmission consists of RS CR(LF)).

- data is transferred from the current cursor position to the end of the terminal's allocated memory or to the next RS, whichever occurs first. Thus the Block to be transferred could be several lines of information.
- imbedded control characters are transmitted. If present, the RS character is sent.
- if multiple lines are in the Block, they are separated by CR LF in the transfer. The Block is terminated by the transmission of an RS.

FORMAT MODE

- only information in Unprotected Fields is transmitted. If the cursor is not in an Unprotected Field it will be forwarded to the next one or RS CR(LF) will be transmitted if no such field exists. Data is transmitted from the cursor position to the end of the Field or an RS, whichever occurs first. Thus the Unprotected Field to be transferred could be longer than one line in length.
- imbedded display control characters are not transmitted. If present, the RS character is sent.
- the Block is terminated by the transmission of a CR(LF) and the cursor is forwarded one character position.

- only information in Unprotected Fields is transmitted. If the cursor is not in an Unprotected Field it will be forwarded to the next one or RS will be transmitted if no such fields exist. Data found in Unprotected Fields is transmitted from the cursor until an RS or the end of memory is encountered.
- imbedded display control characters are not transmitted. If present the RS character is sent.
- a Unit Separator (US) control character (or RS character for multipoint) is transmitted between

Figure 5-4. Block Mode Operation

In the example in figure 5-5, the user has an application in which order data is to be entered in the same format as a standard company form.

STEP 1. The user presses the Special Function key, which he has previously programmed in a remote computer routine to both automatically display the form shown and turn on FORMAT MODE. (REMOTE and BLOCK MODE are depressed.)

STEP 2. All areas of the display have been programmed to be protected except for the dark fields within the form itself. Thus, as data is typed at the keyboard only these dark areas can be written into. The cursor automatically will tab from one field to the next when a field boundary is encountered or by use of the



key. The user now inputs data from the keyboard:

ORDER #	COMPANY NAME	SHIPPING ADDRESS: STREET			
DATE	BILLING #	CITY	STATE	ZIP	
ITEM #	PRODUCT NAME	PRICE	QNTY	TOTAL	CODE

The complete form would look as follows:

ORDER #	COMPANY NAME	SHIPPING ADDRESS: STREET			
DATE	BILLING #	CITY	STATE	ZIP	
ITEM #	PRODUCT NAME	PRICE	QNTY	TOTAL	CODE

STEP 3. After filling out the form and correcting any noticed errors, the key is pressed once. The following sequence of events would then occur:

- Having received a DC1 from the computer, the terminal transmits a DC2.
- Computer software recognizes the DC2 and responds with a second DC1.

- The terminal receives the DC1 and transmits all data as one Block, fields separated by US's and the Block terminated by an RS:

STEP 4. The form full of data has been transmitted to the computer. The user could then Home the cursor, hit , to clear only the data from the form in FORMAT MODE, and enter a second set of data inputs — repeating the sequence and reusing the form.

Figure 5-5. Example of Format Mode with Page Strapping

Data Communications

- The user tries to send an end of data character from the keyboard (control-C, control-D)

The above conditions cause the terminal to switch to the receive state.

The terminal then receives and processes data until one of the following occurs:

- An ON to OFF transition of the CF (CCITT 109) line (Reverse Channel)
- An end of data character (ETX or EOT) is received (Main Channel)

The terminal then requests the computer or modem for permission to transmit. The computer or modem responds with transitions of the CB (CCITT 106) and SB (CCITT

122) lines. (If the computer or modem does not respond within 2.6 seconds the terminal will return to the receive state.) If the computer is ready the terminal will begin to send any data present in its output buffer.

The terminal provides a range of half duplex line protocols, including Bell 202 modem compatible protocols. These protocols are selected by switch settings on the Keyboard Interface PCA. Table 5-8 contains a list of the communication switches that are used to select half-duplex protocols.

Half-duplex operation can be controlled either by RS232C signal lines or by control characters in the data being transferred or by a combination of characters and signals. The Main Channel protocol uses control characters while the Reverse Channel protocol uses control signal lines.

Table 5-8. Keyboard Interface PCA Strapping Options for Point-to-Point

STRAP	STRAPPING OPTION	NORMAL OPERATION (SWITCH CLOSED)	OPERATION WITH STRAPPING OPTION (SWITCH OPEN)
A	Function Key Transmission	The escape code sequence generated by the major function keys (such as, ROLL UP, ROLL DOWN, etc.) are executed locally, but not transmitted to the computer.	The escape code sequences generated by all keys are transmitted to the computer. If operating in half duplex, the function is also executed locally.
B	Space Overwrite (SPOW) Latch Enable	Spaces typed will overwrite existing characters.	When the SPOW latch is off, overwriting occurs as normal. When the SPOW latch is on, spaces cause the cursor to forward but not overwrite any existing characters. The SPOW latch is turned on by a Carriage Return, and off by a Line Feed, Home or Tab.
C	Cursor End-of-Line Wrap Around	At the end of each line, a local Carriage Return and Line Feed are generated; the cursor moves to the beginning of the next line.	A Carriage Return and Line Feed are not generated at the end of each line. The cursor remains in and overwrites column 80.
D	Line/Page	The terminal is set to transfer a line at a time in Block Mode.	Entire pages of information are transferred in Block Mode.
E	Paper Tape Mode	When the <input type="checkbox"/> READ key is pressed with <input type="checkbox"/> AUTO LF key latched down, each tape record begins with an LF and is terminated by a CR.	Each tape record is terminated by CR(LF).
F	Fast Binary Read	The transmission rate is determined by the BAUD RATE switch on the keyboard.	When an ESC e (Fast Binary Read) is issued by the computer, the baud rate is switched automatically to 9600 baud (if the terminal is equipped with cartridge tape units).

Table 5-8. Keyboard Interface PCA Strapping Options for Point-to-Point (Continued)



STRAP	STRAPPING OPTION	NORMAL OPERATION (SWITCH CLOSED)	OPERATION WITH STRAPPING OPTION (SWITCH OPEN)
G	Block Transfer Handshake	In Block Mode, all data transfers to the computer are sent upon receipt of a DC1 from the computer.	All Block Mode transfers (i.e., cursor sense, terminal and device status, device I/O responses, display memory, and function keys) are preceded by a DC2. The terminal sends the DC2 upon receipt of a DC1 from the computer. After the CPU receives the DC2 from the terminal, another DC1 is required to trigger transmission of data from the terminal.
H	Inhibit DC2	During Block Mode Handshake transfers, the terminal sends a DC2 in response to a DC1 prior to sending data. (See Block Transfer Handshake strapping above.)	A DC1 from the computer is not required to trigger data transfers to the computer. Also, the DC2 from the terminal is not sent during Block Mode Transfer handshakes. (See Block Transfer Handshake strapping above.) Additionally, when the  key is pressed in Block Mode the cursor will be placed in the first column before transmission occurs if operating in Line/Field Mode (switch D closed) or Home'd if operating in Page Mode (switch D open.) Opening both switches G and H eliminate the terminal's use of the Handshake protocol entirely.
J	Auto Terminate	No effect.	When in BLOCK mode and the ENTER key is pressed, places a non-displaying terminator before the cursor position.
K	Clear Terminator	No effect.	Clear terminator caused by Strapping Option J or ESC -.
L	Self Test Inhibit	No effect.	Self Test function is inhibited. Pressing TEST key or issuing ESC z displays the NO TEST message. TAPE TEST and DATA COMM SELF TEST functions are not affected.
M	INSERT and DELETE CHAR with wrap (Reverse Sense)	No effect.	Reverses effect of  key on INSERT CHAR and DELETE CHAR keys (i.e., when key is pressed, line wrap around is in effect without having to press CNTL key. When either key is pressed while pressing CNTL, normal insert character and delete character functions are in effect.)
N	Escape Code Transfer to Printer.	No effect.	Escape codes relating to the display (e.g., display enhancements, alternate character sets, format mode, fields, etc.) are sent to printer if it is selected as a destination device.

Table 5-8. Keyboard Interface PCA Strapping Options for Point-to-Point (Continued)

STRAP	STRAPPING OPTION	NORMAL OPERATION (SWITCH CLOSED)	OPERATION WITH STRAPPING OPTION (SWITCH OPEN)
P,Q	(Not used)		
R	Circuit Assurance	The transition from receive state to transmit state occurs after both CB (106) (Clear to Send) and SB (122) (Secondary Receive Data) go on within 2.6 seconds. Otherwise, the terminal returns to the receive state.	The transition from receive state to transmit state occurs after CB (106) (Clear to Send) goes on.
S,T	Main Channel Protocol	Reverse Channel protocol (both switches closed).	S-closed, T-open: Main channel with STX/ETX as Start of Data and End of Data. S-open, T-closed: Main channel with EOT as End of Data. S-open, T-open: Main channel with ETX as End of Data.
U	CPU Break	The CPU can interrupt the terminal while it is in the transmit state. The CPU initiates an ON to OFF transition of the SB (122) (Secondary Receive Data) line. The terminal responds by turning off CA (106) (Request to Send) and going to the receive state.	The terminal ignores all transitions on the SB (122) (Secondary Receive Data) line from the modem in the transmit state.
V	Carrier Detect	When the terminal is in the receive state, an ON to OFF transition of CF (109) (Carrier Detect) line from the modem causes the terminal to go into the transmit state. Transitions of CF have no effect while the terminal is in the transmit state.	Transitions of CF (109) (Carrier Detect) line have no effect on the terminal.
W	Data Comm Self Test Enable	Enables DATA COMM SELF TEST from either the keyboard or escape sequence.	Disables DATA COMM SELF TEST. If self test is attempted (by either the keyboard or escape sequence), the test will be aborted and ERROR 0 will appear on the display.
X	Data Speed Select	Holds data speed signal low (CH (111) = 0).	Sets data speed signal high (CH (111) = 1).
Y	Transmit LED	The TRANSMIT light on the keyboard is turned on when CB (106) (Clear to Send) line from the modem is high. It is turned off when the CB (106) line goes low.	The TRANSMIT light on the keyboard is turned on when the CC (107) (Data Set Ready) line from the modem is high and the 13260B Extended Asynchronous Communications Interface PCA is used. It is turned off when the CC line goes low.
Z	Parity	The PARITY switch on the terminal keyboard is affected as follows:	
		No Parity: Send 8 bits and receive 8 bits. Force bit 8 to zero. Check for parity error. Odd Parity: Send 7 data bits + odd parity. Receive 7 data bits + odd parity. Check for parity error. Even Parity: Send 7 data bits + even parity. Receive 7 data bits + even parity. Check for parity error.	No Parity: Send 8 bits and receive 8 bits. Force bit 8 to one on send. No check for parity error. Odd Parity: Send 7 bits + odd parity. Receive 7 bits. No check for parity error. Even Parity: Send 7 data bits + even parity. Receive 7 data bits. No check for parity error.

MAIN CHANNEL (CHARACTER CONTROL) PROTOCOL. The Main Channel protocol is for use in half-duplex or Bell 202 modem equivalent networks where secondary channel signals are not available. The Main Channel protocol uses control characters to "frame" each data transmission. These framing characters indicate to the receiving station that a data transmission has begun or ended.

An ASCII STX (octal 002) character can be used to indicate the start of a data transmission. An ASCII ETX (octal 003) or EOT (octal 004) character is used to indicate the end of a data transmission. When these characters are received they are used to perform a line turn-around.

The following switch settings should be made on the Keyboard Interface PCA to operate using the Main Channel protocol:

SWITCH	SETTING	DESCRIPTION
R	Open	
S,T	Closed, Open Open, Closed Open, Open	<STX> data <ETX> data <EOT> data <ETX>

Note that at least one of the S or T switches must be open to select Main Channel protocol.

Example:

U,V,W,X,Y,Z All Open — Variations of the Main Channel Protocol are discussed under Other Protocols and in Appendix C.

The operation of the Main Channel protocol is shown in figure 5-6. Sample data transfers are shown in figure 5-7. Figures 5-7a and 5-7b illustrate the line turn-arounds that occur during a log-on sequence when in character mode. Figures 5-7c and 5-7d illustrate the transfers that occur during block mode operation.

REVERSE CHANNEL (SIGNAL LINE CONTROL) PROTOCOL. The Reverse Channel protocol is for use in half-duplex or Bell 202 modem equivalent networks where secondary channel signals are available. The Reverse Channel protocol uses changes on secondary channel lines SA (CCITT 120) and SB (CCITT 122) to control line turn-arounds.

The following settings should be made on the Keyboard Interface PCA to operate using the Reverse Channel protocol.

SWITCH	SETTING	DESCRIPTION
R	Closed	Monitor the CB line
S,T	Closed, Closed	Reverse Channel (no framing characters)
U	Closed	Watch for computer interrupts (SB>0)
V	Closed	Watch for Carrier (CF) transitions

Example:

W,X,Y,Z All Open — Variations of the Reverse Channel protocol are discussed under Other Protocols and in Appendix C.

The operation of the Reverse Channel protocol is shown in figure 5-8. Sample data transfers are shown in figure 5-9.

OTHER PROTOCOLS. In addition to the Main and Reverse Channel protocols you can select various features of both to configure a custom protocol to suit your own requirements. A flowchart of the overall Basic Communications function including the Half-Duplex settings is given in Appendix C. You can create a custom protocol using this flowchart and the switch descriptions in table 5-8. When more than one terminal must share a modem or hardwired communication line, the Multipoint protocol must be used. Refer to the description of Block Protocols.

MONITOR MODE

Monitor Mode is an added feature available with the 13260A and 13260B interfaces. Refer to Multipoint Monitor Mode for a description.

CONFIGURATION

A procedure for configuring the terminal for point-to-point operation is given in figure 5-10.

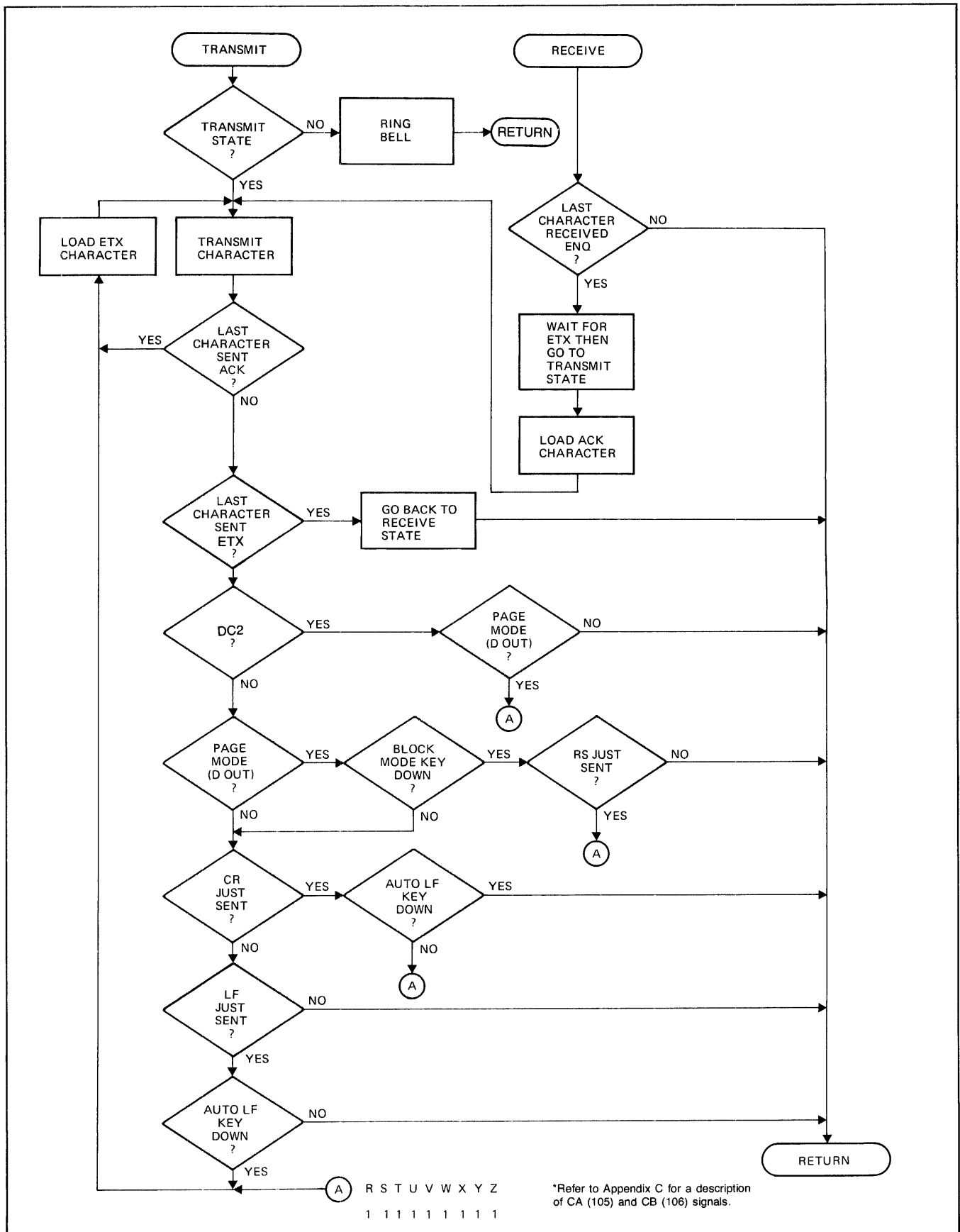


Figure 5-6. Main Channel Protocol

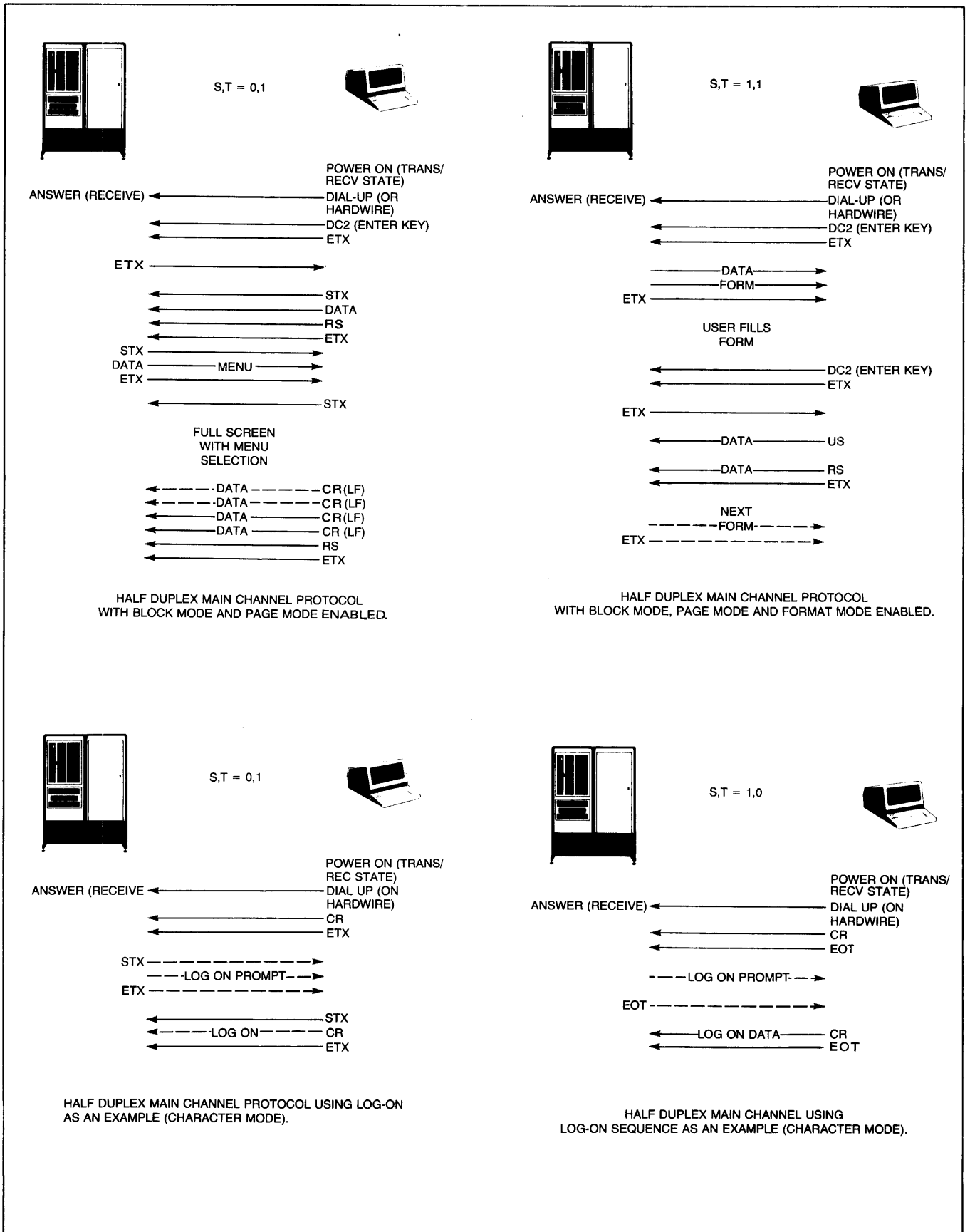


Figure 5-7. Sample Data Transfers Using Main Channel Protocol

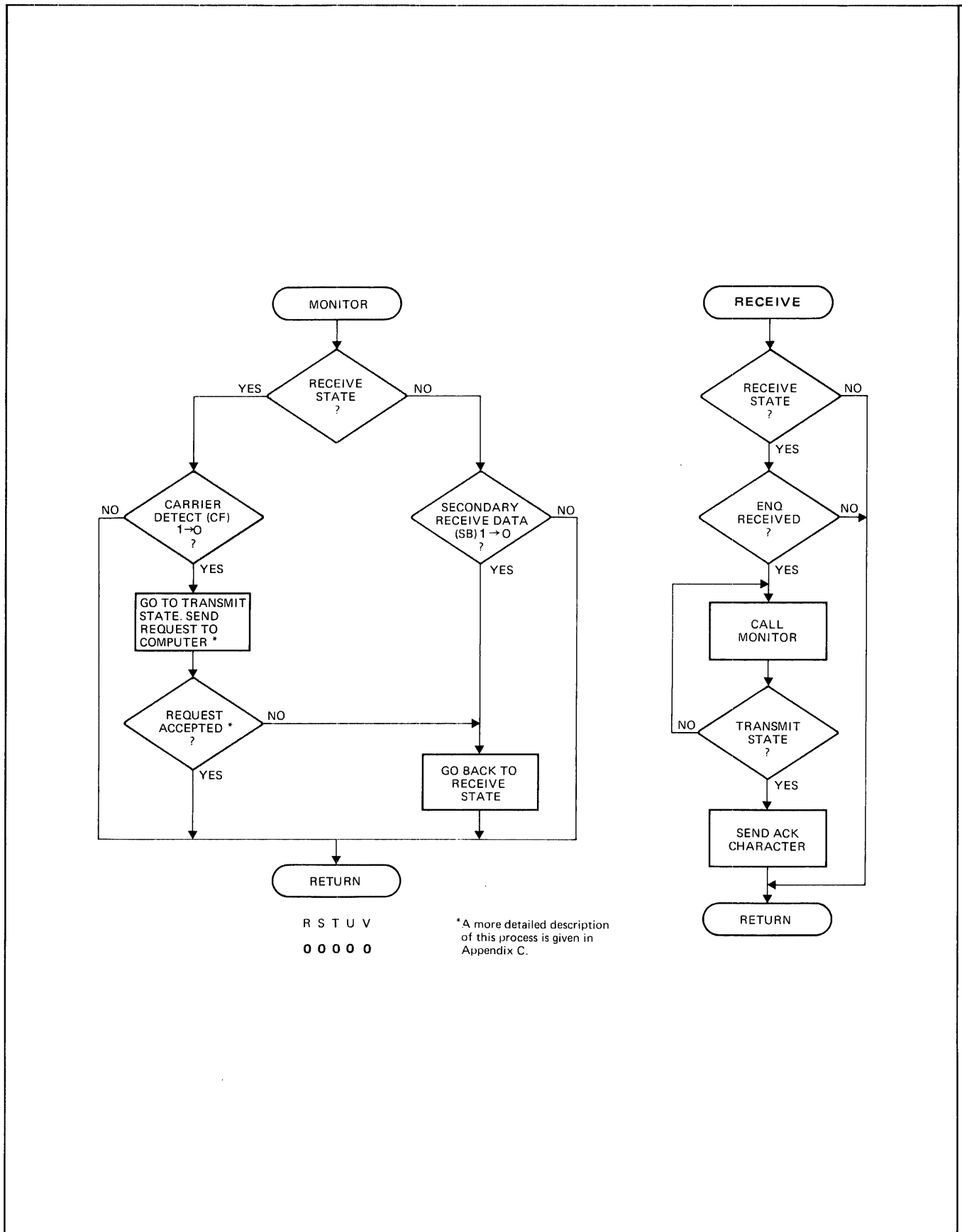


Figure 5-8. Reverse Channel Protocol

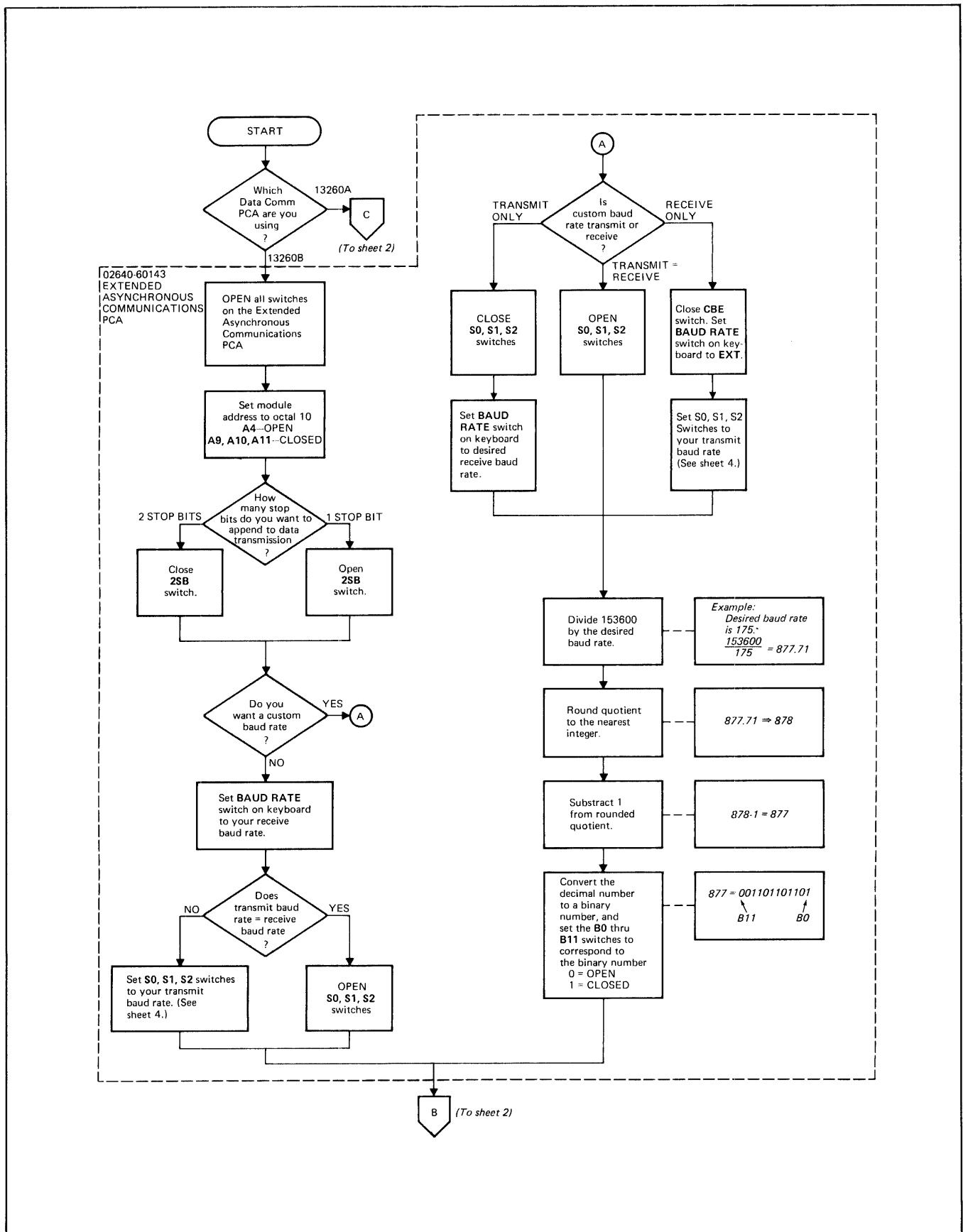


Figure 5-10. Point-to-Point Data Communications Configuration Flowchart (Sheet 1 of 4)

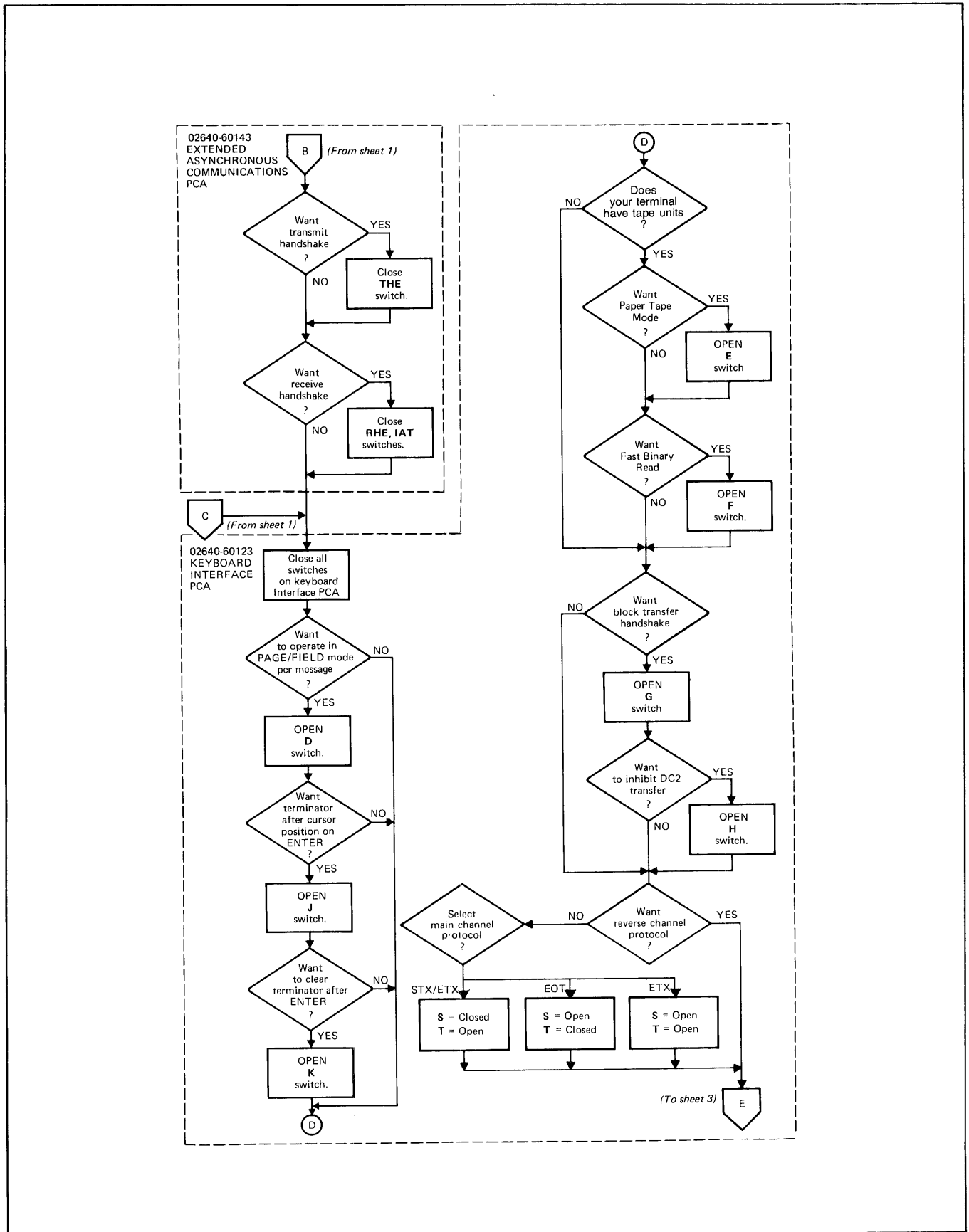


Figure 5-10. Point-to-Point Data Communications Configuration Flowchart (Sheet 2 of 4)

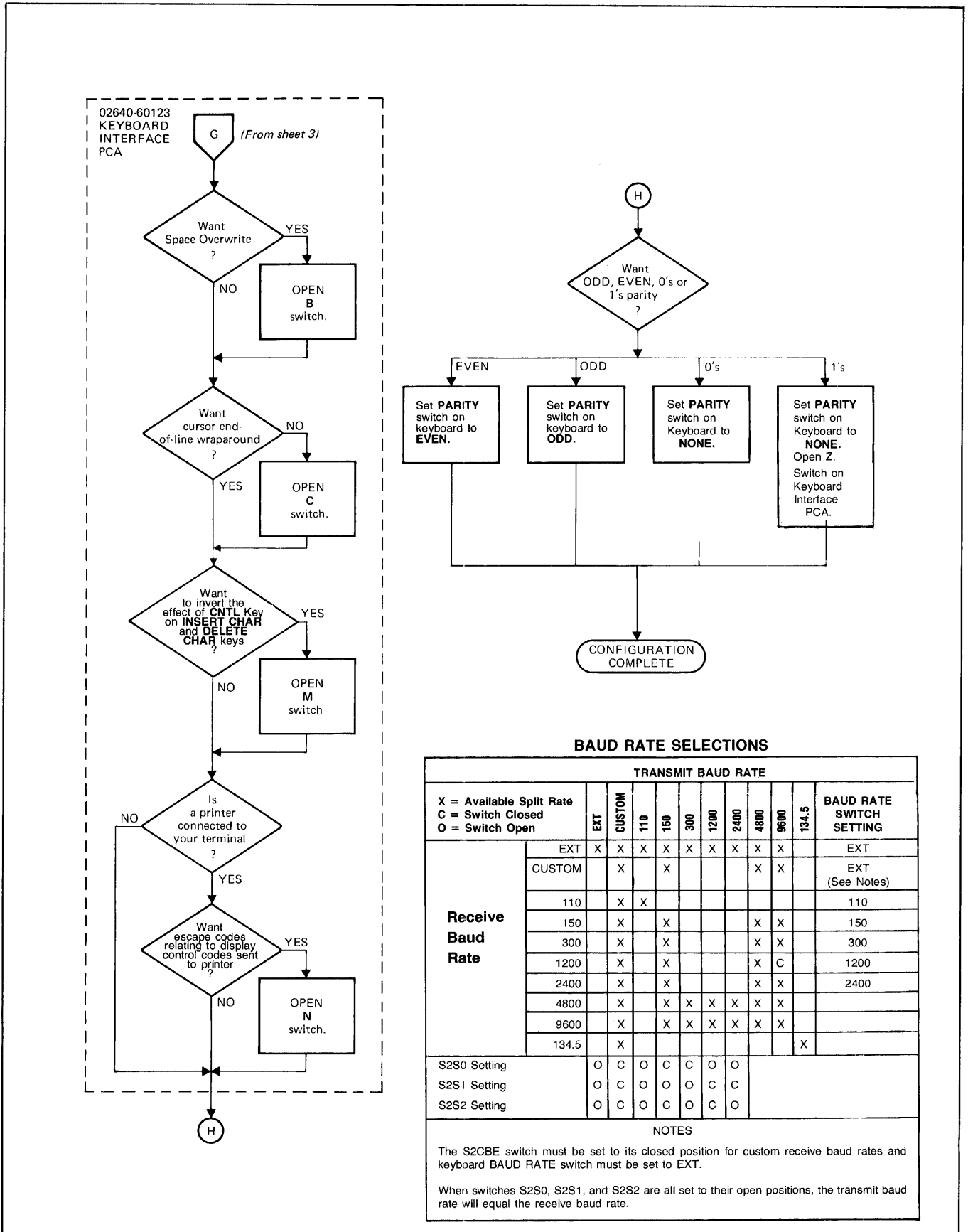


Figure 5-10. Point-to-Point Data Communications Configuration Flowchart (Sheet 4 of 4)

BLOCK PROTOCOLS WITH 13260C OR 13260D COMMUNICATIONS ACCESSORY

Block protocols transfer data in blocks. The blocks are made up of three parts:

- Block framing characters
- Text (1 to n characters, where n depends on terminal configuration).
- Block check character(s)

This data format is always present in block protocols. In addition, block protocols use special character sequences to control all data transfers.

A block check character is included at the end of each data block. If a data error is detected the protocol will normally automatically attempt a retransmission of the block.

CHARACTER MODE TRANSFERS

Character mode transfers are not permitted with block protocols. All data transfers are implemented using a block data structure.

MULTI CHARACTER TRANSFERS

When the terminal makes a multi character response of fixed length to the computer (status etc.), the data sent will be in the form of a block with framing characters and one or two block check characters.

MESSAGE BLOCKS

A message consists of one or more blocks of text data. The use of blocks enables the terminal to efficiently buffer data, respond to transmission errors and guarantee data integrity. Maximum block size is strap selectable and permits you to use the size best suited to computer requirements. (Refer to Buffer Size.)

BLOCK OPERATION

The block protocol is designed to operate using either synchronous or asynchronous communications. Data transmission is done in multiple character blocks. The block size used is limited by the terminal's communications buffer (refer to Configuration).

NOTE

Operating at data rates of 4800 baud or greater can result in a loss of data if the terminal input buffer is not large enough. If this happens an EOT character will be sent to the computer. At data rates of 4800 baud or greater the size of the data block sent from the computer should not exceed twice the size of the terminal input buffer. For example, an input buffer size of 1024 bytes would be required to accept a 2048 byte block from the computer (a full page of data).

Two forms of text blocks are shown in figure 5-11. The first is a block received from a computer. Note that no id characters are used since the terminal or terminals to receive the data have already been identified by a select sequence. The second block is one sent from a terminal. In multipoint configurations, since more than one terminal may have been polled, the first text block sent from each terminal must have the terminal id included. The id characters are not repeated (as in poll and select sequences) since they are included in the block check character.

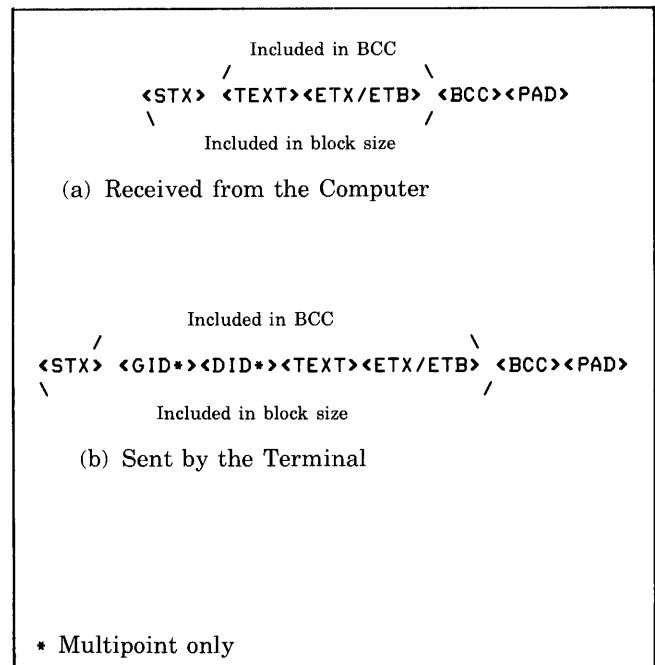


Figure 5-11. Examples of Block Transmissions

DATA CHECKING. There are two types of data checking used with the multipoint protocol. The first is a check of each character as it is received and is called a vertical redundancy check (VRC). This check is only used for ASCII coded characters. The second is a check of an entire block of data and is called a block check. Two types of block check are available. The first is a longitudinal redundancy check (LRC). You can also choose a more complex block check called a cyclic redundancy check (CRC).

Character Checking. The vertical redundancy check is also known as a parity check. When an ASCII character is transmitted by the computer or the terminal, the high order (eighth bit of each character is set to a "1" or a "0" to make the number of "1" bits in the character either even (EVEN parity) or odd (ODD parity). In addition you can select settings that will force the parity bit to "0" or "1". At the time the terminal is configured for use, either even, odd, none, "0", or "1" parity is selected. The parity must be the same for both the computer and the terminal. For example, if even parity is used the high order bit of each character would be set to cause the number of "1" bits in the character to be even.

Character checking is not done when EBCDIC code is used or when operating in transparency mode. The parities available are listed in table 5-9.

Table 5-9. Parities Available with ASCII Data

FORCED PARITY JUMPER SET TO "0" (STRAP Z CLOSED)	
ODD PARITY	Input characters are checked for odd parity. Output characters are supplied with odd parity.
EVEN PARITY	Input characters are checked for even parity. Output characters are supplied with even parity.
NONE PARITY	Input characters are checked for a "0" parity bit. Output characters are supplied with a "0" bit for parity.
FORCED PARITY JUMPER SET TO "1" (STRAP Z OPEN)	
ODD PARITY	Input characters are checked for odd parity. Output characters are supplied with odd parity.
EVEN PARITY	Input characters are checked for even parity. Output characters are supplied with even parity.
NONE PARITY	Input characters are checked for a "1" parity bit. Output characters are supplied with a "1" bit for parity.

Block Checking. Each block includes a block check character (BCC). The BCC character(s) is in addition to the parity bit set for each character transmitted. This BCC can be a one (LRC) or a two (CRC16) character check sum. The type of BCC and parity desired can be set to match almost any communications requirements.

LRC. The LRC check character is a 7 bit check sum obtained by exclusive "OR"ing the low order 7 bits of each character included in the text block. A parity bit (VRC) is then added to this character when it is transmitted. For EBCDIC, all 8 bits are "OR'ed" together and no parity bit is added.

CRC16. The CRC16 check is a 16 bit (two character) check sum calculated using the following formula:

$$X^{16} + X^{15} + X^2 + 1$$

This is compatible with the CRC16 check sum used by IBM.

STRAP SELECTABLE OPTIONS. The following options are strap selectable on the interfaces used by the block protocols:

- Code Selection (ASCII/EBCDIC)
- Block Check Character (LRC/CRC16)
- Data Comm Buffer Size
- Block Input Mode

Code Selection (ASCII/EBCDIC). The terminal can be set to use either ASCII or EBCDIC data codes. All data and most control characters translate directly from one code to the other (map to the same graphic). A list of the characters and their codes is given in Appendix C. Control characters that do not translate directly between the two codes are:

ASCII		
graphic		octal
ACK0	DLE 0	020 060
ACK1	DLE 1	020 061
WACK	DLE ;	020 073
RVI	DLE <	020 074
EBCDIC		
graphic		octal
ACK0	DLE (no graphic	020 160
ACK1	DLE / equivalent)	020 141
WACK	DLE ,	020 153
RVI	DLE @	020 174

All terminals on the same communication line must use the same code type.

Data Communications

The J07 switch is used to select the code to be used to represent data. The codes available are as follows:

J07	
0	(closed) = ASCII
1	(open) = EBCDIC

Block Check Character (BCC). The Block Check Character is used to verify the accuracy of transmitted data. Switch J06 allows you to select the type of test used. The terminal will then automatically perform the proper test and generate the same type of check character sent to the computer. The types of check character available are as follows:

J06	
0	(closed) = Longitudinal redundancy check (VRC/LRC)
1	(open) = Cyclic Redundancy Check (CRC 16)

Buffer Size. You must set the amount of terminal memory allocated for use as input and output communication buffers. When the terminal is inputting data it uses this space for a single input buffer. When the terminal is outputting data the buffer space is divided into two or more output buffers. The basic terminal configuration uses a 512 byte input buffer or two 256 byte output buffers.

It is often desirable to increase the size of the communication buffers to optimize use of the computer. The size of the terminal's input buffer can be set on the communication interface. The input buffer size can range from 512 to 4K bytes.

Memory is allocated from the terminal's display memory so that the larger the buffer size, the smaller the amount available to display memory.

Input buffer size is set by switches J17 and J16 as follows:

J17	J16	Input Buffer	
0	0	= 512 bytes	where 1 = open
0	1	= 1024 bytes	0 = closed
1	0	= 2048 bytes	
1	1	= 4096 bytes	

Output buffer size can range from 256 to 2K bytes. Output buffer sizes are limited to a maximum of one half the input buffer size. Output buffer sizes are set with switches T and U on the Keyboard Interface as follows:

T	U	
0	0	2 buffers, each one half the size of the input buffer (2k max)
1	0	256 bytes
0	1	512 bytes
1	1	1024 bytes

where: 1 = open
0 = closed

Note that if the output buffer is inadvertently set larger than one half of the input buffer size the terminal will default to the 0,0 setting of the T and U switches.

Block Check Mode. Switch J15 is used to select the way the terminal will process data blocks received from the computer. The switch settings are as follows:

J15		
1	(open)	= An entire block of text is held until the block check character (BCC) is received and the text block is verified as correct. The text data is then processed by the terminal.
0	(closed)	= Each character in a block of text is processed as it is received, without waiting for receipt of the Block Check Character (BCC).

TRANSPARENCY MODE (BINARY OPERATION). Transparency mode allows you to send and receive 8 bit binary data. This allows the sending of data bit patterns that might otherwise be interpreted as control characters.

This mode is controlled with the following character sequences:

DLE STX Start transparency.

DLE ETX Ends transparency.

or
DLE ETB

DLE DLE Allows one DLE character to be sent. Note that this will vary with the parity used.

- DLE SYN Allows one SYN character to be sent (for synchronous operation). Not included in text or BCC.
- DLE ENQ Aborts current transmission.

Note that whenever control character sequences are used in transparent mode they must have proper parity or they will not be interpreted as control characters. If ASCII code is used, then the parity must be specified as "none", "forced", or CRC16 must be selected.

Once in transparency mode, in order to send control characters and have them interpreted as control characters rather than binary data, the control character must be preceded with a single DLE character. Single DLE characters are seen as the beginning of control sequences rather than data. The first DLE character of the above sequences is never included in the block check.

BLOCK PROTOCOL CONTROL SEQUENCES

Block protocols require specific control sequences to acknowledge text block transfers, terminate text transfers or to inform the sender or receiver of status changes. S. These sequences consist of one or more data link control characters. A list of these control characters are given in table 5-10. A summary of the uses of these characters is given in table 5-11.

Transparency requires one of the following settings:

- CRC16
- Strap Z open
- EBCDIC code
- NONE selected on Parity Switch

Figure 5-12 illustrates the operation of the various control characters used in the block protocol.

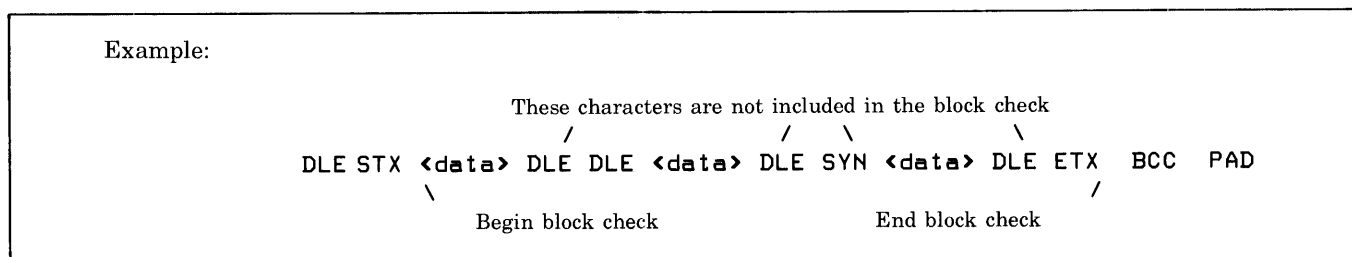


Table 5-10. Block Protocol Control Characters

CONTROL CHARACTER	ASCII CODE (OCTAL)	DESCRIPTION
Data link control characters. These characters are used to frame messages and acknowledgements for both transmitted and received text blocks. They are also used to control all communications in an orderly fashion.		
DLE	020	Data Link Escape. This is the first character in two byte control characters. It is used to indicate that the second character is to be interpreted as a control rather than a data character. The DLE character has no meaning when used alone.
ACK0 (DLE 0)	020 060	Acknowledge 0. These control characters are sent by the terminal after being selected to tell the computer that the terminal is ready to accept a text block. They are also sent by the receiving station (computer or terminal) after even text blocks (2, 4, etc.) to tell the sending station (terminal or computer) that the block was received properly (see ACK 1).
ACK1 (DLE 1)	020 061	Acknowledge 1. These control characters are sent by the receiving station (computer or terminal) after odd text blocks (1, 3, 5, etc.) to tell the sending station (terminal or computer) that the block was received properly (see ACK 0).

Table 5-10. Block Protocol Control Characters (Continued)

CONTROL CHARACTER	ASCII CODE (OCTAL)	DESCRIPTION
WACK (DLE ;)	020 073	Wait Before Transmit. These characters are sent by the receiving station to indicate that the last block was properly received but that the receiving station requests that the sender wait before sending the next block. The sending station should then send an ENQ. The receiving station will then return an ACK 0 if it is ready to receive data or a WACK in order to continue waiting.
NAK	025	Negative Acknowledge. This character is used by the terminal to respond to a select sequence to tell the computer that it is not ready to receive text blocks at that time. This character can also be returned in response to a text block to indicate that the block was rejected because of a bad block check or because of improper framing characters. When received by the terminal after it has sent a text block, the terminal will retransmit the block.
ENQ	005	Enquiry. This character is always used as to terminate a POLL or SELECT sequence. It is also used by the sending station to request a retransmission of the acknowledgement for the previous text block.
STX	002	Start of Text. This character must be the first character in every text block. It tells the receiving station to begin accumulating a block check character. The STX character is not included in the block check.
ETB	027	End of Transmission Block. This character is used to tell the receiving station to stop accumulating a block check character and that the next character transmitted will be the block check character. When used the ETB character must always follow the last character in the text block. The ETB character is included in the block check character accumulation. (See the ETX character.)
ETX	003	End of Text. This character must be the last character of the last (or only) text block in a message. It tells the receiving station to stop accumulating a block check character. The ETX character is included in the block check character. (See the ETB character.)
EOT	004	End of Transmission. When this character is sent or received by the terminal, it causes the terminal to switch to Control Mode. It is sent by the terminal when it detects a data overflow condition while receiving text (buffer full), after sending the last text block of a message to the computer, or in response to a POLL sequence when it has no data to send. An EOT is sent by the computer following the last text block in a message to indicate that the computer has no more data to send or when the computer wants to abort the communication sequence.
RVI (DLE <)	020 074	Reverse Interrupt. This character is sent by the computer to acknowledge that the last text block was properly received (see ACK0 and ACK1) and at the same time to request that the terminal stop sending as soon as possible. When this character is received by the terminal, the terminal will immediately send an EOT to the computer.
Transmission control characters. These characters are used to initialize, synchronize, and terminate data without affecting data integrity.		
SYN	026	Synchronous Idle. This character is used only in synchronous communications to establish and maintain character timing between sending and receiving stations. At the beginning of each transmission a minimum of three SYN characters are required. During transmission two pair of SYN characters are inserted at one second intervals.
PAD (trailing)	177 + parity	Trailing PAD. This character is used to ensure that the last character of every transmission has time to be properly received before the receiving station begins transmitting. All transmissions must be terminated with a trailing PAD. In addition a trailing PAD must always be used after an EOT when it is used in a POLL or SELECT sequence. (Note that accuracy of the PAD character cannot be guaranteed.)
DLE EOT	020 004	Disconnect. When this sequence is received by the terminal instead of a normal response or text block, the terminal will attempt to disconnect the modem attached to the communication line.

Table 5-11. Summary of Block Protocol Control Characters

	CONTROL		TEXT-IN		TEXT-OUT	
	POLL RESPONSE	SELECT RESPONSE	RECEIVED	TRANSMITTED	RECEIVED	TRANSMITTED
STX-"TEXT"-ETB-ETX	Positive response to POLL.		Sent by CPU as a response to an ACK received from terminal.			Sent by terminal as a response to an ACK received from CPU.
"EOT"	Negative response to POLL. Terminal has no TEXT to xmit.		CPU has no more TEXT to xmit to terminal.	Terminal has detected data overflow.	CPU has decided to abort terminal xmission.	Term has no more TEXT to send to CPU or has just received an "RVI".
"ENQ"			CPU requests terminal send last TEXT acknowledgement.			Term requests CPU retransmit last acknowledgement to TEXT.
"RVI"					CPU acknowledges last TEXT block & requests term send "EOT".	
"ACK0/ACK1"		Terminal tells CPU that it is ready to accept TEXT (ACK0).		Terminal tells CPU that last TEXT block was received OK.	CPU tells term that last TEXT that term sent was OK.	
"WACK"		Term is temporarily busy (term has no available buffers). Cannot accept TEXT.		Term acknowledges last TEXT block received.OK but now term has no more buffers & cannot accept more TEXT.	CPU acknowledges last TEXT block sent by term but tell term to wait because CPU does not have any more buffs.	
"NAK"				Term detected error in last TEXT block CPU sent. Invalid VRC/BCC or frame chars.	CPU detected error in last TEXT block term sent. Invalid VRC/BCC or frame chars.	

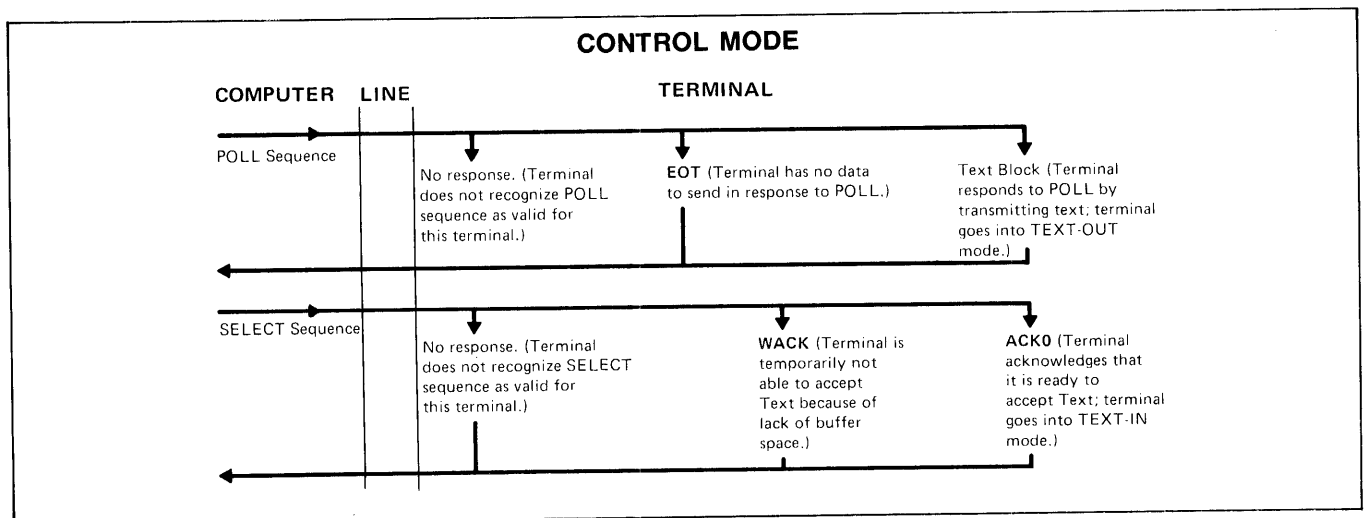


Figure 5-12. Operation of Block Protocol Control Characters (Sheet 1 of 2)

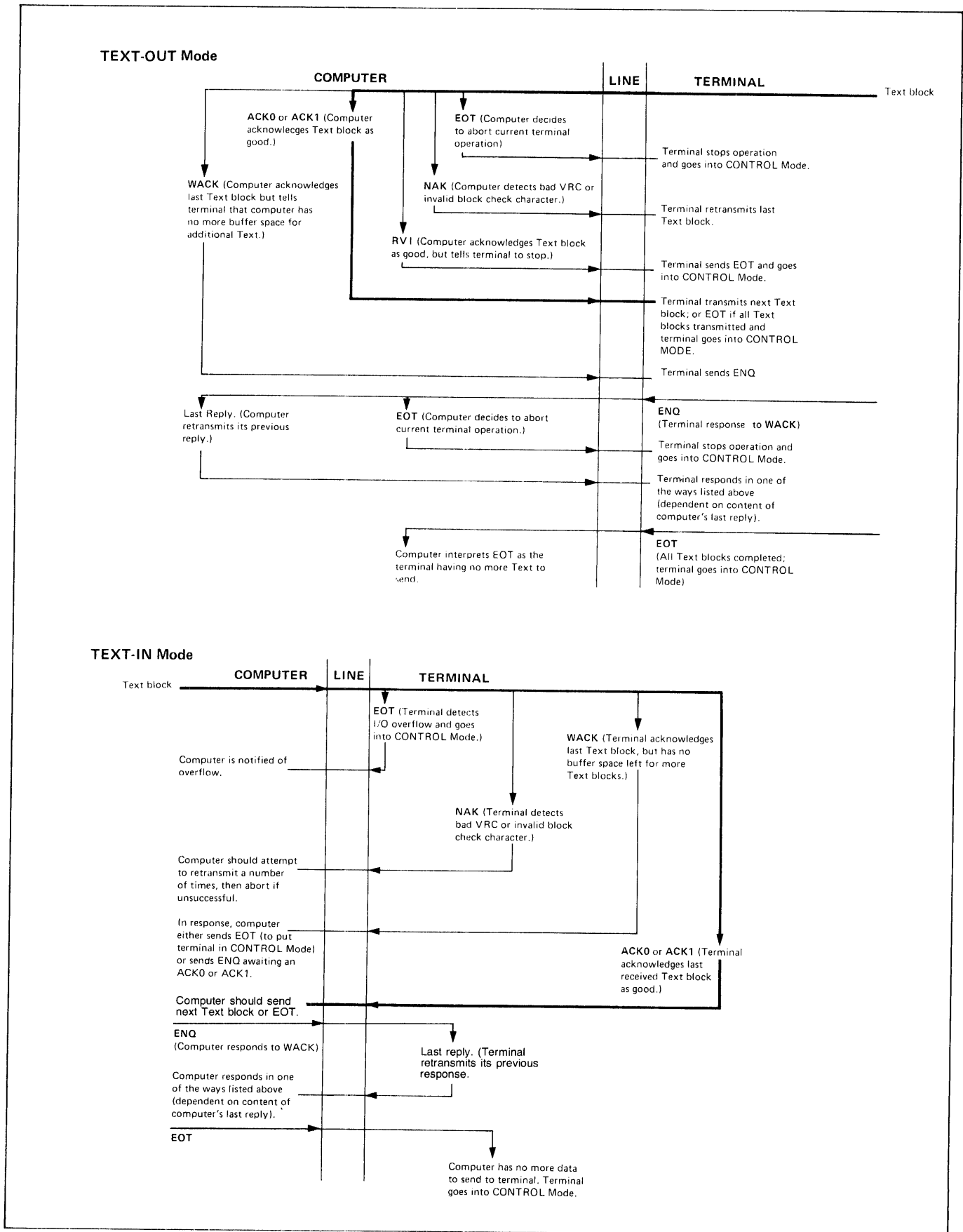


Figure 5-12. Operation of Block Protocol Control Characters (Sheet 2 of 2)

KEYBOARD INTERFACE STRAPS. The Keyboard Interface straps permit you to select various communication features. A list of the selectable features is given in table 5-12.

Table 5-12. Keyboard Interface Straps for Block Operation Using 13260C or 13260D Communications Accessory

STRAP	STRAPPING OPTION	NORMAL OPERATION (SWITCH CLOSED)	OPERATION WITH STRAPPING OPTION (SWITCH OPEN)
A	Function Key Transmission	The escape code sequence generated by the major function keys (such as, ROLL UP, ROLL DOWN, etc.) are executed locally, but not transmitted to the computer.	(Same as switch closed.)
B	Space Overwrite (SPOW) Latch Enable	Spaces typed will overwrite existing characters.	When the SPOW latch is off, overwriting occurs as normal. When the SPOW latch is on, spaces cause the cursor to forward but not overwrite any existing characters. The SPOW latch is turned on by a Carriage Return, and turned off by a Line Feed, Home, or Tab.
C	Cursor End-of-Line Wrap Around	At the end of each line, a local Carriage Return and Line Feed are generated; the cursor moves to the beginning of the next line.	A Carriage Return and Line Feed are not generated at the end of each line. The cursor remains in and overwrites column 80.
D	Line/Page	The 2645 is set to transfer a line at a time from display memory, an unprotected field in format mode, or a record from the tape cartridge.	Transfers the entire contents of display memory (a "page"), all unprotected fields in format mode, or a file from the tape cartridge.
E	Paper Tape Mode	When the READ key is pressed with the AUTO LF down, each tape record begins with an LF if the AUTO LF key is down and is ended with a CR.	Each tape record is terminated by CR(LF).
F	(Not Used)		
G	Block Transfer Handshake	No effect.	No effect.
H	Inhibit DC2	No effect.	No effect.
J	Auto Terminate	No effect.	When the ENTER key is pressed a non-displaying terminator is placed after cursor position.
K	Clear Terminator	No effect.	Clear terminator caused by strapping option J above.
L	Self Test Inhibit	No effect.	Self Test function is inhibited. Pressing TEST key or issuing ESC z has no effect. TAPE TEST and DATA COMM SELF TEST functions are not affected.
M	Reverse Sense of INSERT and DELETE CHAR with Wrap.	No effect.	Reverses control function of INSERT CHAR and DELETE CHAR keys (i.e., when key is pressed, line wrap around is in effect without having to press CNTL key. When either key is pressed while pressing CNTL, normal insert character and delete character functions are in effect.)
N	Escape Code Transfer To Printer	No effect.	Escape codes relating to the display (e.g., display enhancements, alternate character sets, format mode, fields, etc.) are sent to printer if it is selected as a destination device.
P	(Not Used)		
R	Set Trailing Pad	If in ASCII mode (switch J07 closed on multipoint PCA), sets pad to 177 (octal) + parity. If in EBCDIC mode (switch J07 open on multipoint PCA), sets pad to 377 (octal).	Sets pad to 377 (octal) if any of the following conditions are present: (1) PARITY switch on keyboard is set to NONE. (2) Switch Z on this PCA is open. (3) CRC-16 is selected (switch J06 on multipoint PCA is closed).

Table 5-12. Keyboard Interface Straps for Block Operation Using 13260C or 13260D Communications Accessory (Continued)

STRAP	STRAPPING OPTION	NORMAL OPERATION (SWITCH CLOSED)		OPERATION WITH STRAPPING OPTION (SWITCH OPEN)		
S	(Not Used)					
T,U	Output Block Size	T	U	BLOCK SIZE (BYTES) 1/2 Data Comm Buffer (refer to switches J16, J17 on multipoint PCA). 256 512 1024		
		C	C			
		O	C			
		C	O			
		O	O			
		C = closed, O = open				
V	Continuous Carrier	Continuous carrier off indicates that the modem does not have continuous carrier.		Continuous carrier on indicates that the modem does have continuous carrier. Allows firmware to abort operation.		
W	Data Comm Self Test	Enables DATA COMM SELF TEST from either the keyboard or escape sequence.		Disables DATA COMM SELF TEST. If self test is attempted (by either the keyboard or escape sequence), the test will be aborted and ERROR 0 will appear on the display.		
X	Data Speed Select	Holds data speed signal low (CH = off).		Sets data speed signal high (CH = on).		
Y	Transmit Indicator	Lights TRANSMIT indicator on keyboard when terminal is communicating with the computer.		Lights TRANSMIT indicator on keyboard when Data Set Ready (CC) is on, and it goes out when CC goes off.		
Z	Parity	<p>The PARITY switch on the terminal keyboard is affected as follows:</p> <table border="0"> <tr> <td> <p>No Parity: Send 8 bits and receive 8 bits. Force bit 8 to zero. Check for parity error.</p> <p>Odd Parity: Send 7 data bits + odd parity. Receive 7 data bits + odd parity. Check for parity error.</p> <p>Even Parity: Send 7 data bits + even parity. Receive 7 data bits + even parity. Check for parity error.</p> </td> <td> <p>No Parity: Send 8 bits and receive 8 bits. Force bit 8 to one. Check for parity error.</p> <p>Odd Parity: Send 7 bits + odd parity. Receive 7 bits + odd parity. Check for parity error.</p> <p>Even Parity: Send 7 data bits + even parity. Receive 7 data bits + even parity. Check for parity error.</p> </td> </tr> </table>			<p>No Parity: Send 8 bits and receive 8 bits. Force bit 8 to zero. Check for parity error.</p> <p>Odd Parity: Send 7 data bits + odd parity. Receive 7 data bits + odd parity. Check for parity error.</p> <p>Even Parity: Send 7 data bits + even parity. Receive 7 data bits + even parity. Check for parity error.</p>	<p>No Parity: Send 8 bits and receive 8 bits. Force bit 8 to one. Check for parity error.</p> <p>Odd Parity: Send 7 bits + odd parity. Receive 7 bits + odd parity. Check for parity error.</p> <p>Even Parity: Send 7 data bits + even parity. Receive 7 data bits + even parity. Check for parity error.</p>
<p>No Parity: Send 8 bits and receive 8 bits. Force bit 8 to zero. Check for parity error.</p> <p>Odd Parity: Send 7 data bits + odd parity. Receive 7 data bits + odd parity. Check for parity error.</p> <p>Even Parity: Send 7 data bits + even parity. Receive 7 data bits + even parity. Check for parity error.</p>	<p>No Parity: Send 8 bits and receive 8 bits. Force bit 8 to one. Check for parity error.</p> <p>Odd Parity: Send 7 bits + odd parity. Receive 7 bits + odd parity. Check for parity error.</p> <p>Even Parity: Send 7 data bits + even parity. Receive 7 data bits + even parity. Check for parity error.</p>					

KEYBOARD DATA COMM SWITCHES. The keyboard data comm switches are shown in figure 5-13.

Parity Switch. This switch is used only with ASCII code and is ignored when EBCDIC code is used. The settings are as follows:

ODD = Odd parity required.
 EVEN = Even parity required
 NONE = "1"s or "0"s required (depends on the setting of keyboard interface switch Z).

Speed Switches. Block protocols can be used at speeds from 300 to 9600 baud. Speed selections outside this range are ignored. Keyboard speed settings can only be made for asynchronous operation. Synchronous communications speeds are selected on the Synchronous Communications Interface or are supplied by the modem.

Figure 5-13. Block Keyboard Data Communication Switches

MULTIPOINT COMMUNICATIONS

The terminal is capable of operating in a polled multipoint environment. This means that one or more terminals can share the same communication line. The terminal can be used in networks using asynchronous or synchronous communications. Operation is similar to IBM Bisynchronous communications. Multipoint operation requires the following:

- All communications follow a strict protocol.
- Each terminal must have an address that is unique within its communication line.
- Data is transmitted in blocks.
- All data transfers are initiated by the computer.
- All terminals on the same communication line must use the same code (ASCII/EBCDIC) and parity.

MULTIPOINT PROTOCOL. The terminal uses a multipoint protocol that is similar to IBM Bisync. The protocol is made up of sequences of one or two control characters. Table 5-10 contains a list of the control characters used along with a short description.

PA and PF Key Functions. Multipoint operation allows you to enter an escape sequence to select operation comparable to the CLEAR, PA, and PF keys on the IBM 3270 terminal. The escape sequence can be entered from the keyboard or a tape unit. The PA and PF functions allow you to send a single character to the computer. Then depending on how the computer is programmed, it can use this character to branch to various data handling routines.

The escape sequence is as follows:

```
ESC & g ### {F or A}
```

where:

is the octal code of the character to be transmitted. It can be made up of 0 to 3 octal digits. This character must have an octal code in the range 040 to 176. Note that the DELETE character (octal 177) cannot be used.

PA Operation. If the last character of the escape sequence is an A, it will cause the single character indicated by the octal code to be sent to the computer the next time the terminal is polled. This is done by creating a new text block in the output buffer.

Example: ESC & g 122 A This would cause the following text block to be sent to the computer:

```
<STX><GID><DID><R><ETX><BCC><PAD>
```

PF Operation. If the last character in the escape sequence is an F, it will cause the defined character together with the data currently displayed on the terminal screen to be sent to the computer the next time the terminal is polled.

Example: ESC & g 120 F This would cause the following text block to be sent to the computer:

```
<STX><GID><DID><P><screen data>
<ETX><BCC><PAD>
```

Note that if the screen data exceeded the terminal block size the transmission would use the normal multiblock format.

When in IBM 3270 Extended Text mode the PF escape sequence will cause the character coded in the sequence to be sent as the AID character. (Refer to IBM 3270 Extended Text Feature.)

Example: ESC & G 120F would result in the following text block in 3270 mode:

```
<STX><GID><DID><P><CCA><CCA><screen text>
<ETX><BCC><PAD>
```

Typical Applications of the PA and PF Functions. Use of the PA and PF functions allow the computer to use a general poll to find out more than just which terminals have data ready to send. If the PA and PF functions are used the character returned from each terminal can be used to determine whether the terminal has data, no data, a large amount of data, or high priority data. For example the terminal's programmable function keys (F1-F8) can be programmed with the following sequences:

```
F1 = ESC & g 110F ( H= high priority, text follows)
F2 = ESC & g 114A ( L= one line of text ready)
F3 = ESC & g 116A ( N= no data ready)
F4 = ESC & g 120A ( P= full page of text is ready)
```

The computer can then respond by polling the individual terminals in a logical order after allocating the necessary resources required for each transfer.

TERMINAL ADDRESSES. Each terminal on a communications line must have an address that is unique on that line. (The same address can be used on a different line). An address is made up of a one character group ID and a one character device ID. This address is set on the data comm interface during installation. The characters that can be used are @, A through Z, and SPACE. This allows for 28 groups of up to 28 terminals each.

The terminal id characters are listed in table 5-13. The characters in column 1 are used for group and device ids in polling sequences and for device ids in select sequences. Characters in column 2 are used for group ids in select

Data Communications

sequences. The lower case group ids let the terminal tell a poll sequence from a select sequence. Figure 5-14 gives an example of terminal address assignments.

Table 5-13. Terminal Address Characters

GROUP OR DEVICE NUMBER	COLUMN 1 USED FOR: *DEVICE ID *GROUP ID FOR POLL *ID RETURN ADDRESS			COLUMN 2 USED FOR: *GROUP ID FOR SELECT		
	ASCII I/O CHAR	ASCII HEX	ASCII OCTAL	ASCII I/O CHAR	ASCII HEX	ASCII OCTAL
0	@	40	100		60	140
1	A	41	101	a	61	141
2	B	42	102	b	62	142
3	C	43	103	c	63	143
4	D	44	104	d	64	144
5	E	45	105	e	65	145
6	F	46	106	f	66	146
7	G	47	107	g	67	147
8	H	48	110	h	68	150
9	I	49	111	i	69	151
10	J	4A	112	j	6A	152
11	K	4B	113	k	6B	153
12	L	4C	114	l	6C	154
13	M	4D	115	m	6D	155
14	N	4E	116	n	6E	156
15	O	4F	117	o	6F	157
16	P	50	120	p	70	160
17	Q	51	121	q	71	161
18	R	52	122	r	72	162
19	S	53	123	s	73	163
20	T	54	124	t	74	164
21	U	55	125	u	75	165
22	V	56	126	v	76	166
23	W	57	127	w	77	167
24	X	58	130	x	78	170
25	Y	59	131	y	79	171
26	Z	5A	132	z	7A	172
27	SP	20	040	-	2D	055

EXAMPLES	
POLL DEVICE 6 in GROUP 20	
GROUP ADDR	TT
DEVICE ADDR	FF
SELECT DEVICE 6 in GROUP 20	
GROUP ADDR	tt
DEVICE ADDR	ff

The first 'group' shown in figure 5-14 contains three terminals. Two of the terminals have the same group id character. Terminals with the same group id can be controlled by group function commands sent from the computer. Group functions allow you to address all terminals having the same group id simultaneously. In this way a single command can be used to send a message to up to 28 terminals. Similarly, all of the terminals in a group can be requested to send data to the computer. The terminals send data according to their position in the group, the terminal closest to the communication line being first.

Note that all terminals in the same group must be connected to the same modem.

Additional information on terminal addresses is given under Polling and Selection. Procedures for installing multipoint networks are given in Section VII Installation.

Terminal I.D. Number. Each terminal in a multipoint network must be assigned a unique identification number. The identification number is made up of a Group I.D. number (GID) and a Device I.D. number (DID). The terminal I.D. number is set by switches on the data communications interface printed circuit assemblies (02640-60106 or 02640-60107).

Device I.D. Number. The Device I.D. number may be 0 to 27 and is set with switches J14 through J10. Each bit corresponds to a power of 2. If the number is set to a number greater than 27, the terminal will set the number to 27. For example, Device 6 would be set with the following switch configuration:

```

Device ID = 6
J14 (closed)
J13 (closed)
J12 (open)   = 22 = 4
J11 (open)   = 21 = 2
J10 (closed)
-----
6
    
```

Group I.D. Number. The Group I.D. number may be 0 to 27 and is set with switches J04 through J00. Each bit corresponds to a power of 2. In order to use group functions, all terminals in a group must be "daisy chained" together (connected to the same modem if a modem is used).

If the I.D. is set to a number greater than 27, the terminal will set the I.D. to 27. For example, Group 20 would be set with the following switch configuration:

```

Group ID = 20
J04 (open) = 24 = 16
J03 (closed)
J02 (open) = 22 = 4
J01 (closed)
J00 (closed)
-----
20
    
```

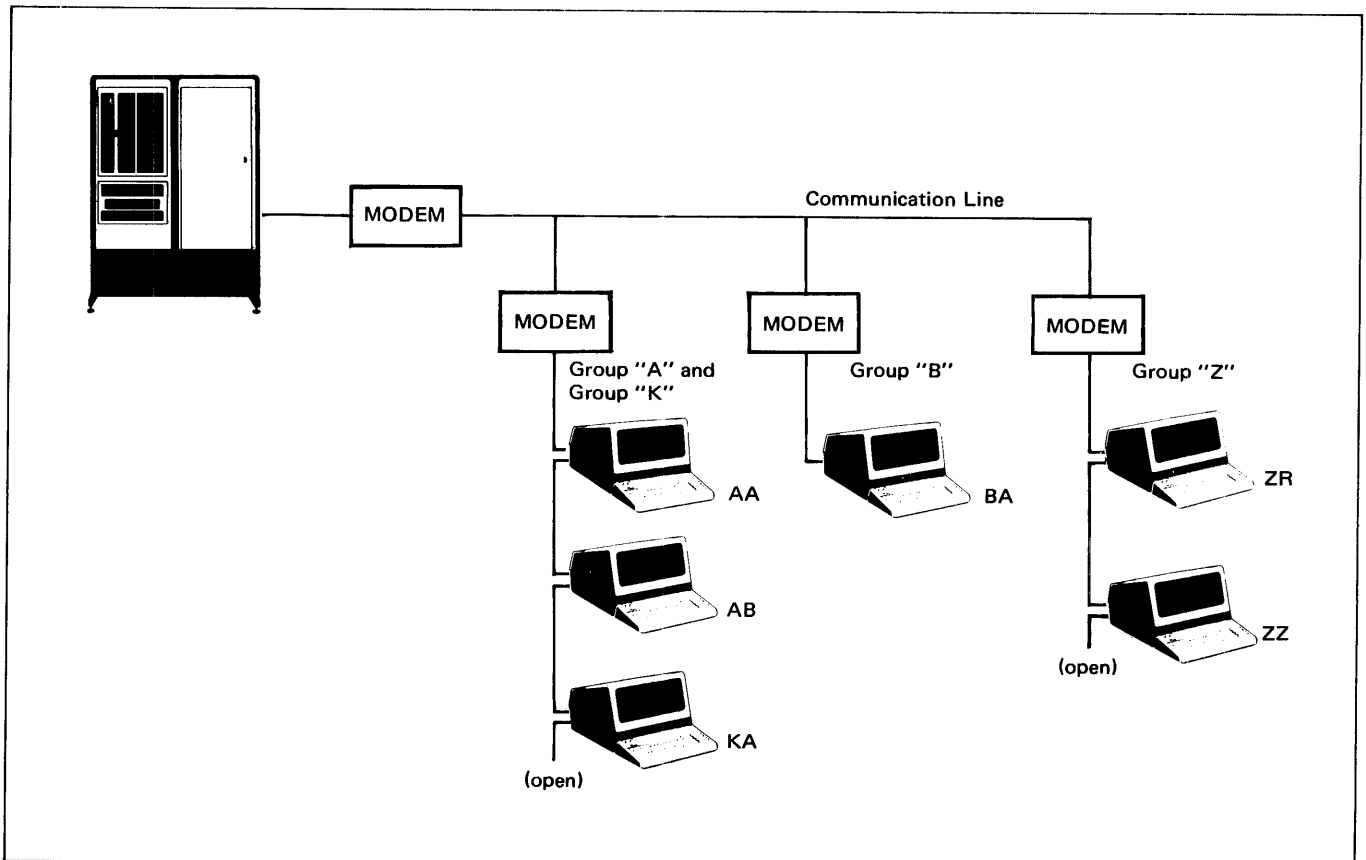



Figure 5-14. Terminal Addressing

INITIATION OF A DATA TRANSFER. All data transfers are initiated by the computer in one of two ways, Polling or Selection. In both cases, device addresses are used to call a specific terminal or group of terminals.

CONTROL SEQUENCES

Polling. The computer requests terminals with data ready for transmission to begin sending by "polling" the

terminals. The terminals can then respond in order according to their position on the communication line. Those at the far end of the communication line being held off until all terminals ahead of them on the string have completed their data transfers.

For example, a poll of terminal D in group A would consist of the following character sequences:

Asynchronous

```
<EOT><PAD><GROUP ID><GROUP ID><DEV ID><DEV ID><ENQ>PAD>
```

E	P	A	A	D	D	E	P
O	A					N	A
T	D					Q	D

Synchronous

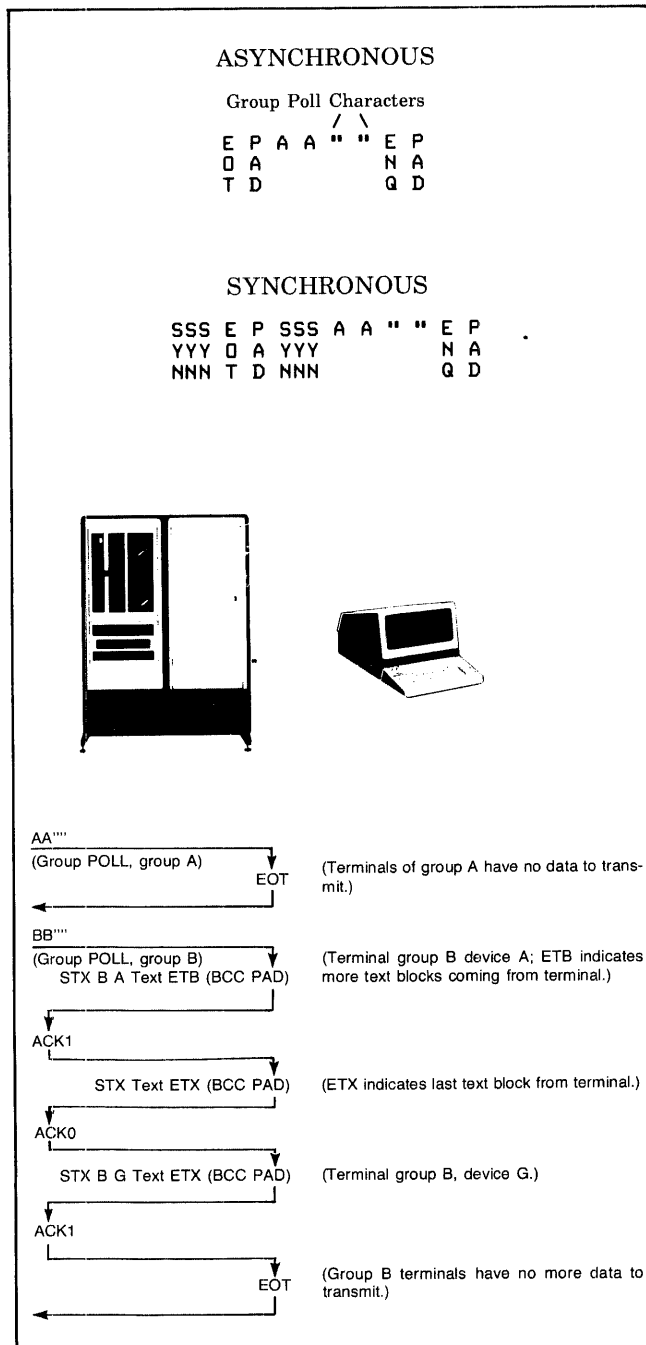
```
<SYN*><EOT><PAD><SYN*><GROUP ID><GROUP ID><DEV ID><DEV ID><ENQ><PAD>
```

SSS	E	P	SSS	A	A	D	D	E	P
YYY	O	A	YYY					N	A
NNN	T	D	NNN					Q	D

*3 or more SYN characters

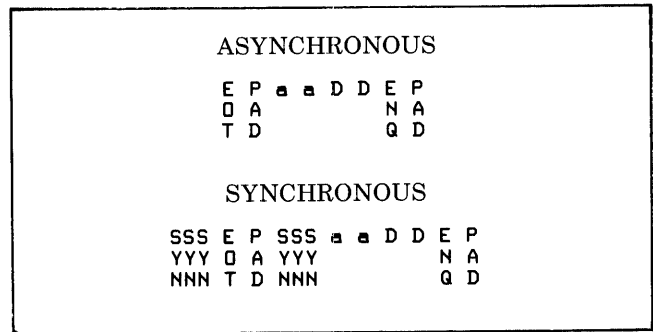
Group Polling. In order to reduce the time and programming required to poll each terminal on a communication line you can perform a group poll. This will allow all of the terminals in a group (terminals having the same group id) with data ready to send, to respond to a single poll sequence. When the last terminal in the group with data to transfer is through sending it will send an EOT to indicate that the group has finished.

The group poll sequence is similar to the normal poll sequence. The " character (042 octal) is used in place of the device id characters. For example, to poll all of the terminals in group A you can use the following sequence:

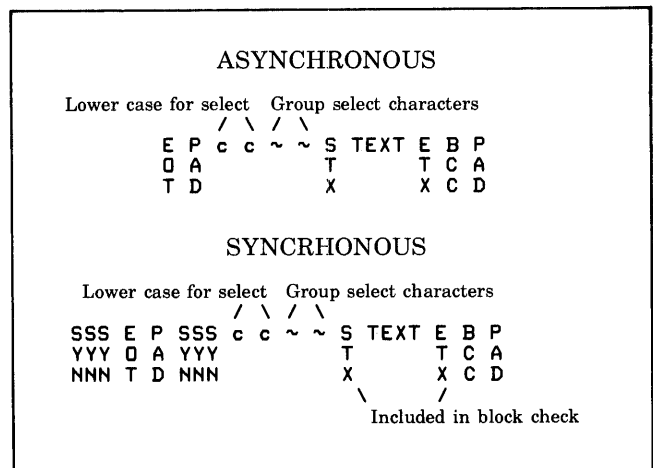


Selection. "Selection" occurs when the computer directs a specific terminal or group of terminals to accept a data transmission. The character sequences used in selection are the same as those used in polling. The only difference is that the lower case id characters are used. This is to tell the terminals that a selection is being sent instead of a poll. For example, to address the same device as in the polling example, the sequence would be as follows:

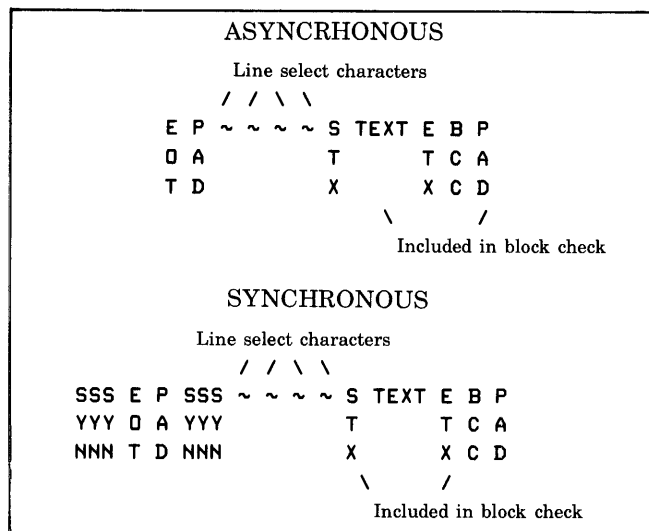
Note that both the group id and device id characters are transmitted twice to eliminate line errors during Poll and Select sequences. (These transmissions do not use Block Check characters.) The two group id characters must be the same and the two device id characters must be the same for a terminal to accept a poll or select sequence. Then, if the group and device ids are the same as the terminal's, the terminal will respond.



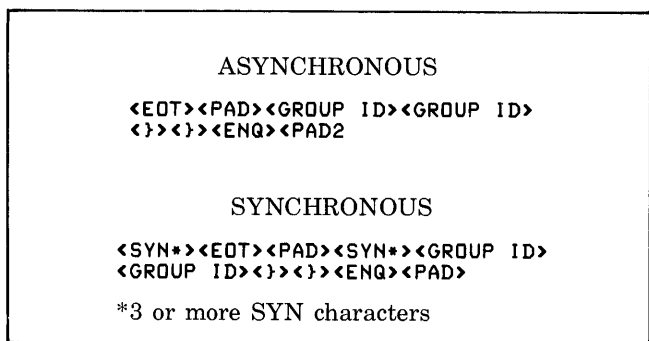
Group Select. A "group select" sequence can be used to send data to all of the terminals in a group. The terminals will not send any response to group select. The text transmission is appended directly to the end of the group select sequence. The group select is the same as a device select sequence except that the device id character is replaced with a tilde (~) (octal 176). For example, to send data to all of the terminals in group C the following sequences would be used:



Line Select. A "line select" allows you to select all of the terminals on a communication line. This is also known as "Broadcast" mode. Both the group and device id characters are replaced with tildes (~).



CONFIGURATION STATUS — WHO ARE YOU (WRU). The Who Are You (WRU) control sequence is a status request from the computer to a terminal group. It is similar to a group poll except that the terminal's respond with status information instead of the normal text data. All terminals in the group that are turned on will send in their status. The status sequence is shown below. The right brace character (175 octal) is used in place of the device id. This tells the terminal that a status request is being made.



Three bytes of status information are returned for each responding terminal. Figure 5-15 shows a typical status request and responses from a terminal group.

The status bytes contain terminal hardware and firmware configuration information. The content of each of the status bytes is explained in figure 5-16.

EXTENDED TEXT FEATURE/SYNCHRONOUS COMPATIBILITY. The IBM Extended Text Feature is selected by setting the J05 switch on the synchronous multipoint interface to the 1 (open) position. On the asyn-

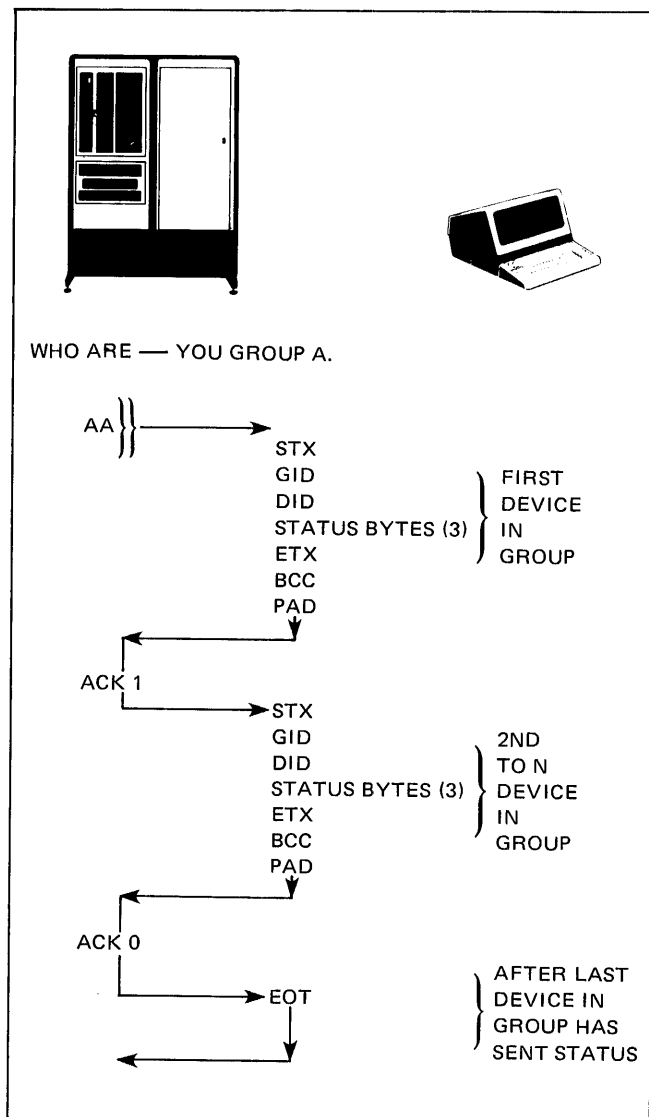
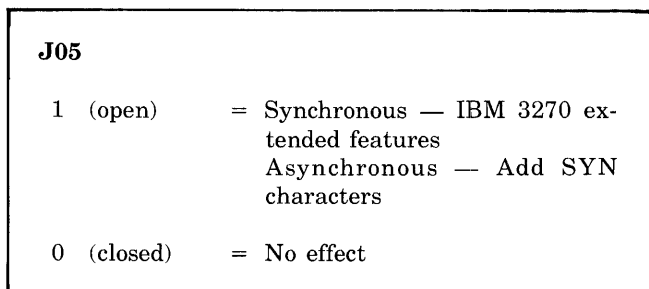
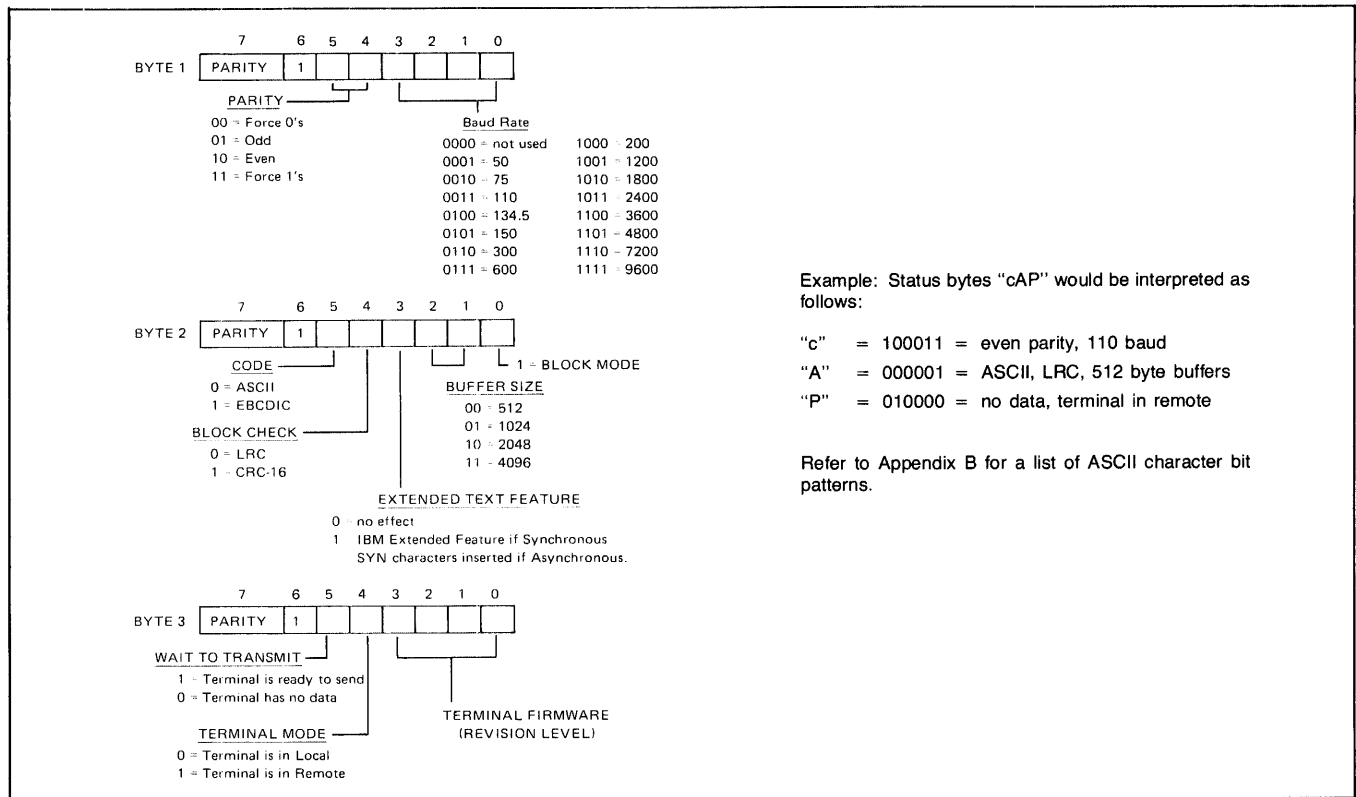


Figure 5-15. Typical Configuration Status Request and Response Sequence

chronous multipoint interface this switch selects the synchronous compatibility feature.





Example: Status bytes "cAP" would be interpreted as follows:

- "c" = 100011 = even parity, 110 baud
- "A" = 000001 = ASCII, LRC, 512 byte buffers
- "P" = 010000 = no data, terminal in remote

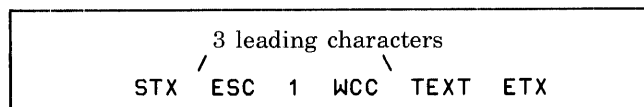
Refer to Appendix B for a list of ASCII character bit patterns.

Figure 5-16. Configuration Status Byte Contents

Asynchronous Operation. In asynchronous configurations this setting causes SYN characters to be inserted in data transmissions. This allows the use of a single generalized data communication driver for both synchronous and asynchronous operation.

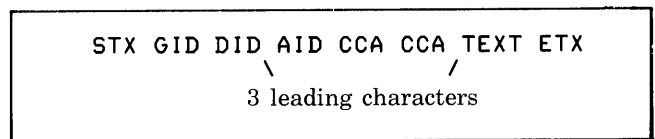
Synchronous Operation. When used in synchronous configurations the terminal can be set to generate and delete three special characters used with an IBM 3270 terminal.

After the computer has selected the terminal to receive data, the first text block will have the following form:



Note that the characters follow STX and precede the text block. Since these characters are not used by the terminal, they would normally be accepted as a part of the text block. Selecting the IBM Extended Text feature will cause the terminal to discard these three characters before processing the text.

When the first block of text is sent to the computer in response to a POLL sequence, the computer expects to see the following:



The leading characters that are sent by the terminal are as follows:

AID — attention I.D. This character will always be 27 octal ('027'). If you use the PA or PF functions refer to their descriptions earlier in this section.

CCA — Current Cursor Address. This is a two character address and will always be 0, 0 ('040 040'). This is the cursor home position.

Note that if you have configured the terminal for text mode compatibility and are not operating with such a system, the first three characters in the first text block received will be lost. Also, the three leading characters (AID, CCA, CCA) will be embedded in the transmitted text block.

CONFIGURATION PROCEDURE

After you have determined the required multipoint settings for your application follow the flowchart given in figure 5-17.

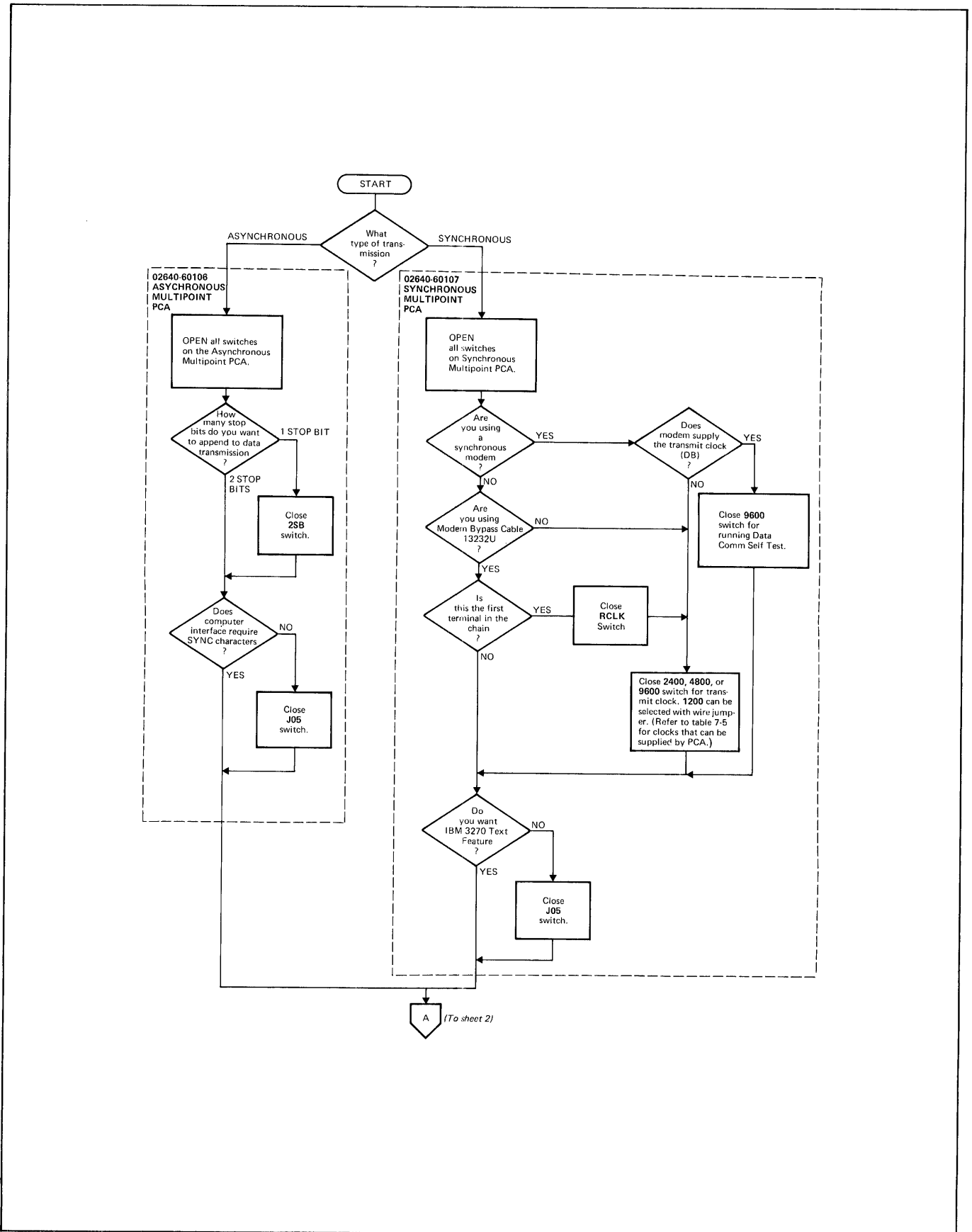


Figure 5-17. Multipoint Data Communications Configuration (Sheet 1 of 4)

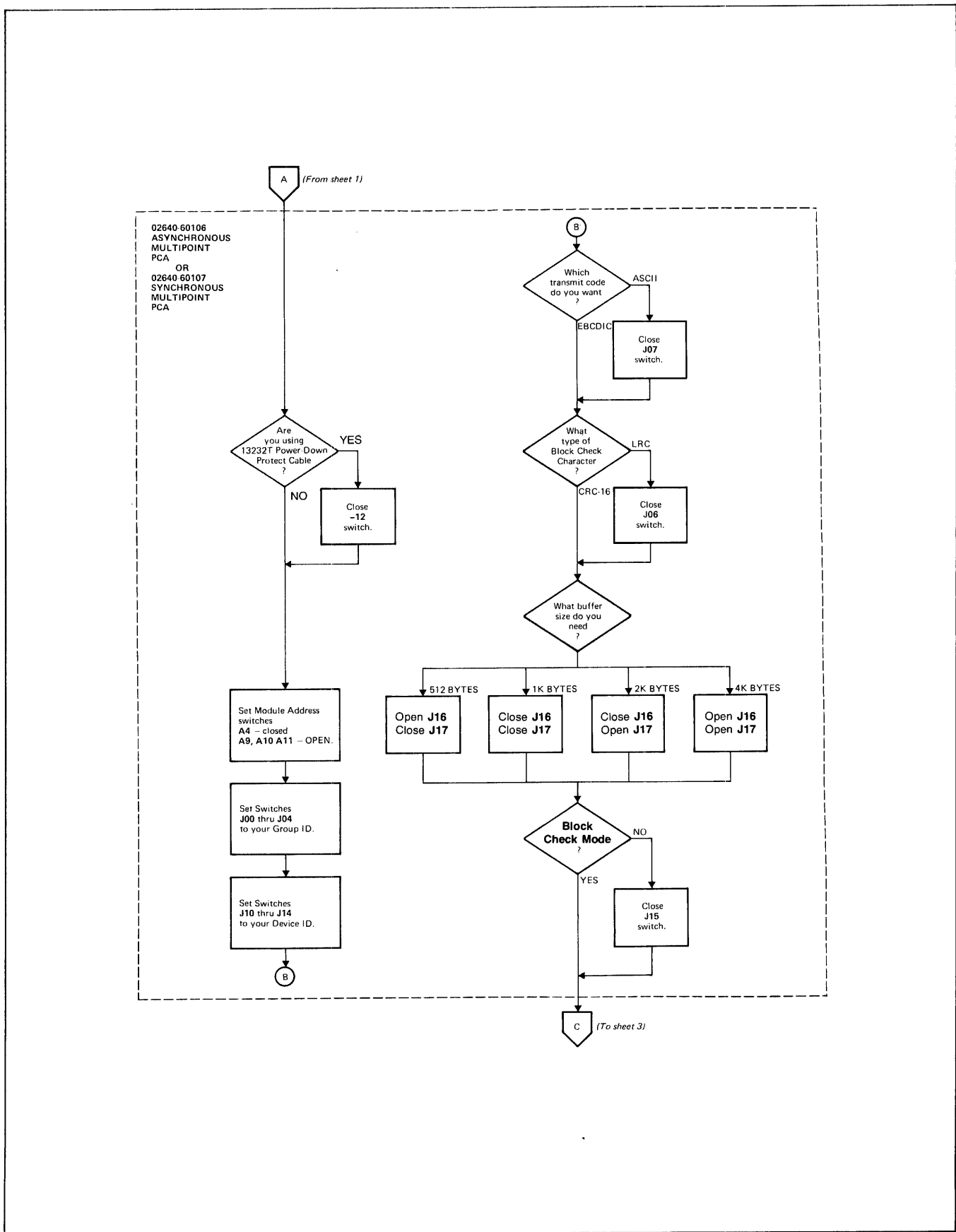
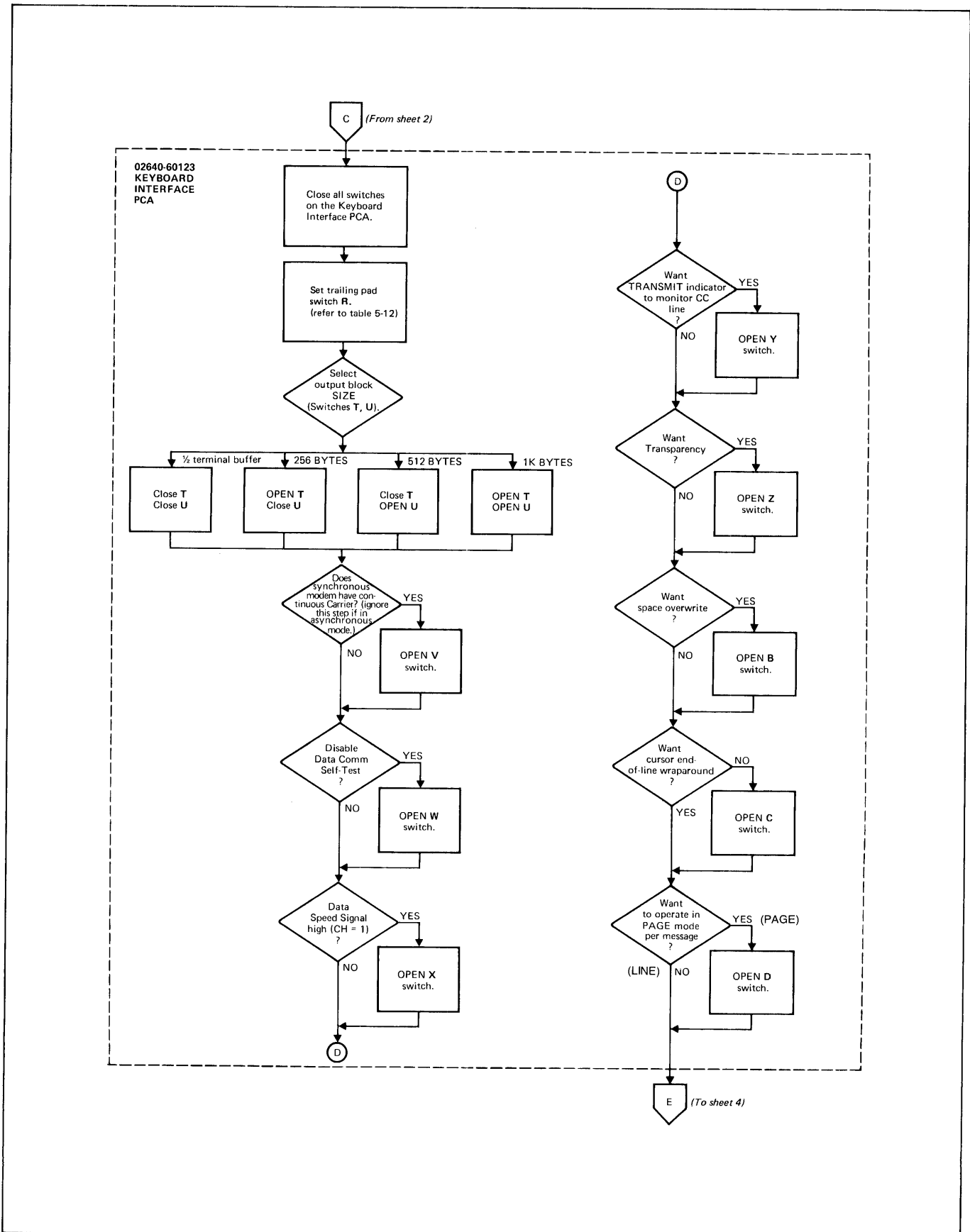


Figure 5-17. Multipoint Data Communications Configuration (Sheet 2 of 4)



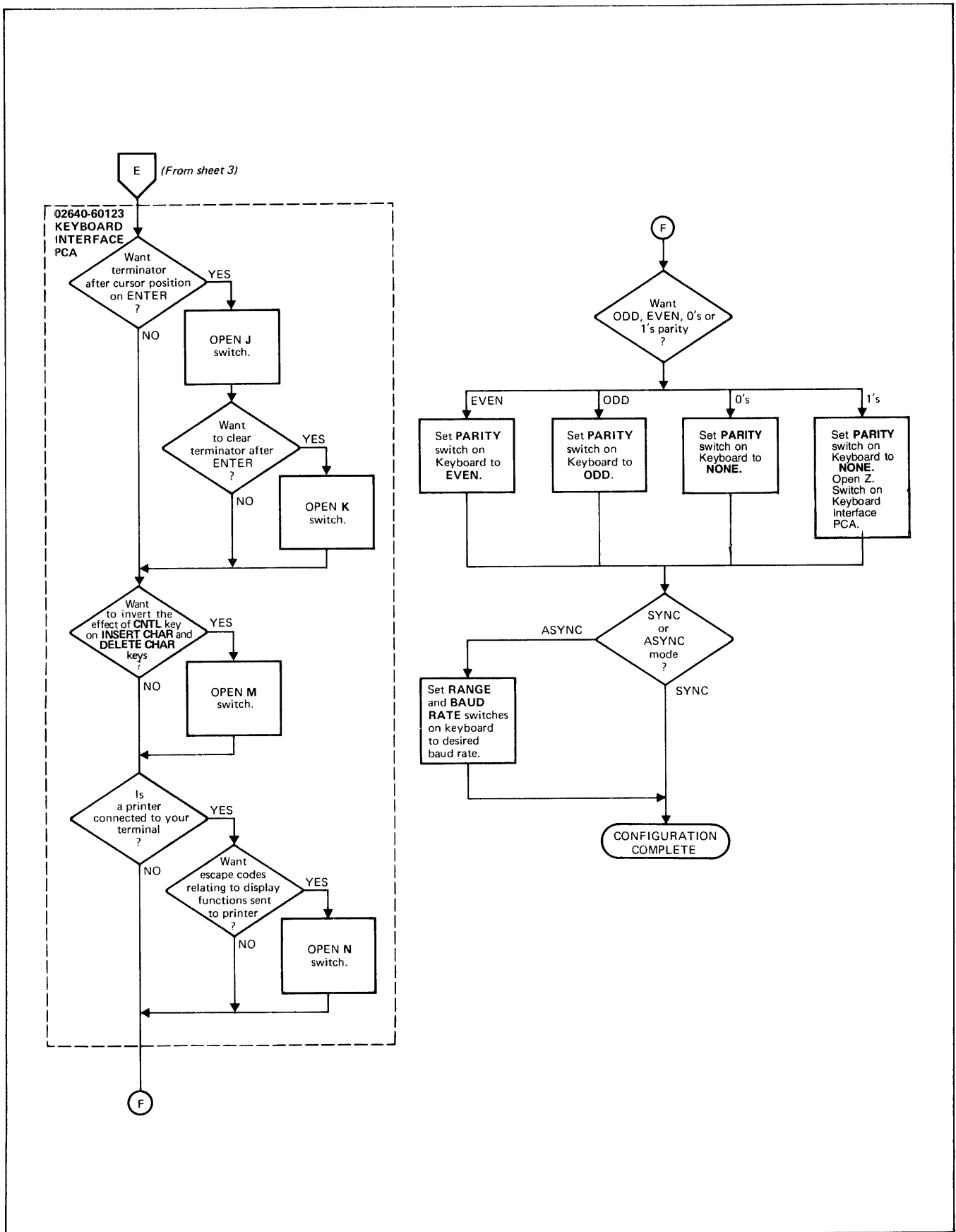


Figure 5-17. Multipoint Data Communications Configuration (Sheet 4 of 4)

MONITOR MODE

Monitor mode is an added multipoint feature available as an option to the 13260C and 13260D interfaces. It allows a terminal to monitor the data transfers between the computer or driver terminal (refer to Driver Mode) and other multipoint terminals on the same communication line. This is a useful technique when developing communications programs or testing multipoint networks.

The monitor must be placed in the line between the computer and the other terminals in order to monitor both sides of the communication exchanges. Figure 5-18 shows a sample communication line using a terminal in monitor mode. (Note that the monitor cannot detect data sent from terminal AA to the computer.)

Note that the monitor will not respond to poll or select sequences addressed to it while in Monitor Mode.

Once the Monitor option has been installed (refer to Section VII Installation for procedures), Monitor mode is selected by the following:

Step 1. RESET, RESET ( key down).

Step 2.   (The DISPLAY FUNCTIONS indicator should begin blinking.)

Pressing the DISPLAY FUNCTIONS key again will turn off the indicator and return the terminal to normal operation.

While in Monitor mode data communications between the computer and "downstream" terminals will be displayed on the monitor. Data from terminals will be framed in left and right arrows (<data>) and will include control and block check characters (see figure 5-19).

In group poll operations the last three characters of the poll sequence (second " , ENQ, PAD) may be distorted due to the response of polled terminals (see figure 5-20). Once a terminal detects the first double quote character ("), it begins its response with a transition on the Request to Send Line (CA). This causes the monitor to begin watching for data from the terminal instead of the computer. This distortion occurs only within the monitor and does not affect the operation of either the computer or the other terminals.

If the monitor terminal is configured with a communications buffer that is smaller than any of the computer or responding terminals, a data overflow may occur. A cancel character (octal 030) will be displayed at the point where the data overflow occurred (see figure 5-21). To prevent data overflow, make sure that the buffer used in the monitor is at least as large as the largest buffer used by any responding terminal. (Refer to the Installation section for buffer configuration information.)

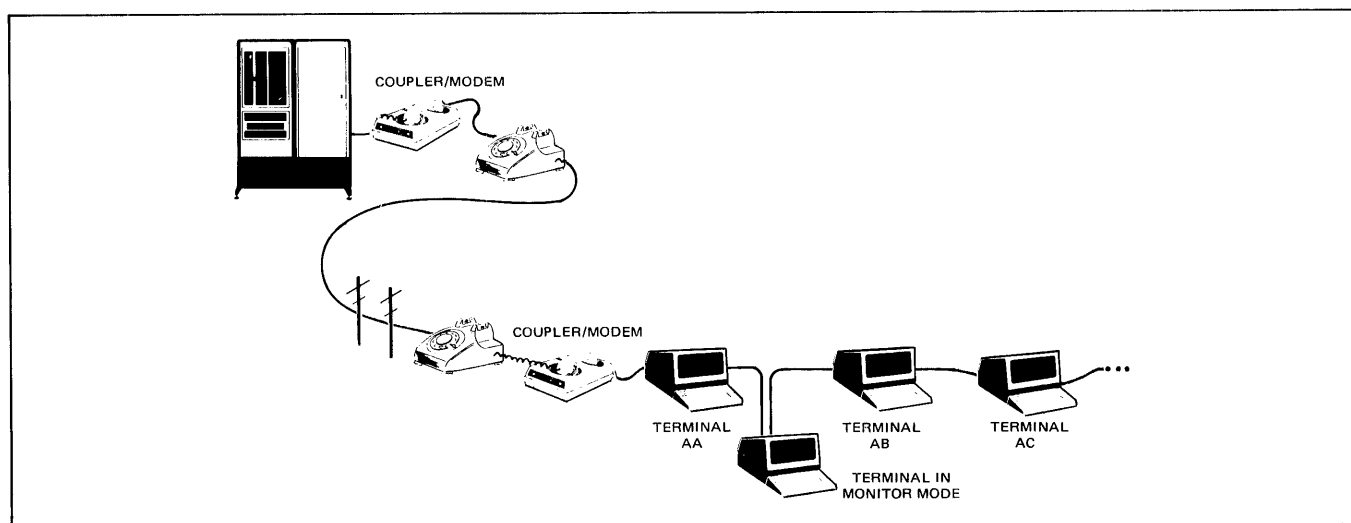


Figure 5-18. Communication Line Using a Monitor

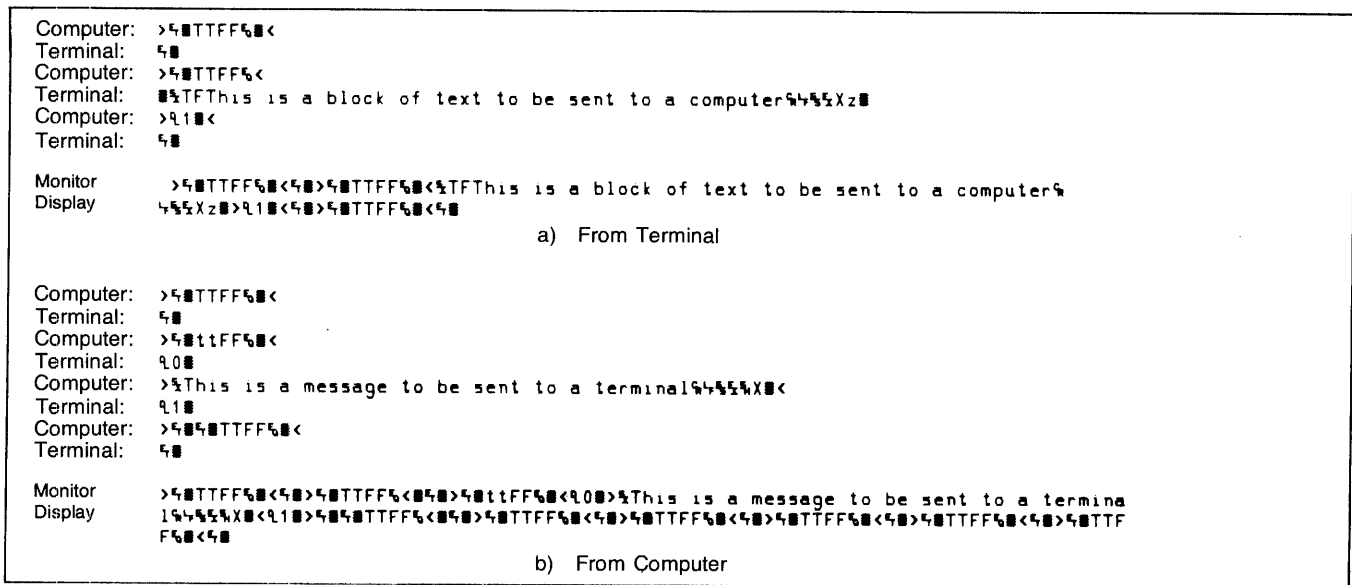


Figure 5-19. Sample Data Transfers Displayed in Monitor Mode

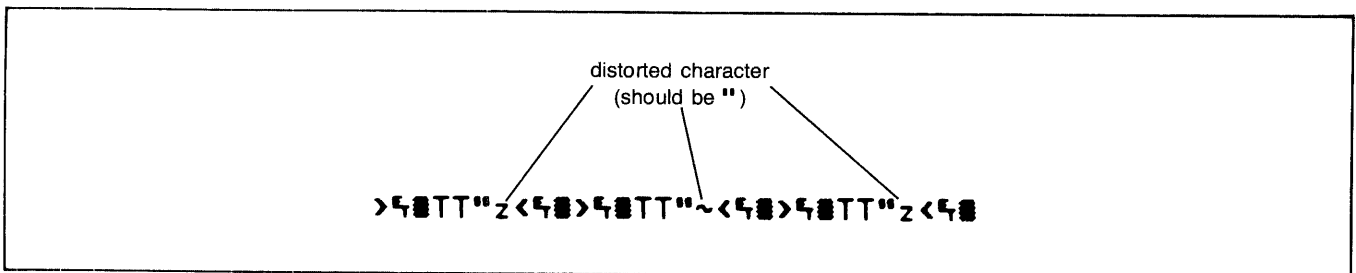


Figure 5-20. Character Distortion in Group Poll

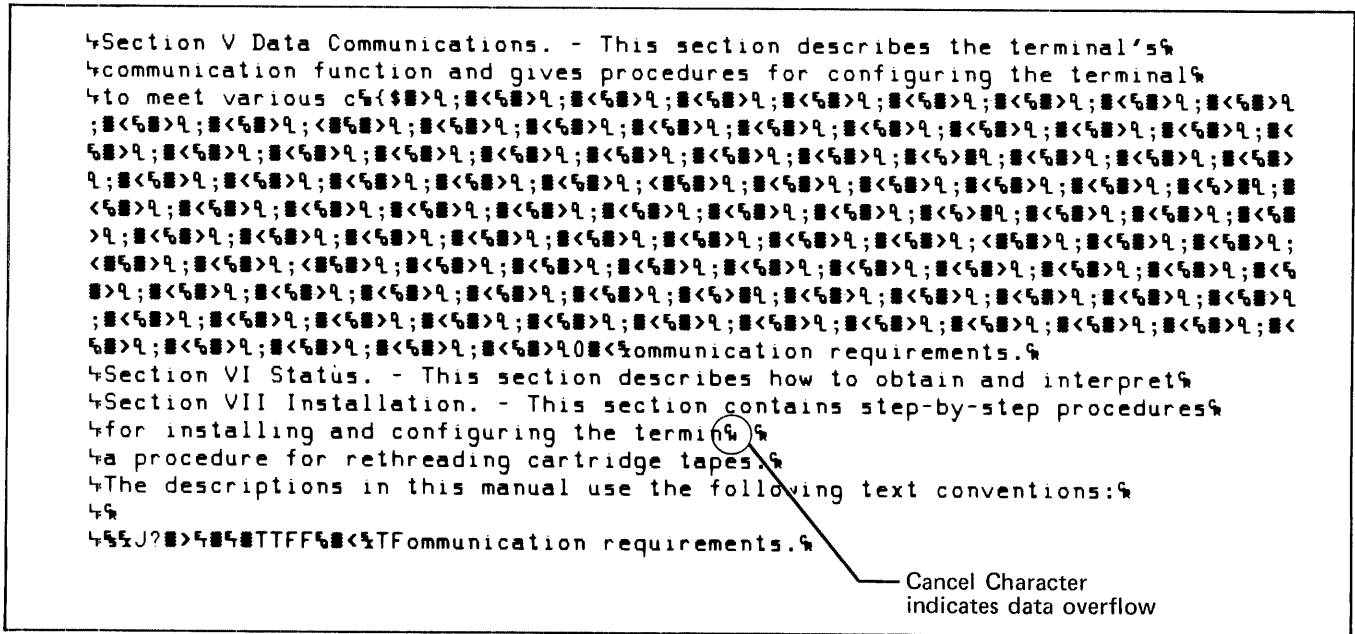


Figure 5-21. Data Overflow Indication

DRIVER MODE

Driver Mode is an additional multipoint feature available with the Monitor Mode option to the 13260C and 13260D interfaces. It allows you to use a terminal to control a multipoint communication line. This technique is very useful in developing communication drivers or testing networks without the need of a computer or modem.

Figure 5-22 shows two typical networks using the driver mode option. The network in figure 5-22a is the simplest case. A more useful network is shown in figure 5-22b. Here a multiterminal network is being driven while a terminal in monitor mode is used to display or record all communication transactions. All data from the downstream terminals as well as the driver terminal is displayed.

Once the Monitor/Driver Mode option has been installed (refer to Section VII Installation for installation procedures), Driver mode is selected as follows:

Step 1. RESET,RESET

Step 2. Type DVR-<GID DID><gid DID>

where: GID DID = the group and device ids to be used in poll sequences.



gid DID = the group and device ids to be used in select sequences.

Examples:

DVR-ABaB (uses terminal B in group A for both poll and select)

DVR-A^aaB (polls all terminals in group A but selects only terminal B)

Step 3. ENTER

Step 4.   (The DISPLAY FUNCTIONS indicator should blink)

The Driver will begin sending out the polling sequence at 4 to 5 second intervals using the poll id characters loaded with the ENTER key. You can also type in text to be sent to the terminal identified for select operations. Block transfers are triggered by the ENTER key.

Example: This is a block of text to be sent to a terminal.

This line would be sent to and displayed on the destination terminal just as it was typed. Note that if a monitor terminal were in the network between the driver terminal and the destination terminal it would display all of the framing characters as well as the block check character. Figure 5-23 shows the way this transfer would appear.

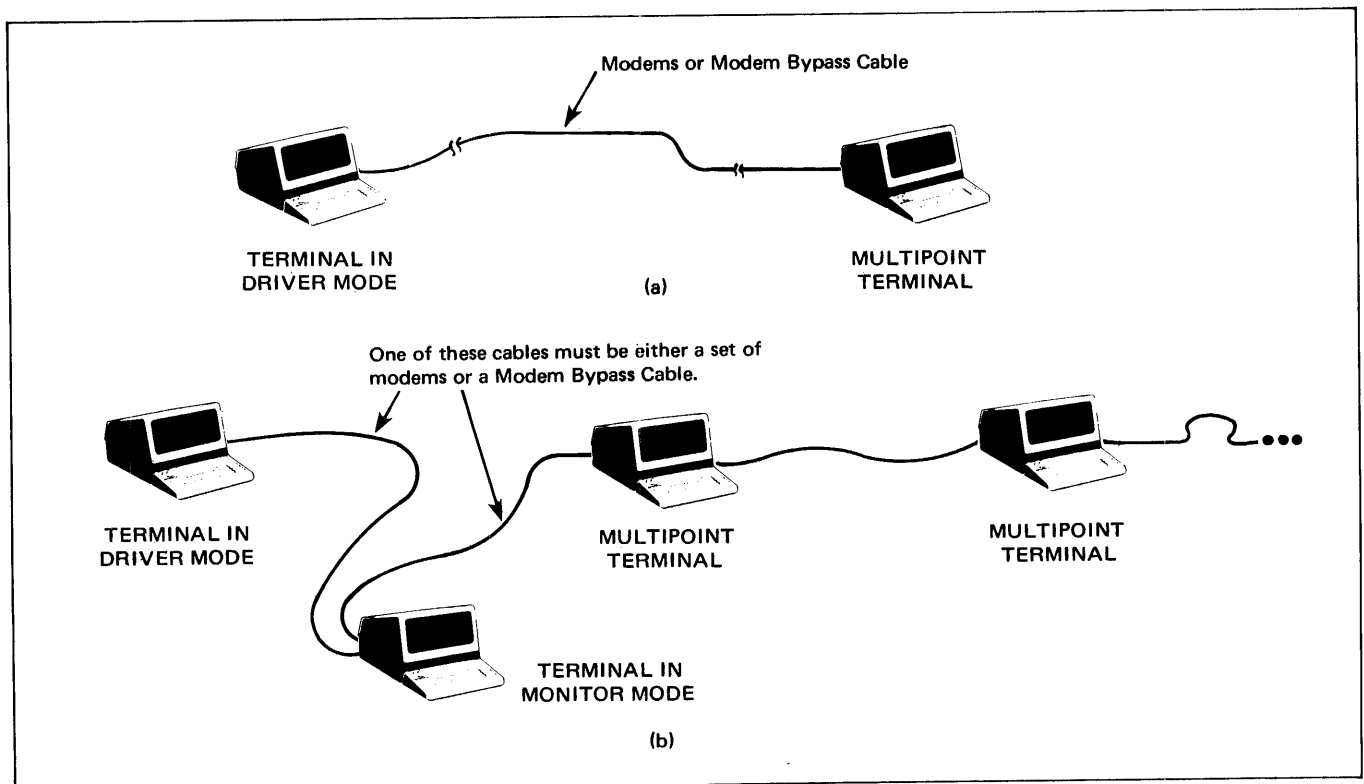


Figure 5-22. Driver Mode Configurations

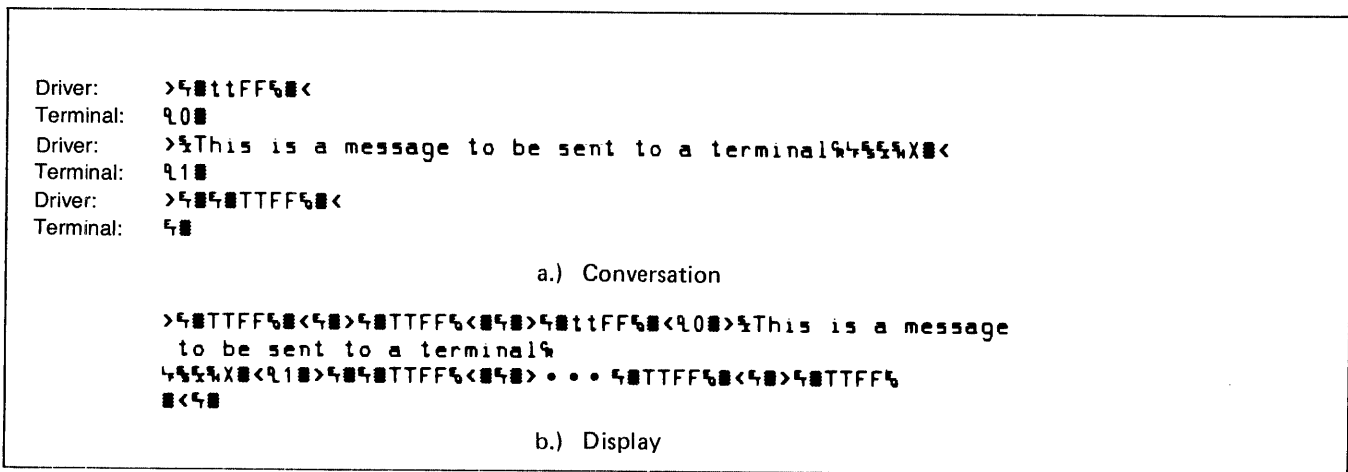


Figure 5-23. Sample Select Sequence Using Driver Mode

Normally all 128 ASCII characters are displayed on the screen of the driver terminal. You can press the DISPLAY FUNCTIONS key (indicator goes out) and still remain in driver mode. This will prevent control characters from being displayed (see figure 5-24).

Data can be transferred from a multipoint terminal to the driver terminal by entering the data and pressing the ENTER key. The terminal will then respond to a poll sequence by sending the data the same as it would in normal multipoint operation (see figure 5-25).

A full reset returns the driver terminal to normal operation.

All multipoint group functions except broadcast can be used in driver mode. Note that you can poll an entire group but can only address one terminal with a select sequence.

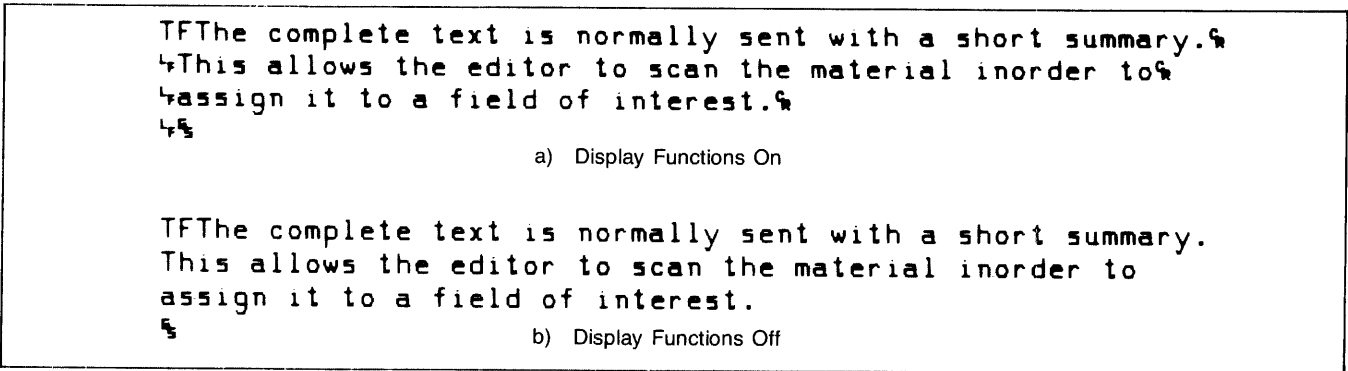


Figure 5-24. Control Character Display On Driver Terminal

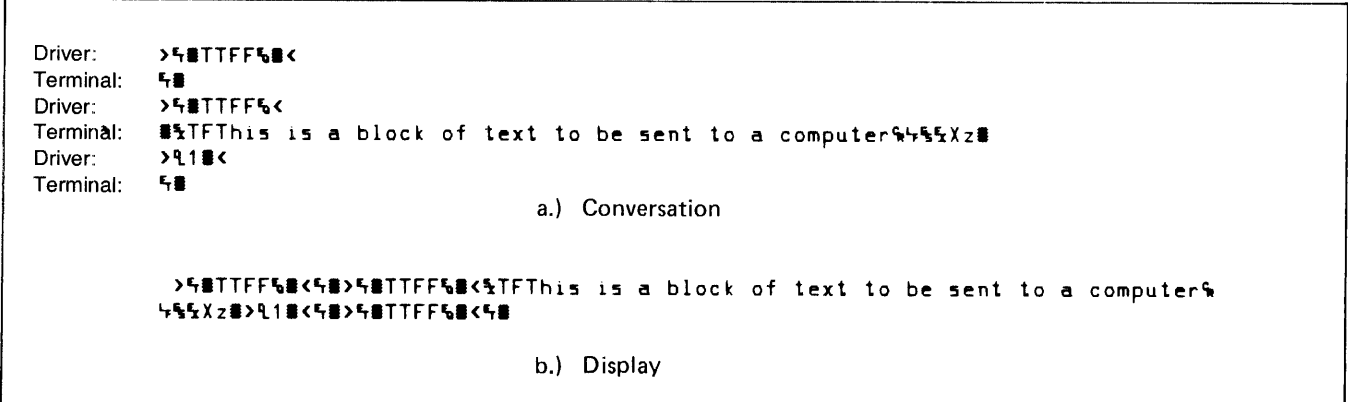


Figure 5-25. Terminal Input

INTRODUCTION

This section contains information on how to obtain and interpret terminal status information. In addition to terminal status, you can also obtain status information on input/output devices used with the terminal.

Status requests are made by sending an escape code sequence to the terminal to select the desired status information. All status requests are treated as block transfers. (Refer to Multicharacter Transfers in Section V). The examples that follow use the DC1 character to trigger the status transfer (Basic Communication Protocol).

INTERPRETING STATUS

In response to status requests the terminal returns an escape code sequence followed by one or more bytes. The status bytes are followed by a terminator. The terminator received may be a CR(LF), RS or GS depending on the communications protocol and terminal configuration (refer to Section V). The examples that follow use the CR character as a terminator.

The status information is contained in the lower four bits of each status byte. The upper four bits of the bytes are set so that the byte will have the value of an ASCII character. Each byte can be interpreted as one of 16 characters as follows:

ASCII CHARACTER	BINARY
0	0011 0000
1	0011 0001
2	0011 0010
3	0011 0011
4	0011 0100
5	0011 0101
6	0011 0110
7	0011 0111
8	0011 1000
9	0011 1001
:	0011 1010
;	0011 1011
<	0011 1100
=	0011 1101
>	0011 1110
?	0011 1111

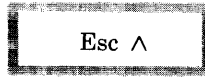
TERMINAL STATUS

Terminal status is made up of 14 status bytes (bytes 0-13) containing information such as display memory size, switch settings, keyboard interface configuration, and terminal errors. There are two terminal status requests, primary and secondary. Each returns a set of 7 status bytes. The terminal status bytes are shown on pages 6-3 and 6-5.

PRIMARY TERMINAL STATUS

The first block of terminal status (bytes 0-6) is requested by sending the following escape sequence:

Primary Terminal Status Request



The terminal will respond with an ESC \ and 7 status bytes followed by a terminator. A typical primary terminal status request and response is shown in figure 6-1. The example is for a configuration requiring the DC1 character to trigger block transfers.

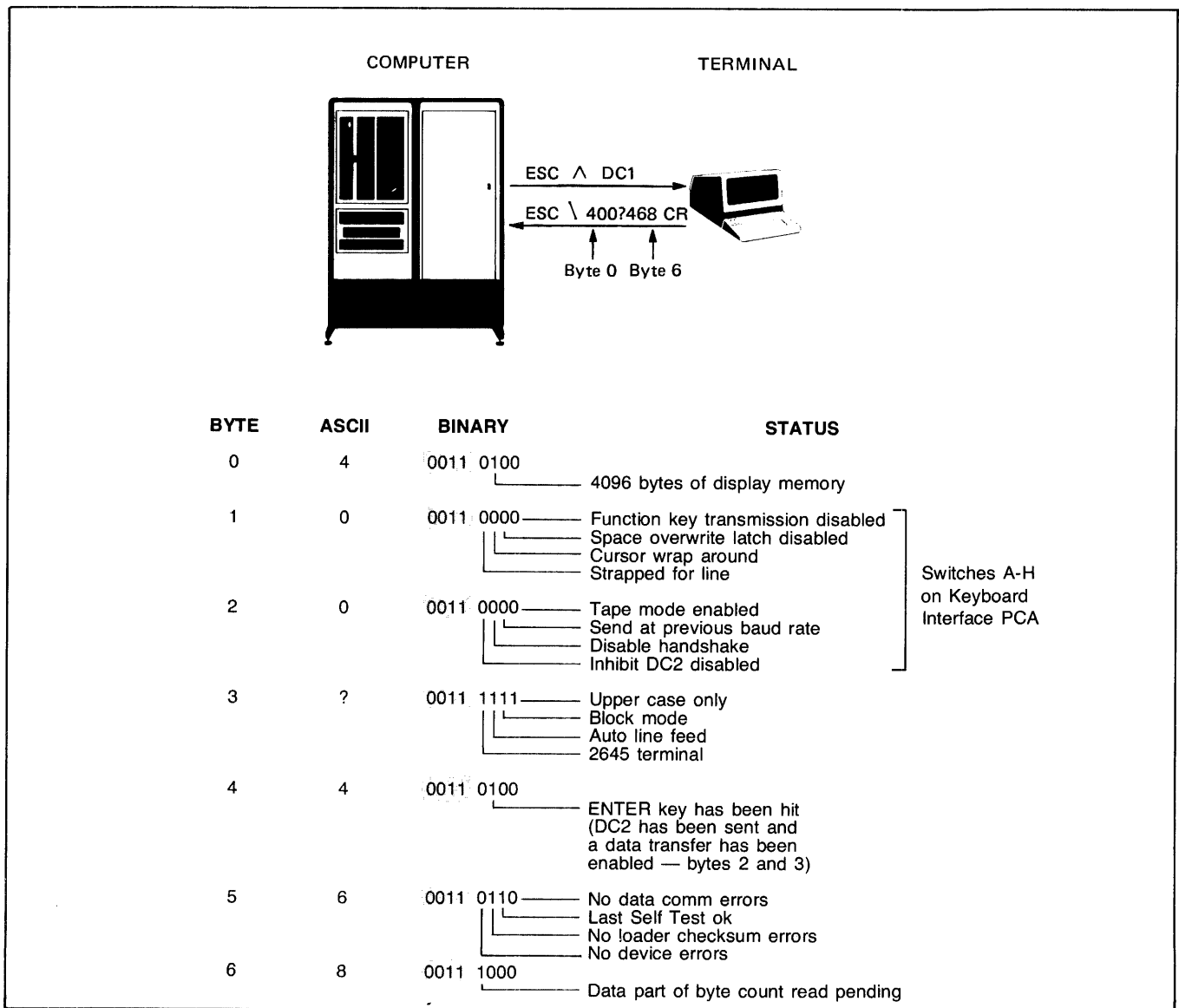
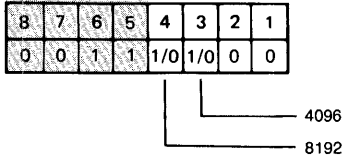


Figure 6-1. Primary Terminal Status Example

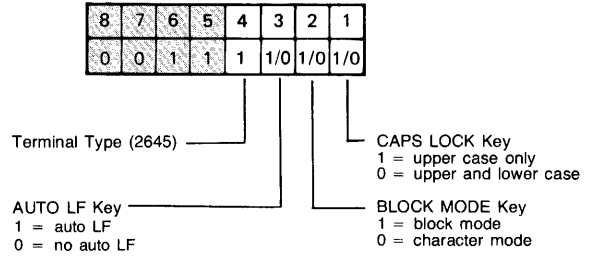
PRIMARY TERMINAL STATUS

BYTE 0 DISPLAY MEMORY SIZE

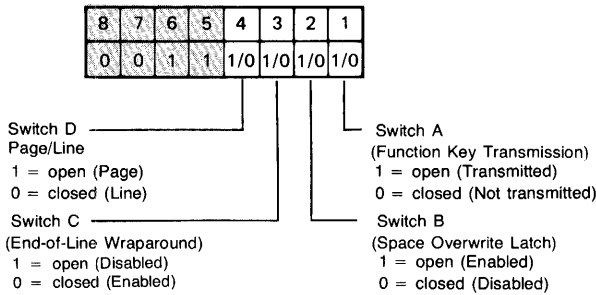


The amount of display memory (blocks of 1K) available in the terminal is returned. The amount can range from 4096 to 12,288 bytes.

BYTE 3 LATCHING KEYS

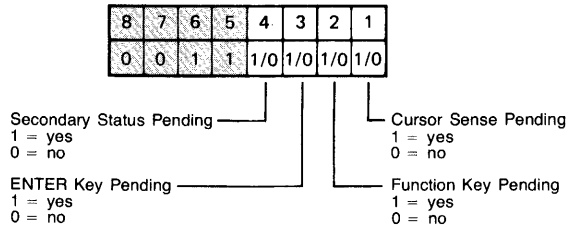


BYTE 1 KEYBOARD INTERFACE SWITCHES (A-D)

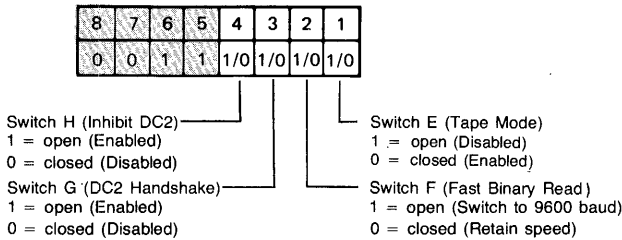


Refer to Section V for a detailed description of Keyboard Interface switches.

BYTE 4 TRANSFER PENDING FLAGS

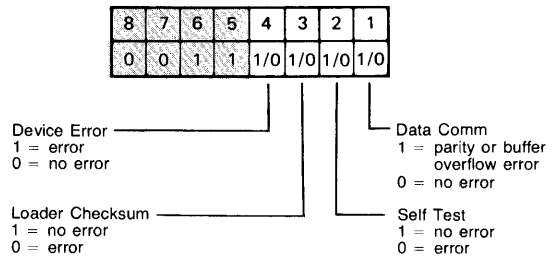


BYTE 2 KEYBOARD INTERFACE SWITCHES (E-H)

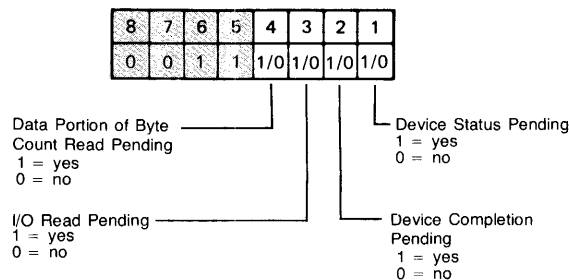


Refer to Section V for a detailed description of Keyboard Interface switches.

BYTE 5 ERROR FLAGS



BYTE 6 DEVICE TRANSFER PENDING FLAGS



SECONDARY TERMINAL STATUS

The second block of terminal status (bytes 7-13) is requested by sending the following escape sequence:

Secondary Terminal
Status Request

Esc ~

The terminal will respond with an Esc | and 7 status bytes followed by a terminator. A typical secondary terminal status request and response are shown in figure 6-2.

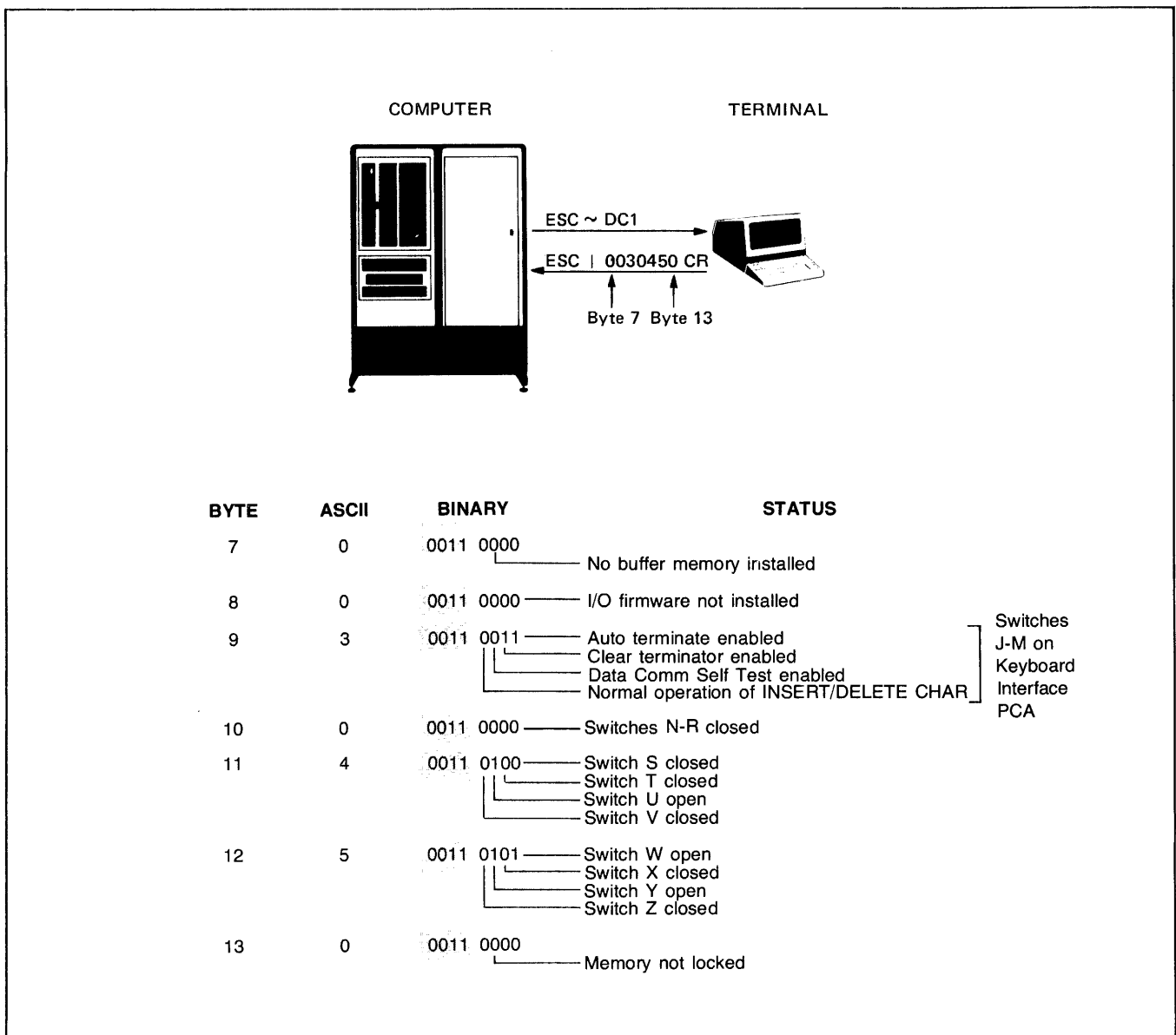


Figure 6-2. Secondary Terminal Status Example

SECONDARY STATUS BYTES

BYTE 7 BUFFER MEMORY

8	7	6	5	4	3	2	1
0	0	1	1	0	1/0	0	0

1 = 4096 bytes
0 = none

Memory installed in addition to display memory that is available for use as data buffers.

BYTE 8 TERMINAL FIRMWARE CONFIGURATION

8	7	6	5	4	3	2	1
0	0	1	1	0	0	1/0	1/0

1 = APL Firmware
0 = No APL Firmware
1 = I/O firmware installed
0 = not installed

The device support firmware is required before tape units or printers can be used with the terminal.

BYTE 9 KEYBOARD INTERFACE SWITCHES (J-M)

8	7	6	5	4	3	2	1
0	0	1	1	1/0	1/0	1/0	1/0

Switch M (Alternate Operation — INSERT and DELETE CHARACTER Keys)
1 = open (Invert wrap sense)
0 = closed (normal)

Switch L (Self Test Inhibit)
1 = open (Inhibit test)
0 = closed (Allow test)

Switch J (Auto Terminate)
1 = open (Enabled)
0 = closed (Disabled)

Switch K (Clear Terminator)
1 = open (Enabled)
0 = closed (Disabled)

Refer to Section V for a detailed description of Keyboard Interface switches.

BYTE 10 KEYBOARD INTERFACE KEYS (N-R)

8	7	6	5	4	3	2	1
0	0	1	1	1/0	1/0	1/0	1/0

Switch R (varies with communications protocol)
1 = open
0 = closed

Switch Q (not used)

Switch N Printer (Escape Code Transfer)
1 = open (Send ESC code)
0 = closed (Do not send code)

Switch P (not used)

Refer to Section V for detailed descriptions of these switches.

BYTE 11 KEYBOARD INTERFACE KEYS (S-V)

8	7	6	5	4	3	2	1
0	0	1	1	1/0	1/0	1/0	1/0

Switch V
1 = open
0 = closed

Switch U
1 = open
0 = closed

Switch S
1 = open
0 = closed

Switch T
1 = open
0 = closed

The use switches S to V varies depending on the communication protocol used. Refer to Section V for detailed descriptions of their functions.

BYTE 12 KEYBOARD INTERFACE SWITCHES (W-Z)

8	7	6	5	4	3	2	1
0	0	1	1	1/0	1/0	1/0	1/0

Switch Z (Parity)
1 = (Force Parity)
0 = (Do not Force Parity)

Switch Y (Transmit light)
1 = open (On when CC high)
0 = closed (On when CB high)

Switch W (Data Comm Test)
1 = open (Inhibit)
0 = closed (Allow)

Switch X (Speed Select)
1 = open (CH = ON)
0 = closed (CH = OFF)

The use switches W to Z varies depending on the communication protocol used. Refer to Section V for detailed descriptions of their functions.

BYTE 13 MEMORY LOCK/BI-LINGUAL MODE

8	7	6	5	4	3	2	1
0	0	1	1	1/0	1/0	0	0

1 = APL Mode
0 = ASCII Mode

1 = locked
0 = unlocked

DEVICE STATUS

The status of a tape unit or printer can be obtained by a device status request. This request would typically be made following an input/output operation or as a result of testing bytes 5 and 6 of the terminal status. The device status bytes are shown in table 6-2.

Device status is requested by sending the following escape sequence:

Device Status Request Esc & p < device code > ^

where <device> is 1, 2, or 4 and

- 1 = left tape
- 2 = right tape
- 4 = printer

The terminal will return an Esc \ p <device code> and 3 bytes of device status followed by a terminator. A typical device status request and response are shown in figure 6-3. A status request from device 3 (display) will be ignored.

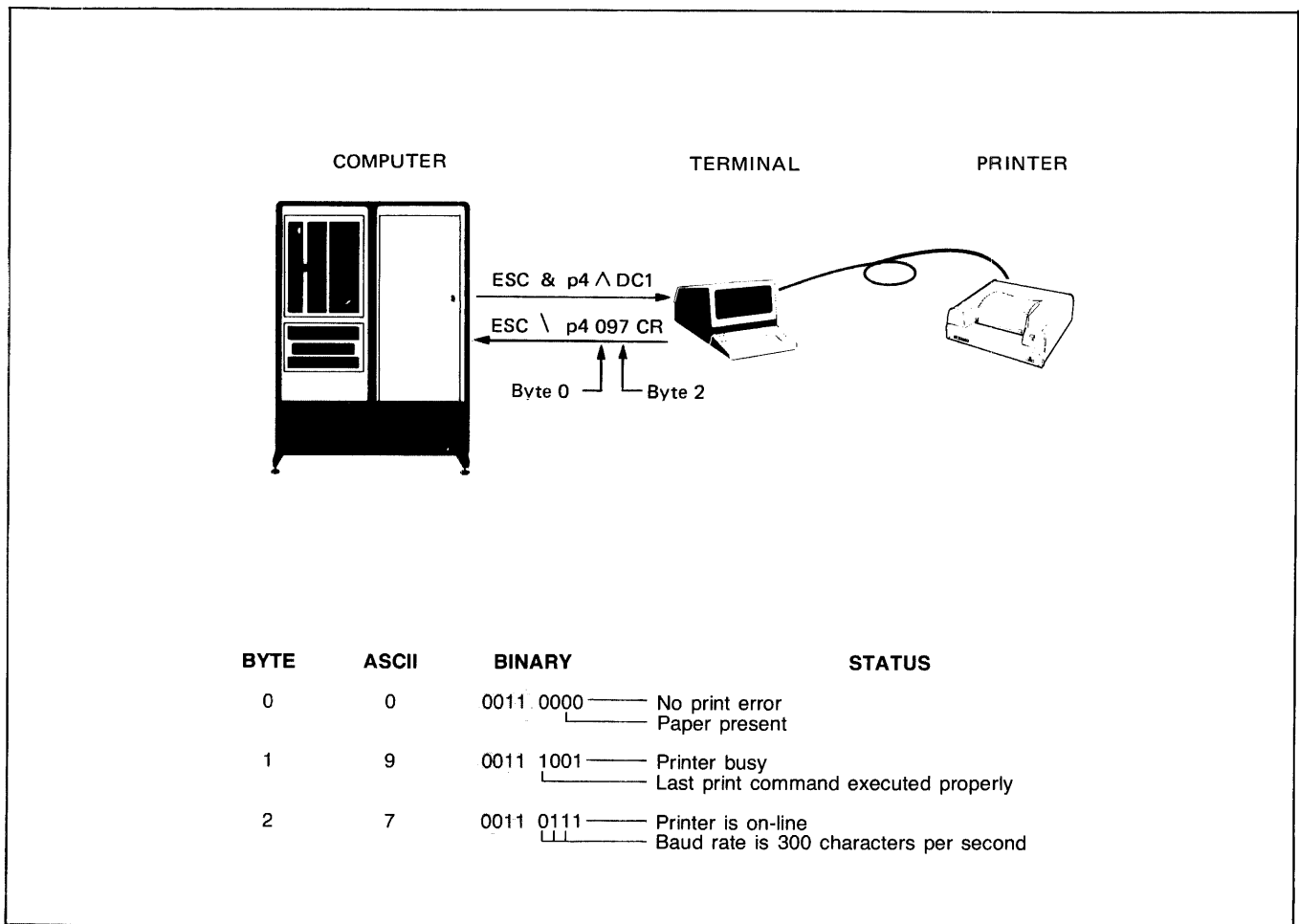


Figure 6-3. Device Status Example

TAPE UNITS

BYTE 0

8	7	6	5	4	3	2	1
0	0	1	1	1/0	1/0	1/0	1/0

End of File
1 = at end of file
(tape positioned after the file mark)
0 = not at end of file

Load Point
1 = at load point
0 = not at load point

Write Error (Write/Backspace/Read Mode only)
1 = error
0 = no error

End of Tape
1 = at end of tape
0 = not at end of tape

BYTE 1

8	7	6	5	4	3	2	1
0	0	1	1	1/0	1/0	1/0	1/0

Command Execution
1 = last command performed
0 = last command aborted

Write Protect
1 = protected
0 = not protected

Tape Busy
1 = busy
0 = not busy

Read Error
1 = error during last read
0 = no error

*A "busy" indication is returned when the terminal is:
conditioning the tape
rewinding the tape
finding a file (keyboard or cartridge tape initiated)
skipping lines (keyboard or cartridge tape initiated)
no tape present

Since the terminal cannot process a status request while performing a normal read or write operation, these functions will not result in a "busy" indication.

BYTE 2

8	7	6	5	4	3	2	1
0	0	1	1	1/0	1/0	1/0	1/0

Soft Error (read/write error-recovered)
1 = yes
0 = no

Hard Error (10 read/write failures)
1 = yes
0 = no

Tape Inserted
1 = yes
0 = no

End of Valid Data
1 = yes
0 = no

PRINTERS

BYTE 0

8	7	6	5	4	3	2	1
0	0	1	1	0	0	1/0	1/0

Paper Out (varies with printer)
1 = yes
0 = no

Print Error (varies with printer)
1 = yes
0 = no

BYTE 1

8	7	6	5	4	3	2	1
0	0	1	1	1/0	0	0	1/0

Command Execution
1 = last command performed
0 = last command aborted

Printer Busy
1 = yes
0 = no

BYTE 2

8	7	6	5	4	3	2	1
0	0	1	1	1/0	1/0	1/0	1/0

Printer Baud Rate

Printer Connected
1 = yes
0 = no

rate	bit		
	4	3	2
external	0	0	0
110	0	0	1
150	0	1	0
300	0	1	1
1200	1	0	0
2400	1	0	1
4800	1	1	0
9600	1	1	1

INSTALLATION

SECTION

VII

INTRODUCTION

This section contains installation instructions for the HP 2645A Display Station. Additional requirements for the HP 2641A and HP 2645S Display Stations are described at

the end of this section. Also included are instructions for selecting optional ac operating voltages (115 or 230V), selecting optional operating functions, and installing terminal add-on accessories.



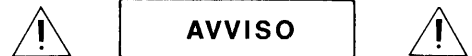
Hazardous voltages are present inside equipment. The procedures contained in this section shall be performed only by qualified service personnel.



Innerhalb des Geräts bestehen gefährliche Spannungen. Die in diesem Abschnitt enthaltenen Arbeiten dürfen nur durch Betriebsfachpersonal durchgeführt werden.



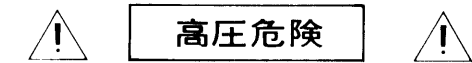
Des tensions dangereuses sont présentes à l'intérieur du matériel. Les opérations décrites dans cette section ne devront être effectuées que par un personnel qualifié.



Pericolo: Alta tensione presente in questa apparecchiatura. Le procedure contenute in questa sezione debbono essere effettuate soltanto da qualificato personale di servizio.



Hay voltaje peligroso en el interior de este equipo. Los procedimientos expuestos en esta sección sólo deberá llevarlos a cabo el personal de servicio calificado.



内部装置に危険な高電圧がきています。この章にある処置や手続に関しては、専門のサービスマンによってのみ行なって下さい

OPENING THE TERMINAL

To gain access to the terminal internal components, open the terminal as follows (also see figure 7-1):

- a. Set mainframe rear panel ~ LINE switch to OFF and disconnect power cord from ~ LINE connector.

NOTE

Mainframe top cover is unlocked by inserting access key supplied with terminal in each of the keyways located on right and left sides of top cover. Inserting keys into keyways unlock top cover. No key rotation is required.

- b. From front of terminal, insert access key into right keyway and unlock right side of terminal by slightly raising right side of top cover. (figure 7-1, A and B).
- c. While maintaining upward pressure to keep right side of terminal unlocked, insert access key into left keyway and raise top cover until both right and left sides of terminal are unlocked. (figure 7-1, C).

- d. Using both hands, carefully swing top cover up until it latches into the half open position. (figure 7-1, D).

NOTE

The half open position provides adequate room for performing most service routines. However, if extensive repairs are to be made or if components contained in the top cover are to be serviced, fully open mainframe in accordance with step e.

CAUTION

Mainframe top hinges are open hinge type. When fully opening terminals do not allow top hinges to slip off hinge pins.

- e. Firmly grasp top cover in one hand and release safety latch (see figure 7-2) by pressing it inboard with other hand. Then, using both hands, swing top cover up and over to a full open position (resting on its top).

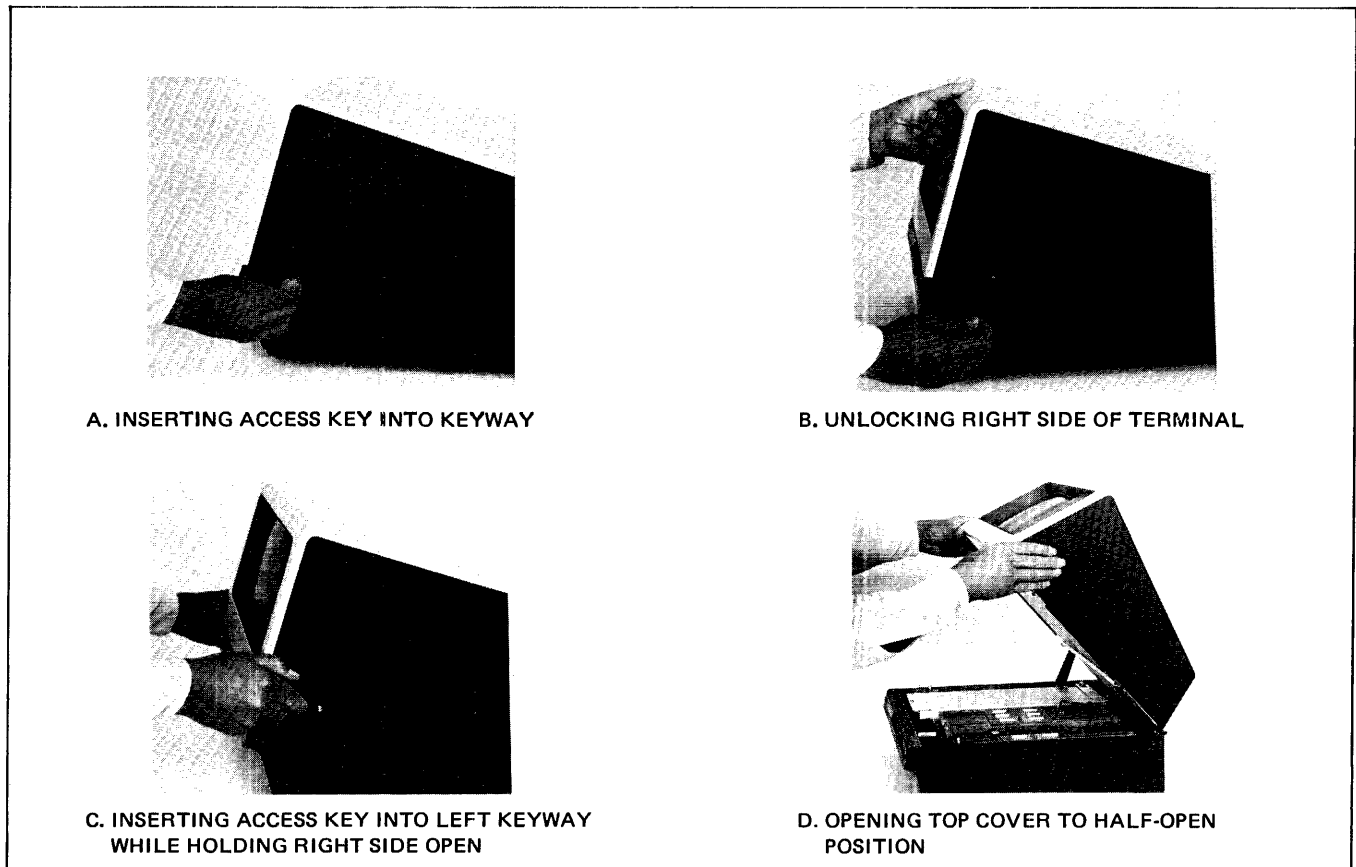


Figure 7-1. Opening the Terminal

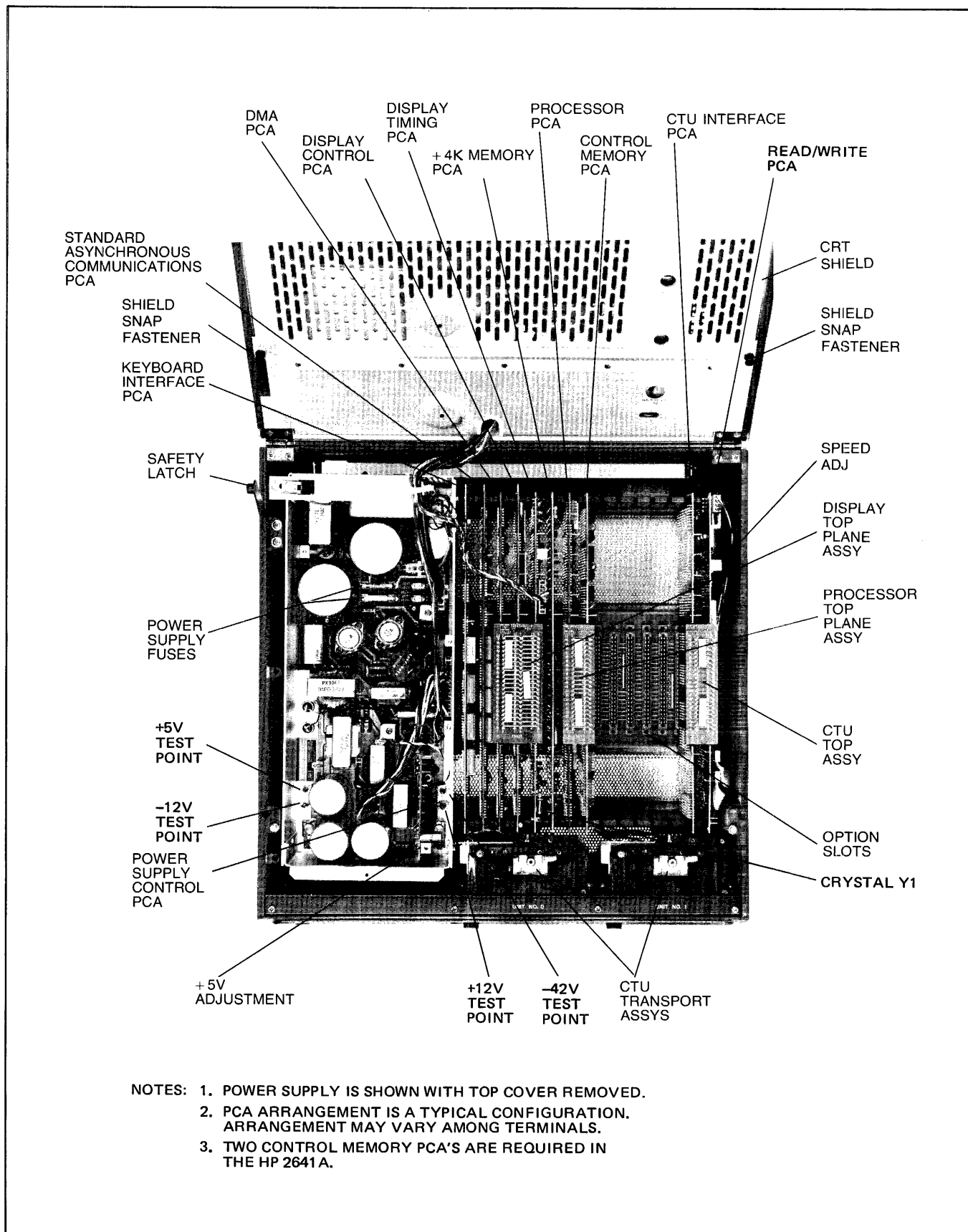


Figure 7-2. Mainframe Bottom Part Locations

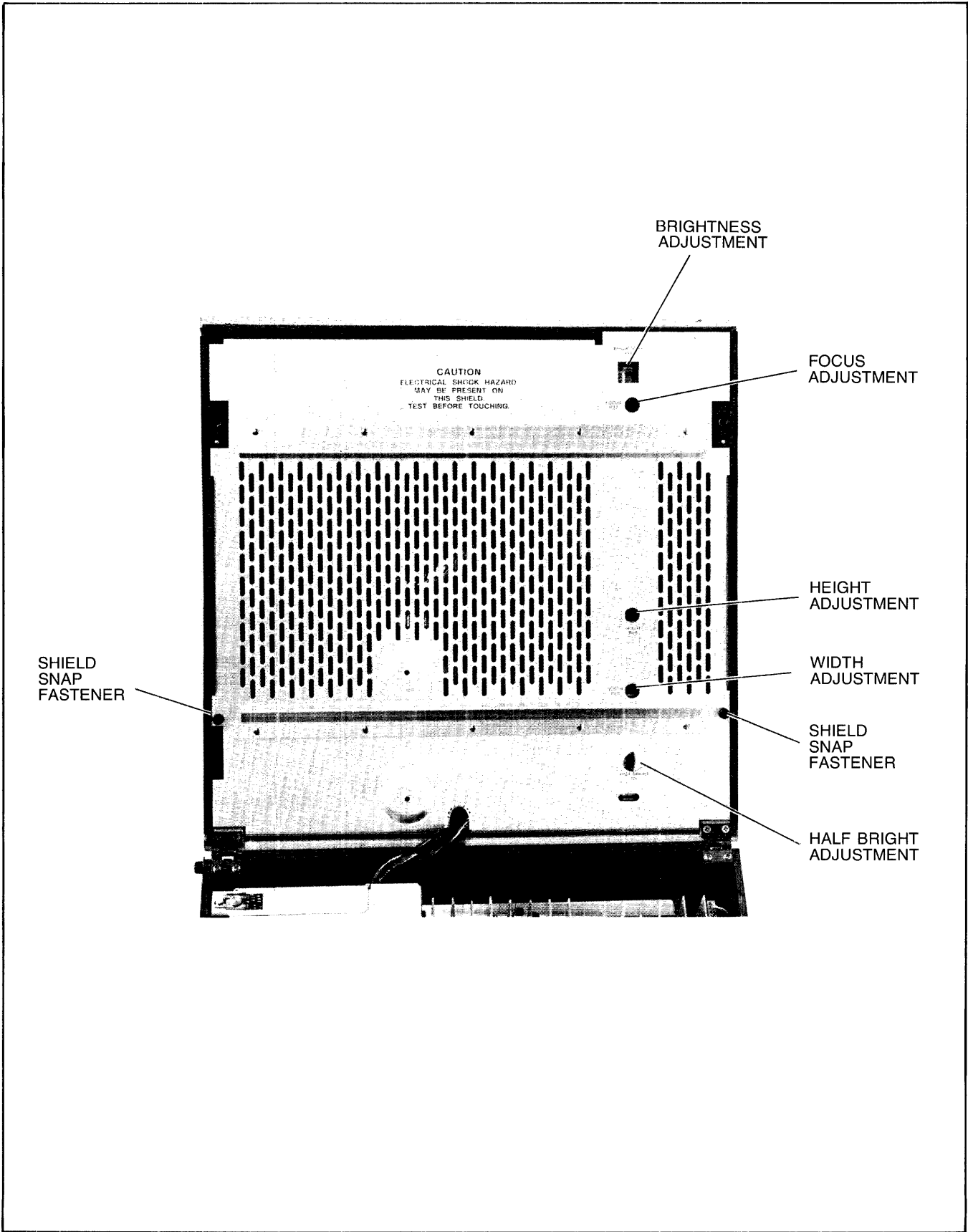


Figure 7-3. Mainframe Top Part Locations

GROUNDING REQUIREMENTS

To protect operating personnel, the National Electrical Manufacturers' Association (NEMA) recommends that the terminal's frame be grounded. The terminal is equipped with a three-conductor power cable which, when connected to an appropriate power receptacle, grounds the frame of the terminal. To preserve this protection feature, do not operate the terminal from an ac power outlet with no ground connection.

SELECTING LINE VOLTAGE

The terminal can be operated from either 115 or 230V, 60 Hz line voltage (230V, 50 Hz optional). When shipped from the factory, the line voltage for which the terminal is configured is stamped on the mainframe rear panel identification label. If it is necessary to change the operating line voltage, ensure that power cord is disconnected and proceed as follows:

1. () Open terminal to its half open position in accordance with "Opening the Terminal" paragraph.

2. () Remove power supply cover by removing the screw at the front of the cover and pulling the cover up and out of the mainframe.
3. () Select the operating voltage by inserting the proper fuses into the appropriate locations shown in figure 7-4. For 115 volts, use a 0.5A, SB, 250V fuse and a 4A, SB, 250V fuse. For 230 volts, use a 0.20A, SB, 250V fuse and a 2A, SB, 250V fuse.
4. () If changing from 60 Hz to 50 Hz operation or vice versa, ensure that crystal Y1 on the Display Timing PCA (figure 7-2) is changed. For 60 Hz operation, use a 21.06 MHz crystal (part no. 0410-0647) and for 50 Hz operation, use a 17.55 MHz crystal (part no. 0410-0646).
5. () Check and, if necessary, adjust power supply in accordance with "Power Supply Adjustment".
6. () Replace power supply cover, and secure in place with the screw.
7. () Firmly grasp mainframe top cover in one hand and release safety latch by pressing it inboard with other hand. Then, using both hands, carefully lower top cover to its closed position.
8. () Perform terminal self-test (refer to "Self-Test").

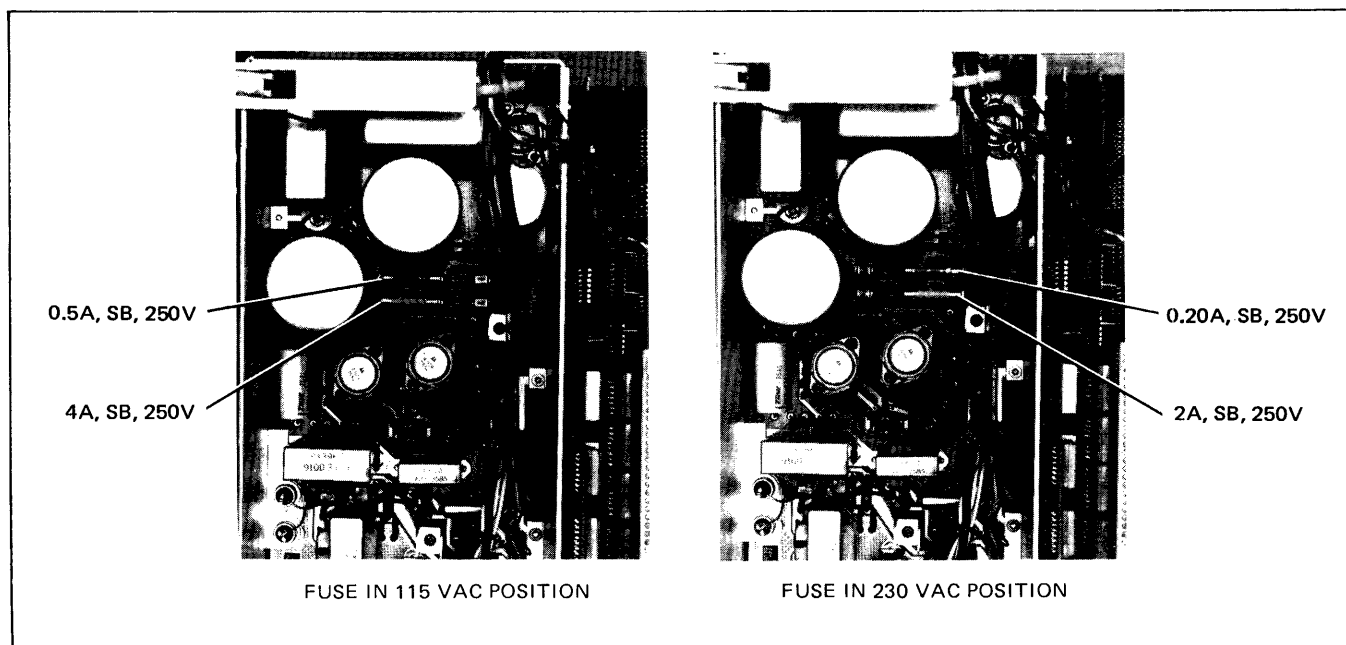


Figure 7-4. Fuse Positions for 115 VAC and 230 VAC Line Voltage

ACCESSORY INSTALLATION PROCEDURES

Instructions for installing add-on accessories to the standard model terminal are contained in the following paragraphs.

NOTE

After installing any accessory, always use the terminal self-test feature (refer to "Self-Test") to ensure proper operation.

64 CHARACTER LOWER CASE ROM

The 64 Character Lower Case ROM, part no. 1816-0613, is used to upgrade standard 64 character set terminals to 128 Roman characters. Do not confuse this with the alternate character sets described in "HP 13231A Display Enhancements" paragraph. Install the ROM as follows:

CAUTION

MOS integrated circuits can be damaged by electrostatic discharge. Use the following precautions:

DO NOT wear clothing subject to static charge buildup, such as wool or synthetic materials.

DO NOT handle MOS circuits in carpeted areas.

DO NOT remove the circuit from its conductive foam pad until you are ready to install it.

AVOID touching the circuit leads. Handle by the plastic package only.

ENSURE that the circuit work surface (table, desk, etc.) and PCA are all at the same ground potential. This can be done by touching the foam pad to the PCA and then touch the foam pad, circuit, and PCA to the work surface.

1. () Open terminal to its half open position (refer to "Opening the Terminal").
2. () Insert connector removal tool under Top Plane Assembly as shown in figure 7-7 and remove Top Plane Assembly by pressing down on connector removal tool handle.
3. () Locate and remove Display Control PCA from Backplane Assembly.
4. () Using figure 7-5 as a guide, locate the 128 CH jumper W1 position and solder in a jumper. (If the board uses a jumper socket or switch, insert a jumper or make the proper setting.)
5. () Locate the vacant lower case ROM socket XU28.
6. () Carefully insert 64 Characters Lower Case ROM in socket XU28 so that ROM pin 1 is at upper right corner of XU28.
7. () Reinstall Display Control PCA in Backplane Assembly connector from which it was removed.
8. () Reinstall Top Plane Assembly on DMA, Display Timing, and Display Control PCA's top connectors.
9. () Firmly grasp top cover in one hand and release safety latch by pressing it inboard with other hand. Then, using both hands, carefully lower top cover to its closed position.

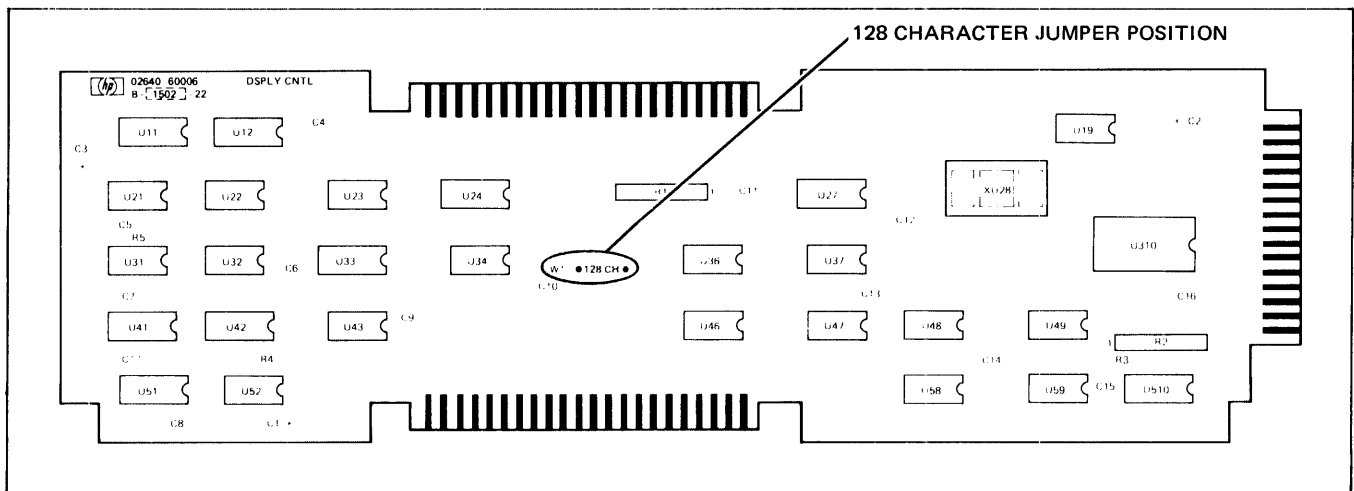


Figure 7-5. Display Control PCA Component Locations

HP 13231A DISPLAY ENHANCEMENTS

These instructions apply to the HP 13231A-201, HP 13231A-202 and HP 13231A-203 accessories as well as the HP 13231A accessory. The HP 13231A accessory consists of a Display Enhancement PCA, part no. 02640-60024; a Top Plane Connector Assembly, part no. 02640-60022; and a Connector Removal Tool, part no. 02640-00029. The HP 13231A-201, -202 and -203 accessories consist of the same three items with the applicable ROM IC's mounted on the Display Enhancement PCA. Install any of these accessories as follows:

The alternate character sets are configured with jumpers located on the upper right corner of the Display Enhancement PCA. There are six jumpers, two for each of the three possible alternate character sets. Jumpers 1 and 2 are for alternate character set 1 (referred to as set A in the User's Manual), jumpers 3 and 4 are for alternate character set 2 (set B in the User's Manual), jumpers 5 and 6 are for alternate character set 3 (set C in the User's Manual).

The first jumper for each set (jumpers 1, 3, and 5) indicates whether the set is composed of 128 (jumper in) or 64 (jumper out) characters. The second jumper for each set (jumpers 2, 4, and 6) indicates whether the character set data is in alphanumeric (jumper in) or microvector (jumper out) format. A detailed description of data formats for alternate character sets is given in the application note: *2640 Series Character Set Generation* (part number 13245-90001).

When using the three standard alternate character sets (Math Set, Line Set and Large Character Set) the jumpers would normally be configured as follows:

Math Set (placed in the first socket of set 1)

Jumper 1 = Out, since only 64 characters are used.

Jumper 2 = In, since character data is in alphanumeric format.

Line Set (placed in the first socket of set 2)

Jumper 3 = Out, since only 64 characters are used.

Jumper 4 = Out, since character data is in microvector form.

Large Character Set (placed in the first select of set 3)

Jumper 5 = Out, since only 64 characters are used.

Jumper 6 = Out, since character data is in microvector form.

Note that the Math Set has been shown as alternate character set 1 (A in the User's Manual), the Line Set as alternate 2 (B in the User's Manual), and the Large Character Set as alternate 3 (C in the User's Manual). They could have been configured as any combination of the three possible alternate sets. There is no requirement that the sets be configured in any order.

NOTE

Do not confuse the 128/64 character jumpers for *alternate character sets* with the 128 character jumper for the *standard character set* discussed in "64 Character Lower Case Rom."

EFFECT OF IMPROPER JUMPER PLACEMENT.

128 Characters Strapped for 64. When a 128 character set is used and is jumpered for 64 characters, only the first 64 characters in the set will be accessed. This will cause the "q" character for example to access the same display character as the "Q" character.

64 Characters Strapped for 128. Any attempt to access one of the lower case 64 characters ("a", "q", etc.) will result in a blank being displayed.

Alphanumeric Data Strapped as Microvector. Alphanumeric data strapped as microvector will normally result in characters that are skewed or fuzzy.

Microvector Data Strapped as Alphanumeric. Microvector data strapped as alphanumeric will display blanks for the microvector characters.

INSTALLATION PROCEDURE

1. () Using figure 7-6 and table 7-1 as a guide, check that Display Enhancement PCA jumpers are arranged correctly for the ROM character set configuration. If there are no alternate character set ROM's installed (HP 13231A), all jumpers should be in the jumper socket.
2. () Open terminal to its half open position (refer to "Opening the Terminal").
3. () Insert connector removal tool under Top Plane Assembly as shown in figure 7-7.
4. () Remove Top Plane Assembly by pressing down on connector removal tool handle. Retain Top Plane Assembly for possible future use.

Table 7-1. Display Enhancement PCA Jumper Protocol

ALTERNATE SET	128/64 (JUMPER IN/JUMPER OUT) CHARACTERS	ALPHANUMERIC/MICROVECTOR (JUMPER IN/JUMPER OUT) CHARACTER DATA
A	JUMPER 1	JUMPER 2
B	JUMPER 3	JUMPER 4
C	JUMPER 5	JUMPER 6

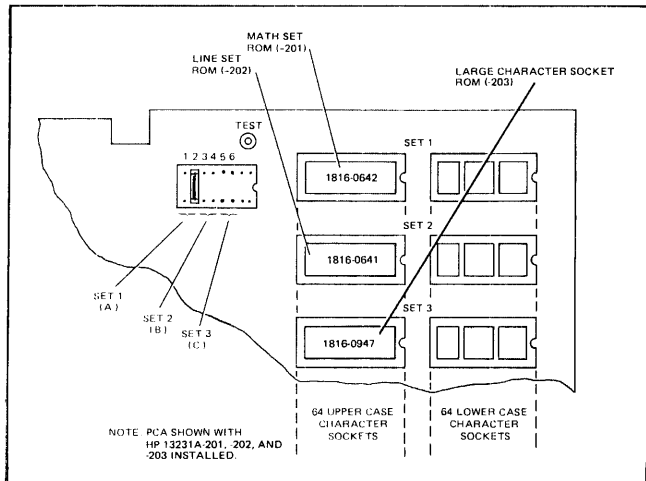


Figure 7-6. Display Enhancement PCA Jumper and ROM Socket Locations

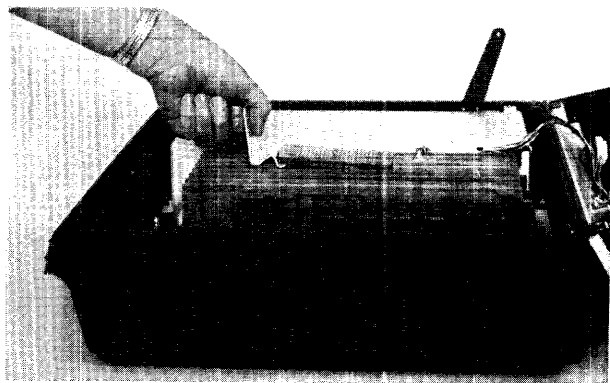


Figure 7-7. Top Plane Assembly Removal

data communications PCA's should be installed in one of the first three Backplane Assembly connectors closest to the power supply.

The Display Enhancement, DMA, Display Control, and Display Timing PCA's must always be installed as a group in adjacent connectors. No Backplane Assembly connectors can be left vacant between any PCA's. In addition, the Processor PCA must be installed adjacent to the display PCA's described previously.

- 5. () If necessary, rearrange PCA's in Backplane Assembly so that an unused connector is available for the Display Enhancement PCA adjacent to the Display Memory Access (DMA), Display Control, and Display Timing PCA's.

NOTE

PCA arrangement can be in any configuration with the following exceptions. The Keyboard Interface and

- 6. () Install Display Enhancement PCA in Backplane Assembly connector.
- 7. () Install Top Plane Connector Assembly, part no. 02640-60022 on Display Enhancement, DMA, Display Control, and Display Timing PCA connectors.
- 8. () Check and, if necessary, adjust power supply (refer to "Power Supply Adjustment").
- 9. () Depress TEST key and observe last line of test pattern for correct display enhancements. If enhancements are correct skip to step 11. If adjustment is necessary, perform step 10.
- 10. () Perform brightness, half bright, focus, and field adjustments in accordance with the *HP 2641A/2645A/S Display Station Service Manual*, part no. 02645-90003.
- 11. () Firmly grasp mainframe top cover in one hand and release safety latch by pressing it inboard with other hand. Then, using both hands, carefully lower top cover to its closed position.

HP 13232 CABLE ASSEMBLIES

The HP 13232 cable assemblies provide interface connections between the terminal and modems, printers, and computers. Table 7-2 below lists the particulars of each cable.

Table 7-2. 13232 Cable Assemblies

CABLE	FUNCTION	CONNECTORS			LENGTH	HOOKUP
		A	B	C		
13232A	Connects data communications interface PCA to modem 103/202. (Cable part no. 02640-60043.)	RS232 (male)	Hood	—	4.57 Metres 15 feet	
13232B	Connects 12531/12880 teleprinter interface PCA to terminal. (Cable part no. 02640-60058.)	Hood	Hood	—	15.25 Metres 50 feet	
13232C	Connects data communications interface PCA to RS232 connector. (Cable part no. 02640-60059.)	RS232C (female)	Hood	—	1.52 Metres 5 feet	
13232F	Provides current loop connections for 13260B data communications interface. (Cable part no. 02640-60097.)	4 terminal lugs	Hood	—	1.52 Metres 5 feet	
13232G	Connects 13250A Serial Printer Interface to RS232 compatible printers. (Cable part no. 02640-60098.)	RS232C (male)	Hood	—	4.57 Metres 15 feet	
13232H	Same as 13232G. (Cable part no. 02640-60099.)	RS232C (female)	Hood	—	4.57 Metres 15 feet	
13232J	Connects 13238A Duplex Register PCA to 9871A Printer. (Cable part no. 02640-60116.)	9871A printer (female)	Hood	—	1.83 Metres 6 feet	
13232K	Connects 13254A Video Interface PCA to Tektronix 4632/7 Video Copier. (Cable part no. 02640-60120.)	RS232 (male)	Hood	—	4.57 Metres 15 feet	
13232L	Connects 13254A Video Interface PCA to Conrac Monitor. (Cable part no. 02640-60121.)	BNC	Hood	—	7.61 Metres 2.5 feet	
13232N	Connects data communications interface PCA to modem. (Cable part no. 02640-60131.)	RS232C (male)	Hood	—	4.57 Metres 15 feet	
13232P	Connects 13260C or 13260D data communication interface PCA to modem in multipoint configurations. (Cable part no. 02640-60132.)	RS232C (male)	Hood	Multipoint (female)	4.57 Metres 15 feet (each leg)	
13232Q	Connects 13260C or 13260D data communications interface PCA to other terminals in downstream multipoint configuration. (Cable part no. 02640-60133.)	Multipoint (male)	Hood	Multipoint (female)	4.57 Metres 15 feet (each leg)	

Table 7-2. 13232 Cable Assemblies (Continued)

CABLE	FUNCTION	CONNECTORS			LENGTH	HOOKUP
		A	B	C		
13232R	Provides 100-foot extension to 13232P, Q, T, multipoint cables. (Cable part no. 02640-60134.)	Multipoint (male)	Multipoint (female)	Multipoint (female)	30.5 Metres 100 feet	
13232S	Connects 13238A Duplex Register PCA to 9866A/B Printer. (Cable part no. 02640-60135.)	9866 printer (male)	Hood	—	1.83 Metres 6 feet	
13232T	Provides power-down protection for a terminal in multipoint configuration. (Cable part no. 02640-60151.)	Multipoint (male)	Hood	Multipoint (female)	4.57 Metres 15 feet (each leg)	
13232U	Provides direct connection to a computer by replacing the modem connections. (Cable part no. 5060-2403.)	RS232C (female)	RS232C (female)	—	1.52 Metres 5 feet	

HP 13234A (4K) TERMINAL MEMORY MODULE

Install the HP 13234A (+ 4K) memory accessory as follows:

1. () Open terminal to its half open position (refer to page "Opening the Terminal").
2. () Locate and ensure that the Control Memory PCA, part no. 02640-60136, has all jumpers installed. (See figures 7-2 and 7-8.) For HP 2641A, refer to figure 7-36 for second Control Memory PCA jumper configuration.
3. () Using figure 7-9 as a guide, locate memory jumpers on 4K Memory PCA.
4. () Using figures 7-10 and 7-11 as guides, arrange PCA starting address jumpers to select appropriate memory starting address for the size memory being configured. For example: to configure an 8K memory, remove all jumpers from one of the 4K Memory PCAs, and remove all but the 4K jumper from the other 4K Memory PCA.

NOTE

If a full 16K of memory is to be configured, the 4K block of data comm buffer is located outside the zero to 12K of display memory space.

5. () Install memory PCA's in any vacant Backplane Assembly connectors ensuring that no connectors are left vacant between any PCA's other than the two cartridge tape unit PCA's (if installed).
6. () Check and, if necessary, adjust power supply (refer to "Power Supply Adjustment").
7. () Firmly grasp mainframe top cover in one hand and release safety latch by pressing it inboard with other hand. Then, using both hands, carefully lower top cover to its closed position.

HP 13236B CARTRIDGE TAPE UNIT

The HP 13236B Cartridge Tape Unit is provided to upgrade the terminals to include mass storage capabilities. This accessory consists of two cartridge tape (CTU) Transport Assemblies, two Tape Cartridges, a CTU Interface PCA, a Read/Write PCA, a CTU Top Plane Assembly, a Motor Cable Assembly, a front bezel and required attaching hardware. Installation procedures are contained in the HP 13236A/B Cartridge Tape Unit Accessory Manual, part no. 13236-90001.

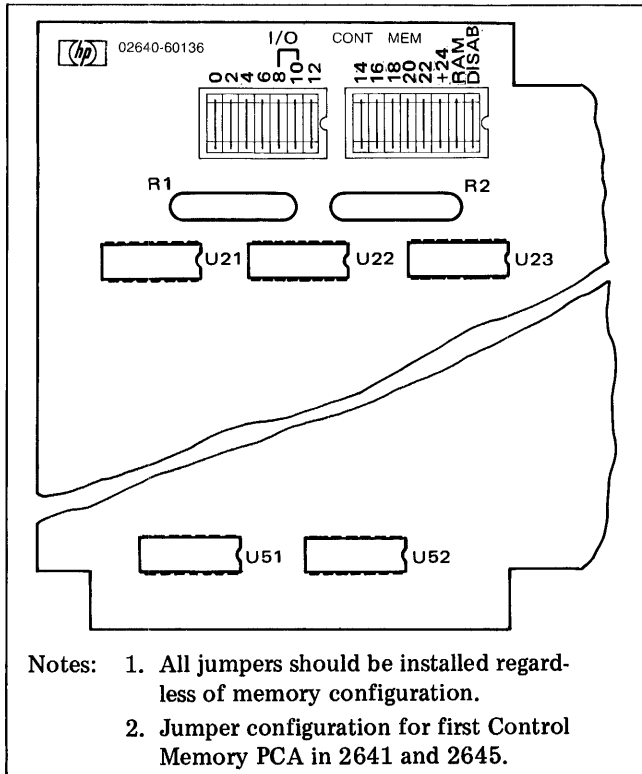


Figure 7-8. Control Memory PCA Jumper Socket Location

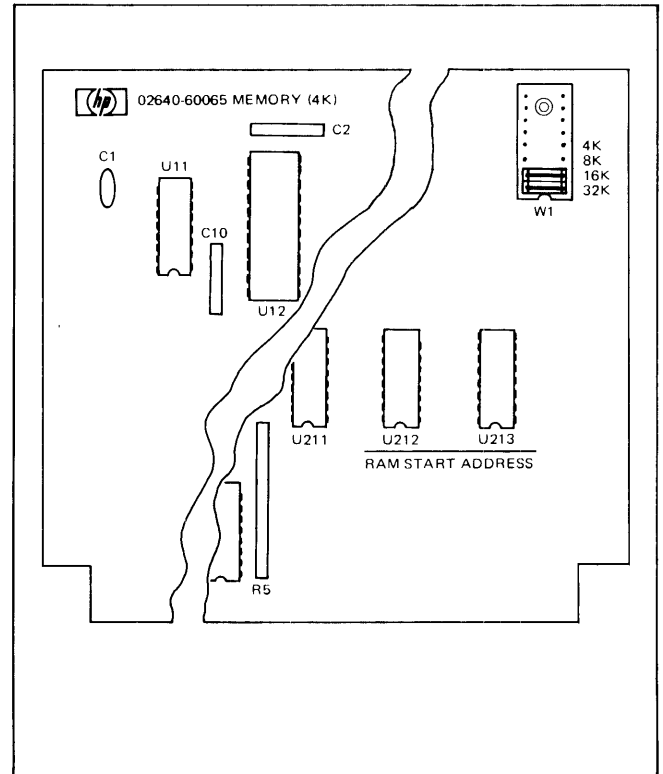


Figure 7-9. 4K Memory PCA Jumper Socket Location

HP 13238A TERMINAL DUPLEX REGISTER

To install the HP 13238A accessory, perform all the following steps except steps 4 and 5.

1. () Open terminal to its half open position (refer to "Opening the Terminal").
2. () Configure jumpers in Terminal Duplex Register PCA jumper sockets as shown in figure 7-12.
3. () Install Terminal Duplex Register PCA in first vacant Backplane Assembly connector adjacent to existing PCA's.

NOTE

To ensure proper terminal operation, all PCA's must be installed in adjacent Backplane Assembly connectors. There should never be vacant connectors between PCA's except for the two CTU PCA's in option 007 (Read/Write PCA and CTU Interface PCA) which can be separated from the others.

4. () Open mainframe rear door by twisting two lock extrusions.

5. () Holding Terminal Duplex Register PCA firmly in place, carefully connect hood connector of the cable assembly, supplied with the printer subsystem, to PCA connector P2.

NOTE

The hood connector and PCA connector P2 are identically keyed to prevent inadvertent erroneous connections. Connecting the two together requires minimal hand pressure. If excessive resistance is encountered, an incorrect connection is being attempted.

For printer interfacing information refer to the *HP 9866A/B Printer Operator's Manual*, part no. 09866-90901, or the *HP 13349A Printer Subsystem Operating Manual*, part no. 13349-90901.

6. () Check and, if necessary, adjust power supply (refer to "Power Supply Adjustment").
7. () Firmly grasp mainframe top cover in one hand and release safety latch by pressing it inboard with other hand. Then, using both hands, carefully lower top cover to its closed position.

Installation

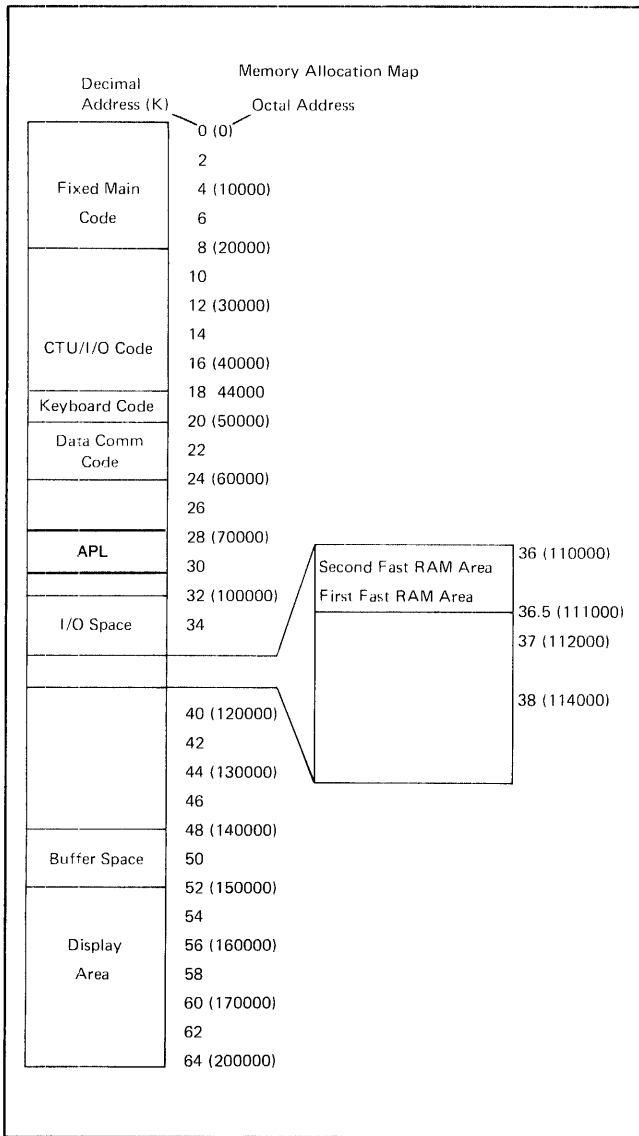
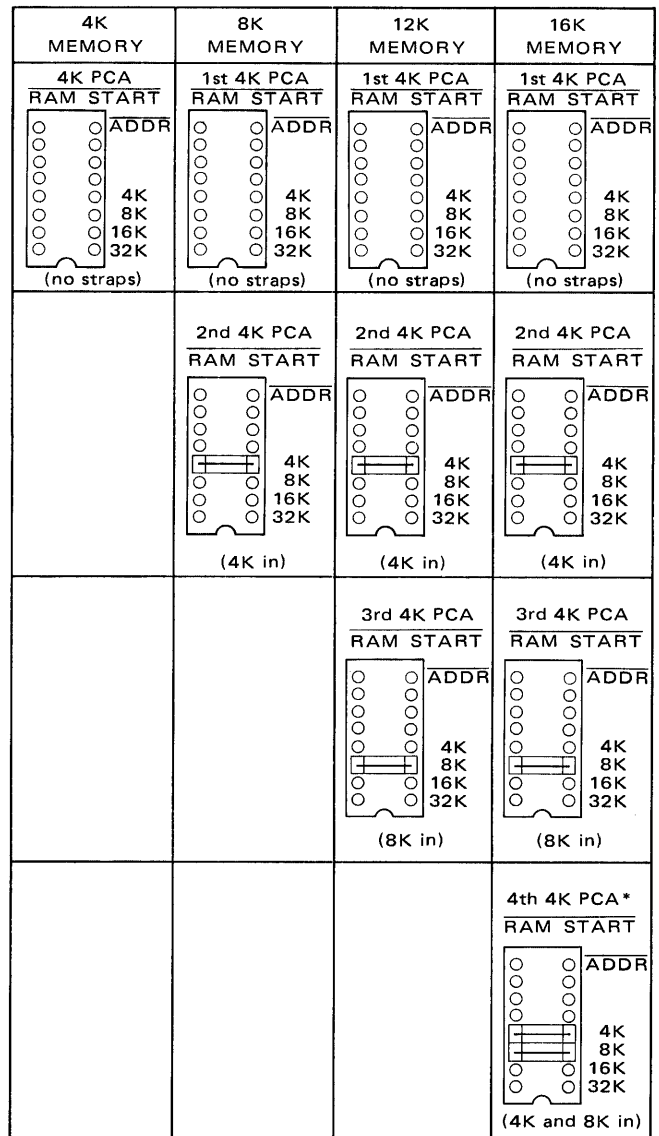


Figure 7-10. Typical Memory Map



*Used for data comm buffer only.

Figure 7-11. Configuring 4K Memory PCA Jumpers

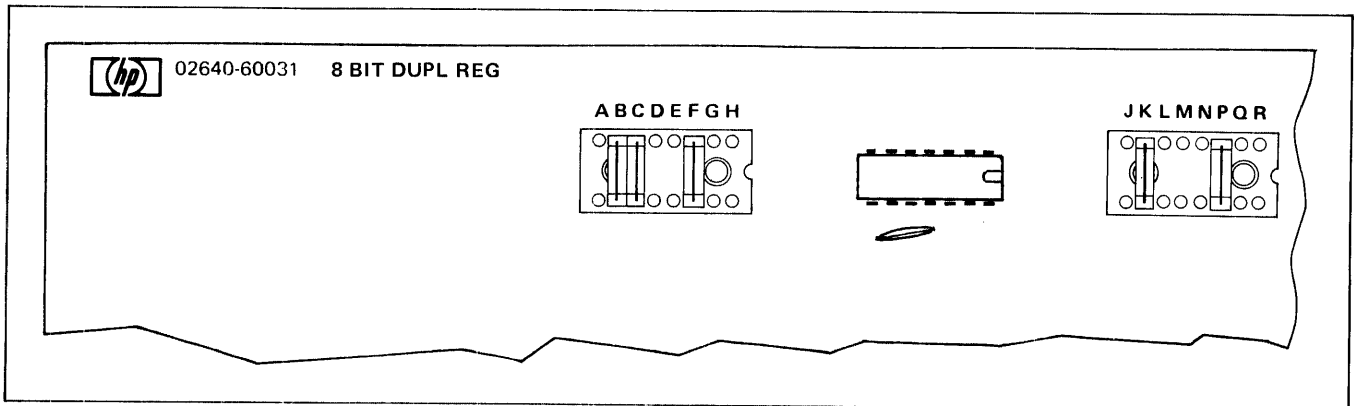


Figure 7-12. Terminal Duplex Register PCA Jumper Configuration

HP 13245A CHARACTER SET GENERATION KIT

The Character Set Generation Kit Accessory consists of a PROM Character PCA, part no. 02640-60053 and a Connector Assembly, part no. 02640-60070. Install the HP 13245A accessory as follows:

1. () Open terminal to its half open position (refer to "Opening the Terminal").
2. () Rearrange PCA's in the Backplane Assembly so that an unused connector is available for the PROM Character PCA adjacent to either the Display Control PCA or Display Enhancement PCA depending on the character set(s) to be replaced. If the base character set is to be replaced, vacate a connector adjacent to the Display Control PCA. If an alternate character set(s) is to be replaced, vacate a connector adjacent to the Display Enhancement PCA.

NOTE

PCA arrangement can be in any configuration with the following exceptions. The Keyboard Interface and data communications PCA's should always be installed in one of the first three Backplane Assembly connectors closest to the power supply. The Display Enhancement, DMA, Display Control, and Display Timing PCA's must always be installed as a group in adjacent connectors to accommodate the Top Plane Connector Assembly. The CTU Interface and Read/Write PCA's (option 007) must always be installed in adjacent connectors. No Backplane Assembly connectors can be left vacant between any PCA's except for the two CTU PCA's which can be separated from the others.

3. () Install PROM Character PCA in vacated Backplane Assembly connector.

NOTE

The base or alternate character set ROM(s) to be replaced by the user generated PROM set(s) must be removed from the applicable PCA in accordance with the instructions contained in the *Character Set Generation Kit Application Note*, part no. 13245-90001.

4. () When connected to the Display Enhancement PCA, the PROM Character PCA character sets 1 and 2 replace the Display Enhancement PCA character sets 1 and 2 respectively. If an alternate set(s) is to be replaced, first determine if the user generated PROM set(s) is alphanumeric or

microvector. Then, using table 7-1 and figure 7-6 as a guide, correctly arrange Display Enhancement PCA jumpers 2 and 4 for the PROM character set type(s). (Jumpers 1 and 3 can either be removed or left installed.)

5. () Attach Connector Assembly, part no. 02640-60070 between the two interface connectors (P2) on the PROM Character PCA and Display Control PCA or Display Enhancement PCA.
6. () Check and, if necessary, adjust power supply (refer to "Power Supply Adjustment").
7. () Firmly grasp mainframe top cover in one hand and release safety latch by pressing it inboard with other hand. Then, using both hands, carefully lower top cover to its closed position.

HP 13246A/B PRINTER SUBSYSTEM (9866)

This accessory consists of a Terminal Duplex Register PCA, part no. 02640-60031; a 13232S Cable Assembly, part no. 02640-60135; and an HP 9866A or B Printer. To install this accessory, first perform the HP 13238A Terminal Duplex Register installation instructions steps 1 through 7. After the PCA and cable assembly have been installed, install the printer in accordance with the instructions contained in the *HP 9866A/B Printer Operator's Manual*, part no. 09866-90901.

HP 13250B SERIAL PRINTER INTERFACE

The HP 13250B provides an RS232C interface to serial printers. You can configure the 13250B to be compatible with many RS232 serial printers requiring handshake or full-character protocol. For details on configuring and installing the interface, refer to the HP 13250 accessory manual, part no. 02640-90042.

HP 13260A,B,C,D DATA COMMUNICATIONS ACCESSORIES

The HP 13260A,B,C,D Data Communications Accessories provide various types of data communications from teletypewriter compatible data communications to asynchronous or synchronous multipoint polling. (Refer to Section V for details of these accessories.) Only one data communications interface may be installed in the terminal at any time. Each accessory consists of the items listed in table 7-3.

CAUTION

MOS integrated circuits can be damaged by electrostatic discharge. Use the following precautions:

Table 7-3. Contents of 13260 Data Communications Accessories

ITEM	PART NUMBERS			
	13260A	13260B	13260C	13260D
Interface Printed Circuit Assembly	02640-60086	02640-60143	02640-60106	02640-60107
ROM IC's	1818-0213	1818-0213	1818-0214 (std only) 1818-0261 (opt 001 only) 1818-0288	1818-0214 (std only) 1818-0261 (opt 001 only) 1818-0288
Keyboard Overlay	02644-00002	02644-00002	02645-00003	02645-00003
Baudrate Label	7120-5486	7120-5486	7120-5485	7120-5485
Test Connector Assembly	02645-60002	02645-60003	02645-60002 02645-60004	02645-60002 02645-60004
Ground Cable Assembly			02640-60083	02640-60083

DO NOT wear clothing subject to static charge buildup, such as wool or synthetic materials.

DO NOT handle MOS circuits in carpeted areas.

DO NOT remove the circuit from its conductive foam pad until you are ready to install it.

AVOID touching the circuit leads. Handle by the plastic package only.

ENSURE that the circuit, work surface (table, desk, etc.) and PCA are all at the same ground potential. This can be done by touching the foam pad to the PCA and then touch the foam pad, circuit, and PCA to the work surface.

1. () Perform complete terminal SELF-TEST (refer to "Self-Test") to verify proper terminal operation before installing the accessory.
2. () Turn off ~ LINE switch at rear of terminal and disconnect power cord.
3. () Open terminal as described in "Opening the Terminal."
4. () Locate the Control Memory PCA, part no. 02640-60136 (see figure 7-2).
5. () Insert connector removal tool under Top Plane Assembly as shown in figure 7-7, and remove Top Plane Assembly by pressing down on connector removal tool handle.

6. () Remove the Control Memory PCA.
7. () Remove IC's, if present, from DATA COMM sockets 20 and 22 of Control Memory PCA (see figure 7-13).
8. () Carefully unpack and inventory 13260 accessory parts per table 7-3 above.
9. () Carefully insert ROM(s) contained in accessory package into DATA COMM socket(s) so that ROM pin 1 is at upper right corner of socket (see figure 7-13).
10. () Reinstall Control Memory PCA into backplane assembly connector from which it was removed.
11. () Reinstall Top Plane Assembly on Processor and Control Memory PCA's top connectors.
12. () Configure the 13260B, C, or D Interface PCA's for your particular application by setting the switches on the PCA. For additional options, refer to "Selecting Optional Operating Functions."
13. () Install the Interface PCA in the first vacant backplane assembly connector adjacent to existing PCA's. For 13260C/D installation, connect ground cable assembly (part no. 02640-60043) between power supply chassis ground and PCA ground connector lug.

NOTE

To ensure proper terminal operation, all PCA's must be installed in adjacent Backplane Assembly connectors. There

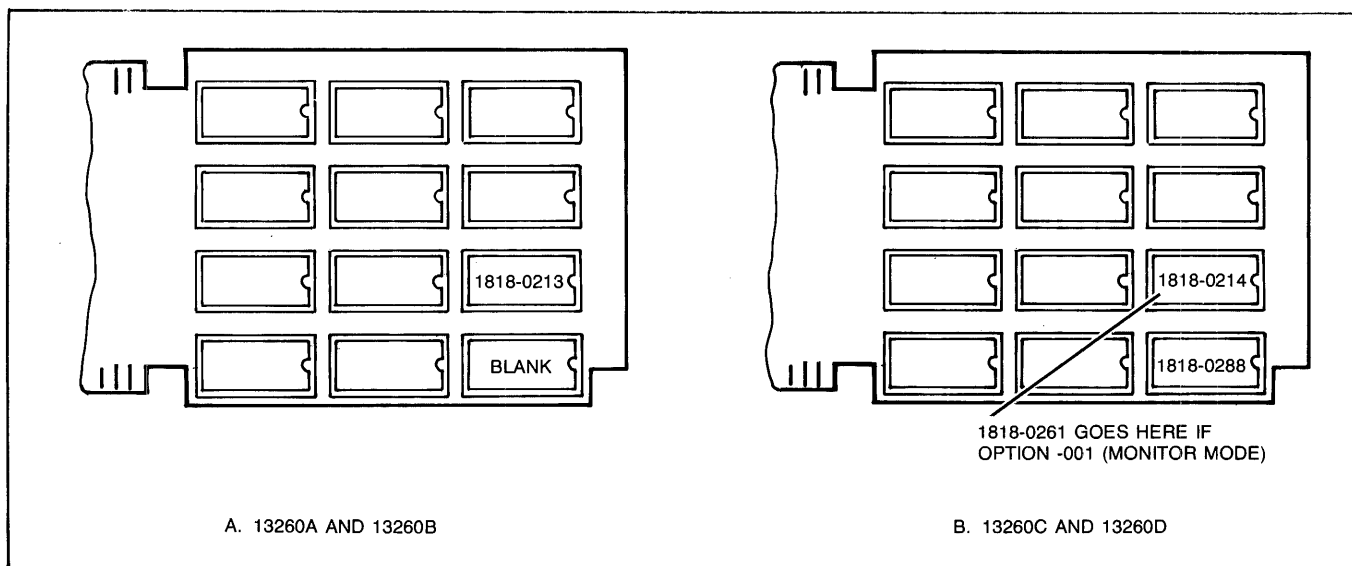


Figure 7-13. Control Memory PCA Data Comm Firmware IC Locations

should never be vacant connectors between PCA's except for the two CTU PCA's (Read/Write PCA and CTU Interface PCA and datacomm PCA's) in option 007 which can be separated from the others.

14. () Open mainframe rear door by twisting the two lock extrusions.
15. () Holding the communications interface PCA firmly in place, carefully connect Test Connector Assembly supplied with the accessory to PCA, and perform the DATA COMM SELF-TEST to verify proper operation of the PCA (refer to "Data Communications Self-Test"). After self test is performed, remove the Test Connector Assembly.
16. () Holding the communications interface PCA firmly in place, carefully connect hood connector of a 13232C, F,N,P,Q, or T Cable Assembly to PCA. For cabling information, refer to "HP 13232 Cable Assemblies" and "Data Communications Cabling."

NOTE

The hood connector and PCA connector P2 are identically keyed to prevent inadvertent erroneous connections. Connecting the two together requires minimal hand pressure. If excessive resistance is encountered, an incorrect connection is being attempted.

17. () Install baudrate switch overlay and keyboard overlay as shown in figure 7-14.

18. () Firmly grasp top cover in one hand, and release safety catch by pressing it inboard with your other hand. Then, using both hands, carefully lower top cover to its closed position.

13261A DEVICE SUPPORT FIRMWARE

The 13261A Device Support Firmware provides the firmware required to operate peripheral devices from the terminal (such as printers, hard copy unit, etc.). This firmware is not required if option 007, the cartridge tape units, is installed.

The accessory consists of four ROM IC's (part nos. 1818-0208, 1818-0209, 1818-0210, and 1818-0211) mounted on a conductive foam pad. The pad prevents the ROM IC's from being damaged by electrostatic discharge.

CAUTION

MOS integrated circuits can be damaged by electrostatic discharge. Use the following precautions:

DO NOT wear clothing subject to static charge buildup, such as wool or synthetic materials.

DO NOT handle MOS circuits in carpeted areas.

DO NOT remove the circuit from its conductive foam pad until you are ready to install it.

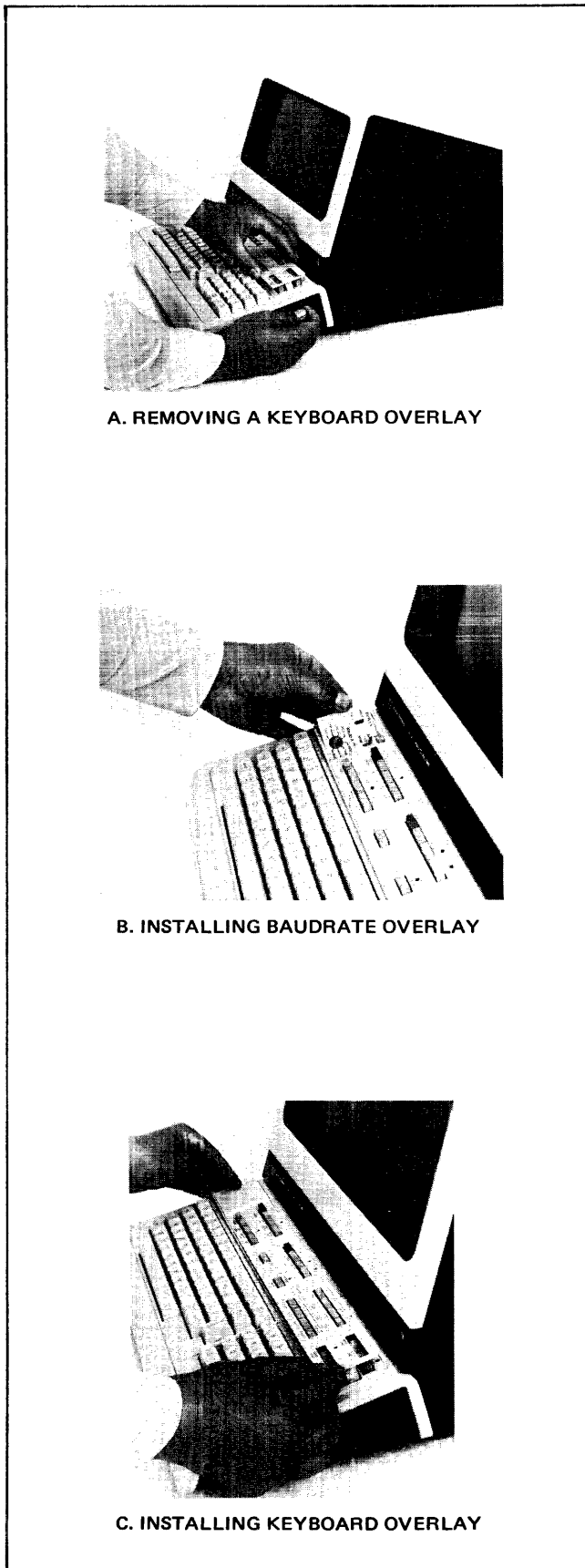


Figure 7-14. Installing Keyboard Overlays

AVOID touching the circuit leads. Handle by the plastic package only.

ENSURE that the circuit, work surface (table, desk, etc.) and PCA are all at the same ground potential. This can be done by touching the foam pad to the PCA and then touch the foam pad, circuit, and PCA to the work surface.

1. () Perform complete terminal SELF-TEST (refer to "Self-Test") to verify proper terminal operation before installing the accessory.
2. () Turn off AC POWER switch at rear of terminal and disconnect power cord.
3. () Open terminal (refer to "Opening the Terminal").
4. () Locate the Control Memory PCA, part no. 02640-60136 (see figure 7-2).
5. () Insert connector removal tool under Top Plane Assembly as shown in figure 7-7.
6. () Remove the Control Memory PCA.
7. () Carefully unpack and inventory 13261A accessories parts.
8. () Carefully insert the appropriate ROM contained in accessory package into ROM socket 10 through 16 that ROM pin 1 is at upper right corner of each socket (see figure 7-15).
9. () Reinstall Control Memory PCA into backplane assembly connector from which it was removed.
10. () Reinstall Top Plane Assembly on Processor and Control Memory PCAs' top connectors.
11. () Perform terminal SELF-TEST to verify proper terminal operations after installing accessory.

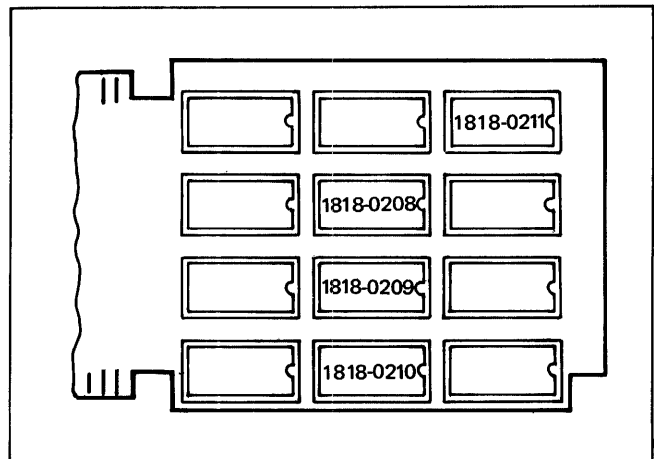
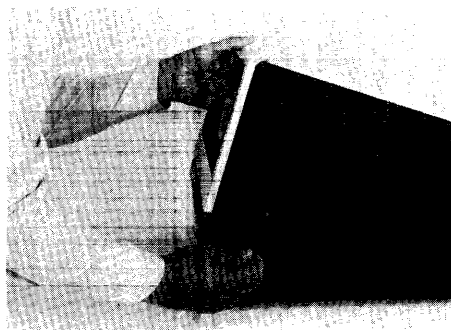


Figure 7-15. 13261A Device Support Firmware IC Locations on Control Memory PCA

HP 13349A PRINTER SUBSYSTEM (9871)

This accessory consists of a Terminal Duplex Register PCA, part no. 02640-60031; an Interface Cable Assembly, part no. 02640-60116; and an HP 9871A Printer. To install this accessory, first perform the HP 13238A Terminal Duplex Register installation instructions steps 1 through 7. After the PCA and cable assembly have been installed, install the printer in accordance with the instructions contained in the *HP 13349A Printer Subsystem Operating Manual*, part no. 13349-90901.



POWER SUPPLY ADJUSTMENT

After installing or removing accessories, you should adjust the +5 volt output of the terminal's power supply. Only this voltage need be adjusted because the +5 volts provides reference for the other supply voltages. The adjustment requires a 20,000 ohms/volt voltmeter.

To adjust the +5V, proceed as follows:

1. () Open the terminal, and remove power supply cover.
2. () Turn on ac power to terminal, and ensure that neither cartridge tape transport motor is running (if installed).
3. () Check the voltages at the following points with the multimeter. (See figure 7-2.)

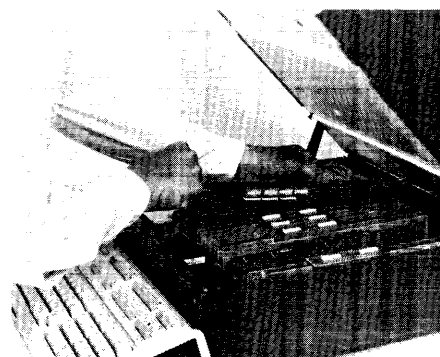
TEST POINT	VOLTAGE TOLERANCE
+5V diode	+ 4.85V to + 5.25V
-42V diode	- 40V to - 46V
+12V diode	+ 11.8V to + 12.6V
-12V diode	- 11.8V to - 12.6V

4. () Adjust +5 volt potentiometer until all voltages are within tolerance.
5. () When all voltages are within tolerance, turn off power, disconnect multimeter, and replace power supply cover.

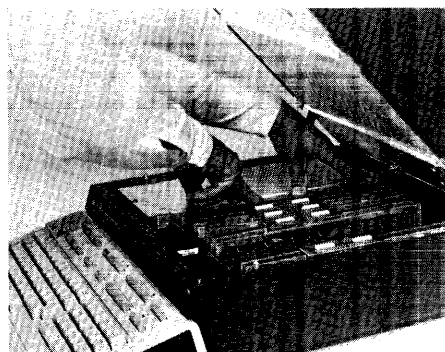
SELECTING OPTIONAL OPERATING FUNCTIONS

The terminal is equipped with jumper and switch selectable options that can be used to alter some of its operating functions (see figure 7-16). These options and their effects on terminal operation are discussed in tables 7-4 through 7-8. To select an operating function, proceed as follows:

1. () Open the terminal to its half open position (refer to "Opening the Terminal").

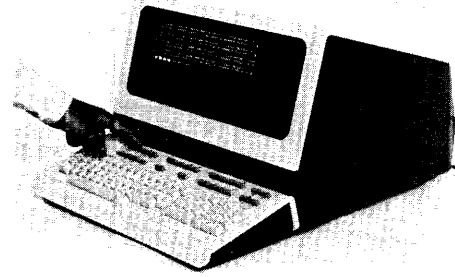
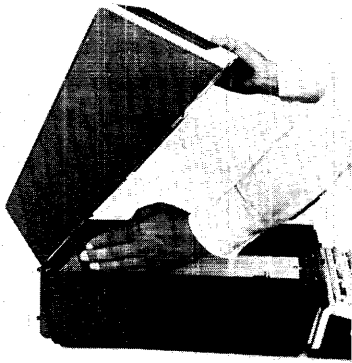


2. () Locate the particular PCA, and remove the cable hood connector from the PCA. Then, remove the PCA from the Backplane Assembly connector.
3. () Using figure 7-17, 7-18, 7-19, or 7-20 (as applicable) and table 7-4, 7-5, 7-6, 7-7 or 7-8 (as applicable), select the desired operating functions, and set the switches to the appropriate positions. (More information on configuration is given in Section V.)



4. () Reinstall the PCA into the vacated Backplane Assembly connector.

Installation



5. () Firmly grasp mainframe top cover in one hand and release safety latch by pressing it inboard with your other hand. Then, using both hands, carefully lower top cover to its closed position.

6. () Perform SELF-TEST (refer to "Self-Test").

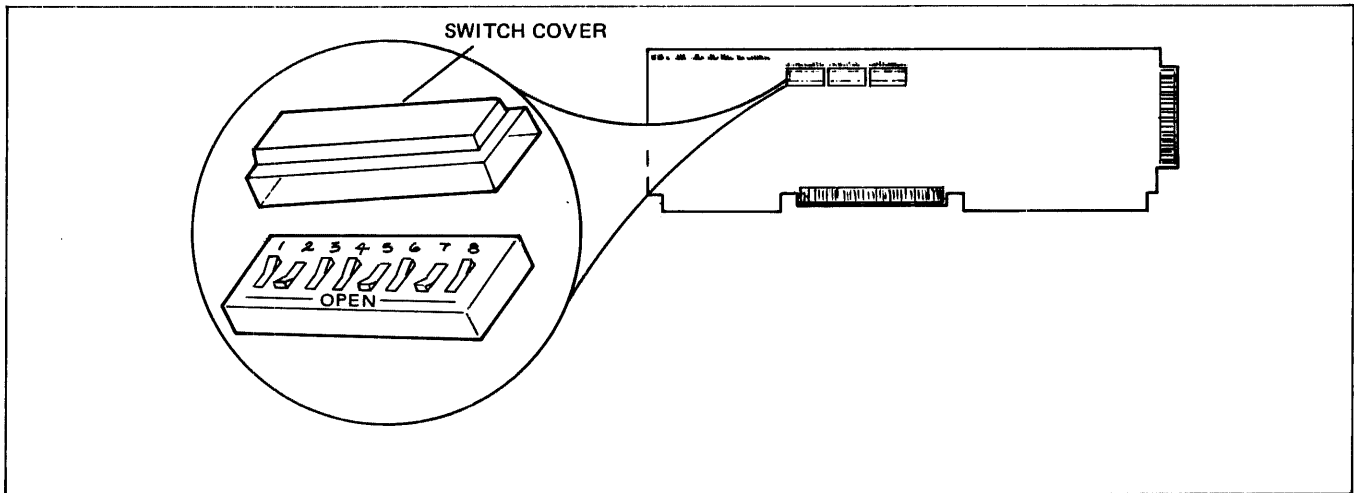


Figure 7-16. Typical Strapping Option Switch Assembly

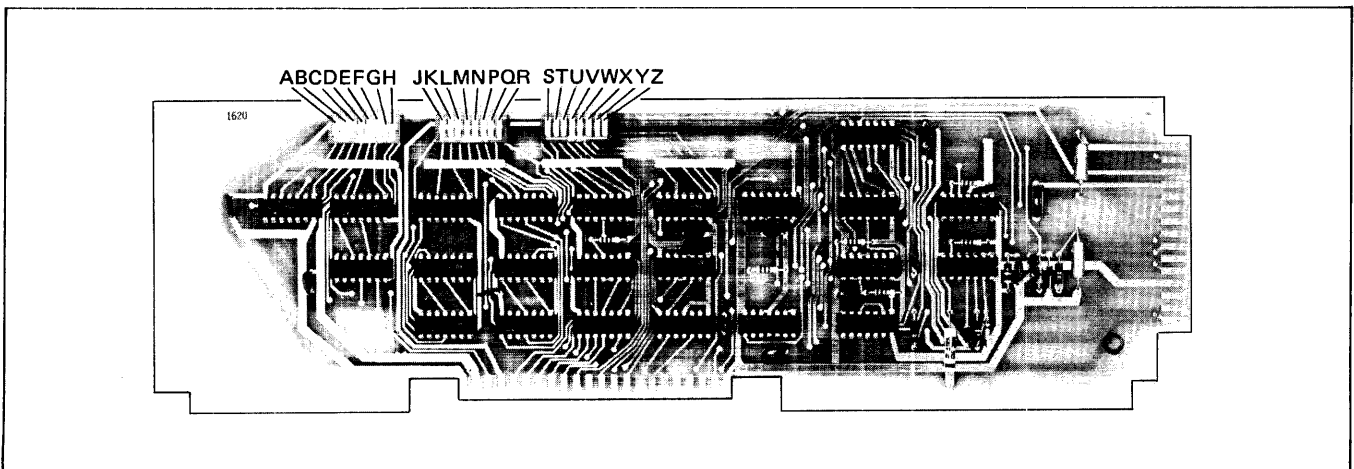


Figure 7-17. Keyboard Interface PCA Strapping Options

Table 7-4. Keyboard Interface PCA Strapping Options for Point-to-Point

STRAP	STRAPPING OPTION	NORMAL OPERATION (SWITCH CLOSED)	OPERATION WITH STRAPPING OPTION (SWITCH OPEN)
A	Function Key Transmission	The escape code sequence generated by the major function keys (such as, ROLL UP, ROLL DOWN, etc.) are executed locally, but not transmitted to the computer.	The escape code sequences generated by all keys are transmitted to the computer. If operating in half duplex, the function is also executed locally.
B	Space Overwrite (SPOW)	Spaces typed will overwrite existing characters.	When the SPOW latch is off, overwriting occurs as normal. When the SPOW latch is on, spaces cause the cursor to forward but not overwrite any existing characters. The SPOW latch is turned on by a Carriage Return, and off by a Line Feed, Home or Tab.
C	Cursor End-of-Line Wrap Around	At the end of each line, a local Carriage Return and Line Feed are generated; the cursor moves to the beginning of the next line.	A Carriage Return and Line Feed are not generated at the end of each line. The cursor remains in and overwrites column 80.
D	Line/Page Mode	The terminal is set to transfer a line at a time in Block Mode.	Entire pages of information are transferred in Block Mode.
E	Paper Tape Mode	When <input type="checkbox"/> READ key is pressed with <input type="checkbox"/> AUTO LF key latched down, each tape record begins with a LF and terminates with a CR.	Each tape record is terminated by CR(LF).
F	Fast Binary Read	The terminal transmission rate is determined by the BAUD RATE switch on the keyboard.	When an ESC e (Fast Binary Read) is issued by the computer, the baud rate is switched automatically to 9600 baud (if the terminal is equipped with cartridge tape units).
G	Block Transfer Handshake	In Block Mode, all data transfers to the computer are sent upon receipt of a DC1 from the computer.	All Block Mode transfers (i.e., cursor sense, terminal and device status, device I/O responses, display memory, and function keys) are preceded by a DC2. The terminal sends the DC2 upon receipt of a DC1 from the computer. After the CPU receives the DC2 from the terminal, another DC1 is required to trigger transmission of data from the terminal.
H	Inhibit DC2	During Block Mode Handshake transfers, the terminal sends a DC2 in response to a DC1 prior to sending data. (See Block Transfer Handshake strapping above.)	A DC1 from the computer is not required to trigger data transfers to the computer. Also, the DC2 from the terminal is not sent during Block Mode Transfer handshakes. (See Block Transfer Handshake strapping above.) Opening both switches G and H eliminate the terminal's use of the Handshake protocol entirely. Additionally, when the <input type="checkbox"/> ENTER key is pressed in Block Mode the cursor will be placed in the first column before transmission occurs if operating in Line/Field Mode (switch D closed) or Home'd if operating in Page Mode (switch D open).
J	Auto Terminate	No effect.	When in BLOCK mode and the ENTER key is pressed, places a non-displayable terminator after the cursor position.
K	Clear Terminator	No effect.	Clear terminator caused by Strapping Option J.
L	Self Test Inhibit	No effect.	Self Test function is inhibited. Pressing TEST key or issuing ESC z has no effect. TAPE TEST and DATA COMM SELF TEST functions are not affected.
M	INSERT and DELETE CHAR Reverse Sense	No effect.	Reverses control function of INSERT CHAR and DELETE CHAR key i.e., when key is pressed, line wrap around is in effect without having to press CNTL key. When either key is pressed while pressing CNTL, normal insert character and delete character functions are in effect.)

Table 7-4. Keyboard Interface PCA Strapping Operations for Point-to-Point (Continued)

STRAP	STRAPPING OPTION	NORMAL OPERATION (SWITCH CLOSED)	OPERATION WITH STRAPPING OPTION (SWITCH OPEN)
N	Escape Code Transfer	No effect.	Escape codes relating to the display (e.g., display enhancements, alternate character sets, format mode, fields, etc.) are sent to printer if it is selected as a destination device.
P,Q	(Not Used)		
R	Circuit Assurance	The transition from receive state to transmit state occurs after both CB (Clear to Send) and SB (Secondary Receive Data) go on within 2.6 seconds. Otherwise, the terminal returns to the receive state.	The transition from receive state to transmit state occurs after CB (Clear to Send) goes on.
S,T	Main Channel Protocol	Non-main channel protocol (both switches closed).	S-closed, T-open: Main channel with STX/ETX as Start of Data and End of Data. S-open, T-closed: Main channel with EOT as End of Data. S-open, T-open: Main channel with ETX as End of Data.
U	CPU Break	The CPU can interrupt the terminal while it is in the transmit state. The CPU initiates an ON to OFF transition of the SB (Secondary Receive Data) line. The terminal responds by turning off CA (Request to Send) and going to the receive state.	The terminal ignores all transitions on the SB (Secondary Receive Data) line from the modem in the transmit state.
V	Carrier Detect	When the terminal is in the receive state, an ON to OFF transition of CF (Carrier Detect) line from the modem causes the terminal to go into the transmit state. Transitions of CF have no effect while the terminal is in the transmit state.	Transitions of CF (Carrier Detect) line have no effect on the terminal.
W	Data Comrn Self Test Enable	Enables DATA COMM SELF TEST from either the keyboard or escape sequence.	Disables DATA COMM SELF TEST. If self test is attempted (by either the keyboard or escape sequence), the test will be aborted and ERROR 0 will appear on the display.
X	Data Speed Select	Holds data speed signal low (CH = 0).	Sets data speed signal high (CH = 1).
Y	Transmit LED	The TRANSMIT light on the keyboard is turned on when CB (Clear to Send) line from the modem is high. It is turned off when the CB line goes low.	The TRANSMIT light on the keyboard is turned on when the CC (Data Set Ready) line from the modem is high and the 13260B Extended Asynchronous Communications Interface PCA is used. It is turned off when the CC line goes low.
Z	Force Parity	The PARITY switch on the terminal keyboard is affected as follows:	
		<p>No Parity: Send 8 bits and receive 8 bits. Force bit 8 to zero.</p> <p>Odd Parity: Send 7 data bits + odd parity. Receive 7 data bits + odd parity. Check for parity error.</p> <p>Even Parity: Send 7 data bits + even parity. Receive 7 data bits + even parity. Check for parity error.</p>	<p>No Parity: Send 8 bits and receive 8 bits. Force bit 8 to one.</p> <p>Odd Parity: Send 7 bits + odd parity. Receive 7 bits. No check for parity error.</p> <p>Even Parity: Send 7 data bits + even parity. Receive 7 data bits. No check for parity error.</p>

Table 7-5. Keyboard Interface PCA Strapping Options for Multipoint

STRAP	STRAPPING OPTION	NORMAL OPERATION (SWITCH CLOSED)	OPERATION WITH STRAPPING OPTION (SWITCH OPEN)
A	Function Key Transmission	The escape code sequence generated by the major function keys (such as, ROLL UP, ROLL DOWN, etc.) are executed locally, but not transmitted to the computer.	(Same as switch closed.)
B	Space Overwrite (SPOW)	Spaces typed will overwrite existing characters.	When the SPOW latch is off, overwriting occurs as normal. When the SPOW latch is on, spaces cause the cursor to forward but not overwrite any existing characters. The SPOW latch is turned on by a Carriage Return, and turned off by a Line Feed, Home, or Tab.
C	Cursor End-of-Line Wrap Around	At the end of each line, a local Carriage Return and Line Feed are generated; the cursor moves to the beginning of the next line.	A Carriage Return and Line Feed are not generated at the end of each line. The cursor remains in and overwrites column 80.
D	Line/Page Mode	The terminal is set to transfer a line at a time from display memory, an unprotected field in format mode, or a record from the tape cartridge.	Transfers the entire contents of display memory (a "page"), all unprotected fields in format mode, or a file from the tape cartridge.
E	Paper Tape Mode	When the READ key is pressed with the AUTO LF down, each tape record begins with a LF and terminates with a CR.	Each tape record is terminated by CR(LF).
F	(Not Used)		
G	Block Transfer Handshake	No effect.	No effect.
H	Inhibit DC2	No effect.	No effect.
J	Auto Terminate	No effect.	When the ENTER key is pressed places a non-displayable terminator after the cursor position.
K	Clear Terminator	No effect.	Clear terminator caused by Strapping Option J.
L	Self Test Inhibit	No effect.	Self Test function is inhibited. Pressing TEST key or issuing ESC z has no effect. TAPE TEST and DATA COMM SELF TEST functions are not affected.
M	INSERT and DELETE CHAR Reverse Sense	No effect.	Reverses control function of INSERT CHAR and DELETE CHAR keys (i.e., when key is pressed, line wrap around is in effect without having to press CNTL key. When either key is pressed while pressing CNTL, normal insert character and delete character functions are in effect.)
N	Escape Code Transfer	No effect.	Escape codes relating to the display (e.g., display enhancements, alternate character sets, format mode, fields, etc.) are sent to printer if it is selected as a destination device.
P, Q	(Not Used)		
R	Set Trailing Pad	If in ASCII mode (switch J07 open on multipoint PCA), sets pad to 177 (octal) + parity. If in EBCDIC mode (switch J07 closed on multipoint PCA), sets pad to 377 (octal).	Sets pad to 377 (octal) if any of the following conditions are present: (1) PARITY switch on keyboard is set to NONE. (2) Switch Z on this PCA is open. (3) CRC-16 is selected (switch J06 on multipoint PCA is closed).
S	(Not Used)		

Table 7-5. Keyboard Interface PCA Strapping Options for Multipoint (Continued)

STRAP	STRAPPING OPTION	NORMAL OPERATION (SWITCH CLOSED)		OPERATION WITH STRAPPING OPTION (SWITCH OPEN)
		T	U	BLOCK SIZE (BYTES)
T, U	Output Block Size	C	C	1/2 Data Comm Buffer (refer to switches J16, J17 on multipoint PCA). 256 512 1024
		O	C	
		C	O	
O	O			
C = closed, O = open				
V	Continuous Carrier	Continuous carrier off indicates that the modem does not have continuous carrier.		Continuous carrier on indicates that the modem does have continuous carrier. Allows firmware to abort after 3 seconds of continuous carrier if terminator is not detected.
W	Data Comm Self Test Enable	Enables DATA COMM SELF TEST from either the keyboard or escape sequence.		Disables DATA COMM SELF TEST. If self text is attempted (by either the keyboard or escape sequence), the test will be aborted and ERROR 0 will appear on the display.
X	Data Speed Select	Holds data speed signal low (CH = off).		Sets data speed signal high (CH = on).
Y	Transmit Indicator	Lights TRANSMIT indicator on keyboard when terminal is communicating with the computer.		Lights TRANSMIT indicator on keyboard when Data Set Ready (CC) is on, and it goes out when CC goes off.
Z	Parity	The PARITY switch on the terminal keyboard is affected as follows:		
		<p>No Parity: Send 8 bits and receive 8 bits. Force bit 8 to zero. Check for parity error.</p> <p>Odd Parity: Send 7 data bits + odd parity. Receive 7 data bits + odd parity. Check for parity error.</p> <p>Even Parity: Send 7 data bits + even parity. Receive 7 data bits + even parity. Check for parity error.</p>	<p>No Parity: Send 8 bits and receive 8 bits. Force bit 8 to one. Check for parity error.</p> <p>Odd Parity: Send 7 bits + odd parity. Receive 7 bits + odd parity. Check for parity error.</p> <p>Even Parity: Send 7 data bits + even parity. Receive 7 data bits + even parity. Check for parity error.</p>	

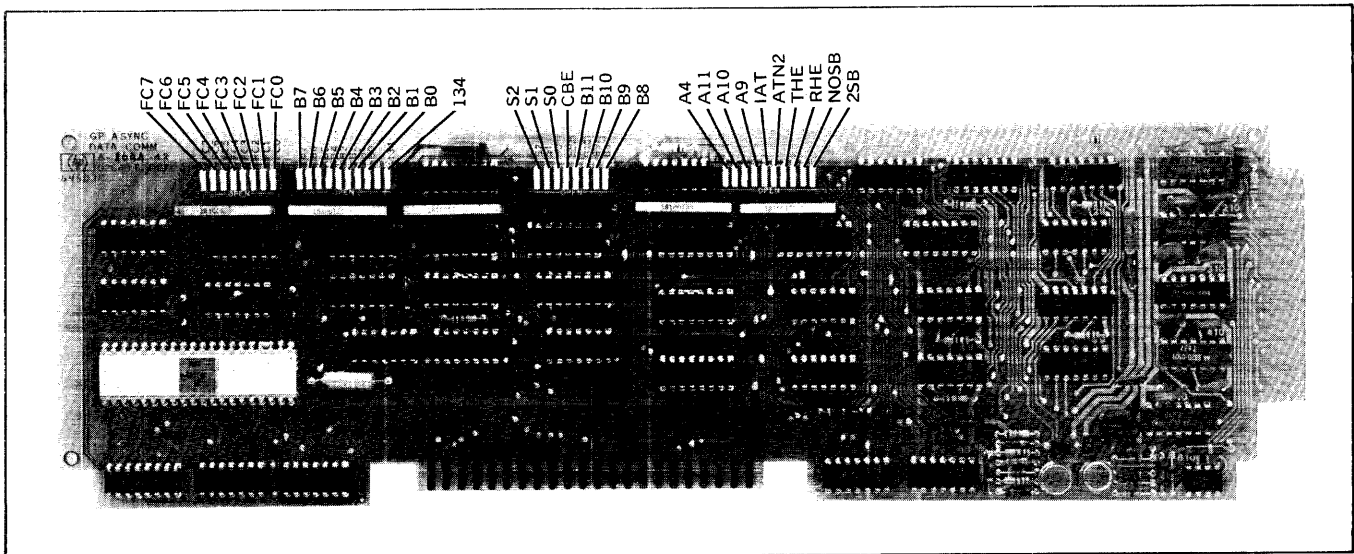


Figure 7-18. Extended Asynchronous Communications PCA Strapping Options

Table 7-6. Extended Asynchronous Communications Interface Strapping Options

STRAP	STRAPPING OPTION	DESCRIPTION																																				
FC0 thru FC7	(Not Used)	(This switch should always be open.)																																				
B0 thru B7	Custom Baud Rate Select	The switches are set to the binary equivalent of a number determined by the formula: $\text{INT} \left(\frac{153600}{\text{baud rate}} \right) - 1$ (See example in figure 5-10.)																																				
134	134.5 Baud	(This switch should always be open.)																																				
S0 thru S2	Transmit Baud Rate	<table border="1"> <thead> <tr> <th colspan="3">SWITCH SETTING</th> <th>TRANSMIT BAUD RATE</th> </tr> <tr> <th>S0</th> <th>S1</th> <th>S2</th> <th></th> </tr> </thead> <tbody> <tr> <td>O</td> <td>O</td> <td>O</td> <td>Transmit baud rate = receive baud rate.</td> </tr> <tr> <td>O</td> <td>C</td> <td>C</td> <td>110</td> </tr> <tr> <td>C</td> <td>O</td> <td>C</td> <td>150</td> </tr> <tr> <td>O</td> <td>O</td> <td>C</td> <td>300</td> </tr> <tr> <td>C</td> <td>C</td> <td>O</td> <td>1200</td> </tr> <tr> <td>O</td> <td>C</td> <td>O</td> <td>2400</td> </tr> <tr> <td>C</td> <td>C</td> <td>C</td> <td>Custom</td> </tr> </tbody> </table>	SWITCH SETTING			TRANSMIT BAUD RATE	S0	S1	S2		O	O	O	Transmit baud rate = receive baud rate.	O	C	C	110	C	O	C	150	O	O	C	300	C	C	O	1200	O	C	O	2400	C	C	C	Custom
		SWITCH SETTING			TRANSMIT BAUD RATE																																	
S0	S1	S2																																				
O	O	O	Transmit baud rate = receive baud rate.																																			
O	C	C	110																																			
C	O	C	150																																			
O	O	C	300																																			
C	C	O	1200																																			
O	C	O	2400																																			
C	C	C	Custom																																			
O = open, C = closed																																						
CBE	Custom Baud	Closed: Enables custom receive baud rates. (The keyboard BAUD RATE switch must be set to EXT.) Open: Receive baud rate is set by keyboard BAUD RATE switch.																																				
B8 thru B11	Custom Baud Rate Select	The switches are set to the binary equivalent of a number determined by the formula: $\text{INT} \left(\frac{153600}{\text{baud rate}} \right) - 1$																																				
A4,A9 thru A11	Module Address	Provides PCA address so that firmware can address the PCA. These switches should always be set to 10, (A4 open, A9 thru A11 closed).																																				
IAT	Inhibit Attention	(This switch must be closed when receive handshake is used.)																																				
ATN2	Enable Attention Two	(This switch should always be open.)																																				
THE	Transmit Handshake Enable	Closed: Permits the associated external device (a or computer) to signal a "busy" condition on CB (Clear to Send) or SCF (Secondary Carrier) control lines and temporarily stop data transmission from the terminal. Open: Transmit Handshake disabled.																																				
RHE	Receive Handshake Enable	Closed: Permits the terminal to signal a "busy" condition on the CD (Data Terminal Ready) control line and temporarily stop data transmission from the associated external device (a computer). Open: Receive Handshake Disabled.																																				
NOSB	SCF Inhibit	Closed: Inhibits RS232 SCF (Secondary Carrier) control line. Open: Enables RS232 SCF (Secondary Carrier) control lines.																																				
2SB	Stop Bit Select	Selects the number of stop bits to be appended to the data bits during transmission. Closed: Selects 2 stop bits. Open: Selects 1 stop bit. NOTE: Selecting 110 baud automatically appends 2 stop bits.																																				

Table 7-7. Asynchronous Multipoint Communications Interface Strapping Options

STRAP	STRAPPING OPTION	DESCRIPTION		
J10 thru J14	Device ID	Selects device ID code (0-27) which identifies one terminal from another on a particular communication line. For example: to set an ID code of 6, set switches J14 through J10 to 00110 respectively. (See "Device I.D. Number" and "Configuration Procedure" in Section V.) 0 = closed, 1 = open		
J15	Block Mode	Open: An entire input block must be received correctly before being processed by the terminal firmware. (See Block Check Character.) Closed: Each character is processed by the terminal firmware as it is received from the computer.		
J16, J17	Buffer Size Select	J17	J16	BUFFER SIZE
		C	C	512 bytes
		C	O	1024 bytes
		O	C	2048 bytes
		O	O	4096 bytes
C = closed, O = open				
J00 thru J04	Group ID	Selects group ID code (0-27) which identifies the communications line that the terminal is on. For example: to set an ID code of 20, set switches J04 thru J00 to 10100 respectively. (See "Device I.D. Number" and "Configuration Procedure" in Section V.) 0 = closed, 1 = open		
J05	Sync Mode	Open: Enables the insertion and deletion of sync characters to be compatible with a single, generalized data communications driver. Closed: Sync Mode Disabled.		
J06	BCC (Block Check Character)	Determines which type of parity check will be used for an entire block of data in Block Mode. Closed = 0: LRC (longitudinal redundancy check) Open = 1: CRC — 16 (cyclic redundancy check)		
J07	Code Select	Selects data character and control character code format. Open = 1: EBCDIC Closed = 0: ASCII		
INT	Firmware Interrupt	This switch should always be open.		
PL0 thru PL6	Poll Bits	These switches should always be open.		
A4, A9 thru A11	Module Address	Provides PCA address so that the firmware can address the PCA. These switches should always be set to 7 (A4 closed, A9 thru A11 open).		
- 12	13232T Accessory Power	Closed: Provides - 12 volts for operation of relays in the 13232T Power Protect Multipoint Cable. Open: No power supplied.		
2SB	Stop Bit Select	Selects the number of stop bits to be appended to the data bits during transmission. Open: Selects 2 stop bits. Closed: Selects 1 stop bit (normal position)		

Table 7-8. Synchronous Multipoint Communications Interface Strapping Options

STRAP	STRAPPING OPTION	DESCRIPTION															
J10 thru J14	Device ID	Selects device ID code (0-27) which identifies one terminal from another on a particular communication line. For example: to set an ID code of 6, set switches J14 thru J10 to 00110 respectively. (See "Device I.D. Number" and "Configuration Procedure" in Section V.) 0 = closed, 1 = open															
J15	Block Mode	Open: An entire input block must be received correctly before being processed by the terminal firmware. (See Block Check Character.) Closed: Each character is processed by the terminal firmware as it is received from the computer.															
J16, J17	Buffer Size Select	<table border="1"> <thead> <tr> <th>J17</th> <th>J16</th> <th>BUFFER SIZE</th> </tr> </thead> <tbody> <tr> <td>C</td> <td>C</td> <td>512 bytes</td> </tr> <tr> <td>C</td> <td>O</td> <td>1024 bytes</td> </tr> <tr> <td>O</td> <td>C</td> <td>2048 bytes</td> </tr> <tr> <td>O</td> <td>O</td> <td>4096 bytes</td> </tr> </tbody> </table> <p>C = closed, O = open</p>	J17	J16	BUFFER SIZE	C	C	512 bytes	C	O	1024 bytes	O	C	2048 bytes	O	O	4096 bytes
J17	J16	BUFFER SIZE															
C	C	512 bytes															
C	O	1024 bytes															
O	C	2048 bytes															
O	O	4096 bytes															
J00 thru J04	Group ID	Selects group ID code (0-27) which identifies the communications line that the terminal is on. For example: to set an ID code of 20, set switches J04 thru J00 to 10100 respectively. (See "Device I.D. Number" and "Configuration Procedure" in Section V.) 0 = closed, 1 = open															
J05	IBM 3270 Text Mode	Open: See "IBM 3270 Text Mode Compatibility/Synchronous Mode", Section V. Closed: 3270 Text Mode Disabled.															
J06	BCC (Block Check Character)	Determines which type of block check will be used for an entire block of data. Closed = 0: LRC (longitudinal redundancy check) Open = 1: CRC — 16 (cyclic redundancy check)															
J07	Code Select	Selects data character and control character code format. Open = 1: EBCDIC Closed = 0: ASCII															
-12	13232T Accessory Power	Closed: Provides -12 volts for operation of relays in the 13232T Power Protect Multipoint Cable. Open: No power supplied.															
A4, A9 thru A11	Module Address	Provides PCA address so that the firmware can address the PCA. These switches should always be set to 7 (A4 closed, A9 thru A11 open).															
RCLK	Receive Data Clock	When the terminal is directly connected to a computer (no modem) by using the 13232U Modem Bypass Cable, the PCA can provide the receive data clock (DD) by closing this switch. (This applies only to the first terminal in the multipoint chain.) Normally, this switch is open. One of the transmit data clock switches (see below) must be selected for this function.															
2400 4800 9600	Transmit Data Clock	Usually, the modem or computer provides both the receive (DD) and transmit (DB) data clocks for timing the data transfers. If the modem requires a terminal-supplied transmit clock (DA), select the appropriate rate for that modem. If using the 13232U Modem Bypass Cable, select the desired rate. Normally, 9600 should be closed for the DATA COMM SELF TEST.															
<div style="border: 1px solid black; padding: 5px; display: inline-block;">CAUTION</div> <p>Close only one switch, otherwise damage to the PCA may result.</p>																	

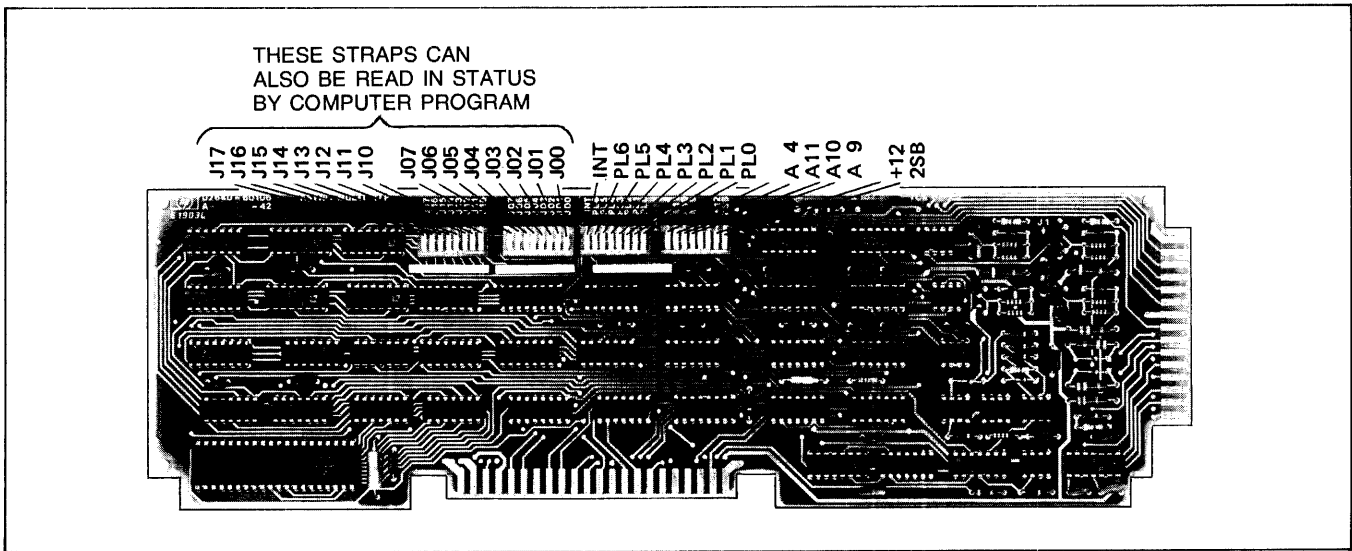


Figure 7-19. Asynchronous Multipoint Communications PCA Strapping Options

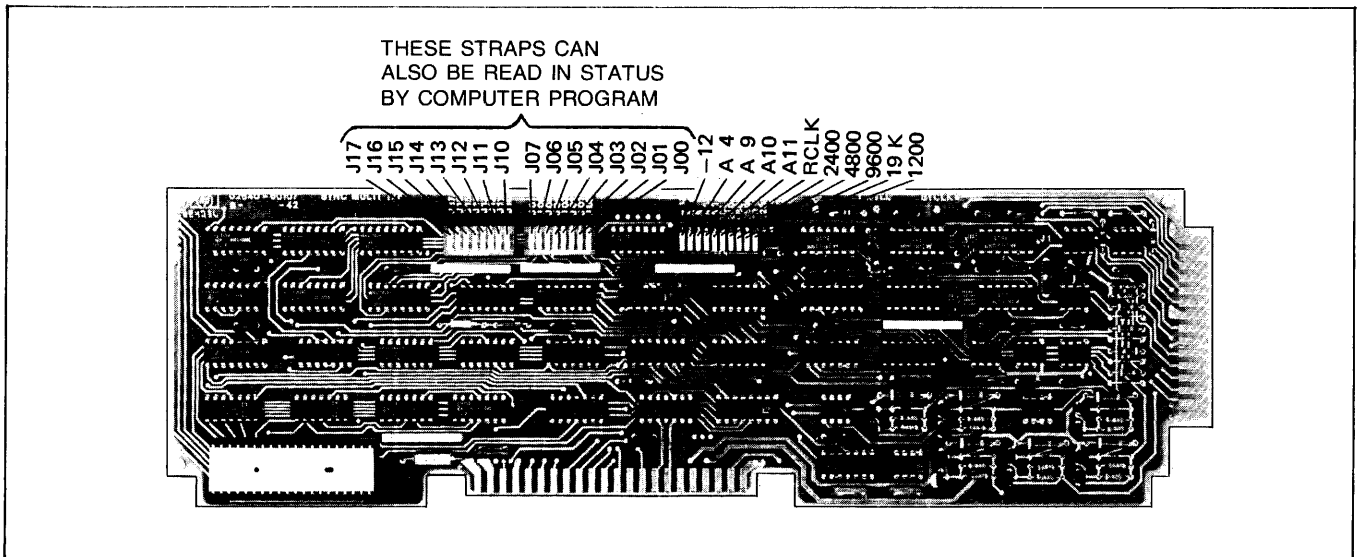


Figure 7-20. Synchronous Multipoint Communications PCA Strapping Options

DATA COMMUNICATIONS CABLING

INTERFACE SIGNALS

The RS232 signals available on each of the communication interfaces are listed in table 7-9. This information can be used to verify interface capability or to fabricate special interface cables. Refer to "Fabricating Your Own Data Communications Cable" for additional cabling information.

LOGIC LEVELS

Table 7-10 gives the logic levels of signals used by the 13260 series data communications accessories.

CABLE TYPES

There are five cable types that are available for use in multipoint networks. These cables are described in table 7-11.

Table 7-9. EIA RS232C and CCITT V24 Interface Data and Control Signals

CONNECTOR					CIRCUIT		DESCRIPTION	MODEM		GND	DATA	CON-TROL	TIMING
R S 2 3 2	P2 13260				R S 2 3 2	C C I V T 2 T 4		TO	FROM				
	A	B	C	D									
—	A	A	A	A	AA	—	Protective Ground			X			
7	H	H	H	H	AB	102	Signal Ground/Common Return			X			
2	B	B	B	B	BA	103	Transmitted Data	X			X		
3	C	C	C	C	BB	104	Received Data		X		X		
4	D	D	D	D	CA	105	Request to Send	X				X	
5	E	E	E	E	CB	106	Clear to Send		X			X	
6	F	F	F	F	CC	107	Data Set Ready		X			X	
20	P	P	P	P	CD	108.2	Data Terminal Ready	X				X	
22	—	—	14	14	CE	125	Ring Indicator		X			X	
8	J	J	J	J	CF	109	Received Line Signal Detector		X			X	
—	—	—	—	—	CG	110	Signal Quality Detector	X				X	
23	—	R	R	R	CH	111	Data Rate Selector (DTE Source)	X				X	
—	—	—	—	—	CI	112	Data Rate Selector (DCE Source)		X			X	
24	—	—	S	S	DA	113	Transmitter Timing (DTE Source)	X					X
15	—	—	—	12	DB	114	Transmitter Timing (DCE Source)		X				X
17	—	—	—	13	DD	115	Receiver Timing		X				X
—	—	—	—	—	SBB	118	Secondary Transmitted Data	X			X		
—	—	—	—	—	SBB	119	Secondary Received Data		X		X		
19	M	M	M	M	SCA	120	Secondary Request to Send	X				X	
—	—	—	—	—	SCB	121	Secondary Clear to Send		X			X	
12	N	N	N	N	SCF	122	Secondary Received Line Detector		X			X	

Table 7-10. Data Communications Signal Levels

DATA:		
Name	Space	Mark
Logic	0	1
Voltage	>+3V but <+25V	<-3V but >-25V
CONTROL:		
	ON (true)	OFF (false)
CLOCK SIGNALS:		
	0 = ground	1 = +5V

Table 7-11. Multipoint Data Communication Cables

ACCESSORY NO.	DESCRIPTION	SYMBOL
13232N	Male RS232C Modem to terminal cable	
13232P	RS232 Modem to terminal plus multipoint	
13232Q	Multipoint terminal to terminal	
13232R	Multipoint extender	
13232T	Power Down protect (same symbol as Q)	
13232U	Modem Bypass	

where:

- = RS232 (Modem) connector (female)
- = Terminal hood connector
- = Multipoint connector (female)
- = Male connector i.e., or

For example, to connect 3 terminals you could use the following configuration:



POINT-TO-POINT COMMUNICATIONS CABLING

Figures 7-21 through 7-23 show the cable connections and signals used by the 13260A/B/C/D and 13250A accessories.

MULTIPOINT COMMUNICATIONS CABLING

Figures 7-24 and 7-25 show the cable connections and signals used by the 13260C/D accessories in the multipoint configuration.

POWER DOWN PROTECT CABLING

Figure 7-26 and 7-27 show the cable configuration and effects of signal switching during power-down.

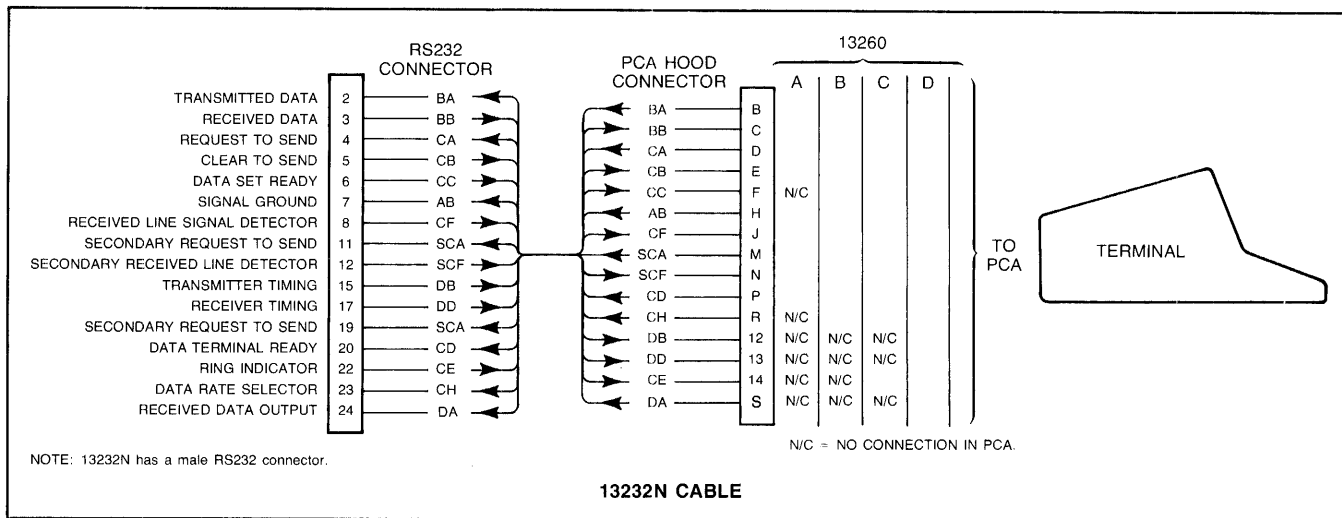


Figure 7-21. Point-to-Point Communications Cabling

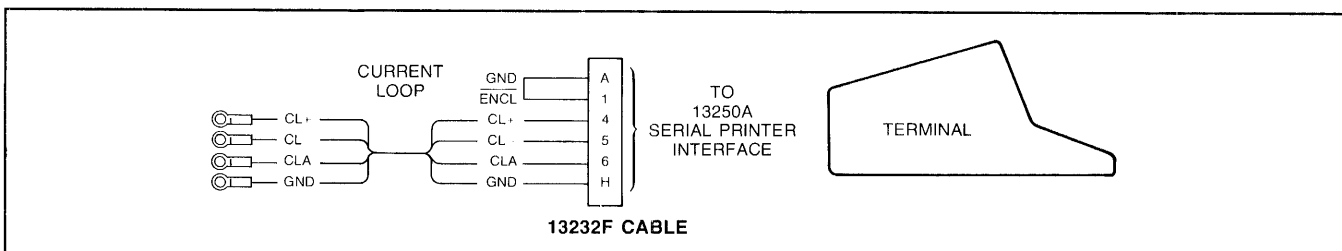


Figure 7-22. Current Loop Cabling

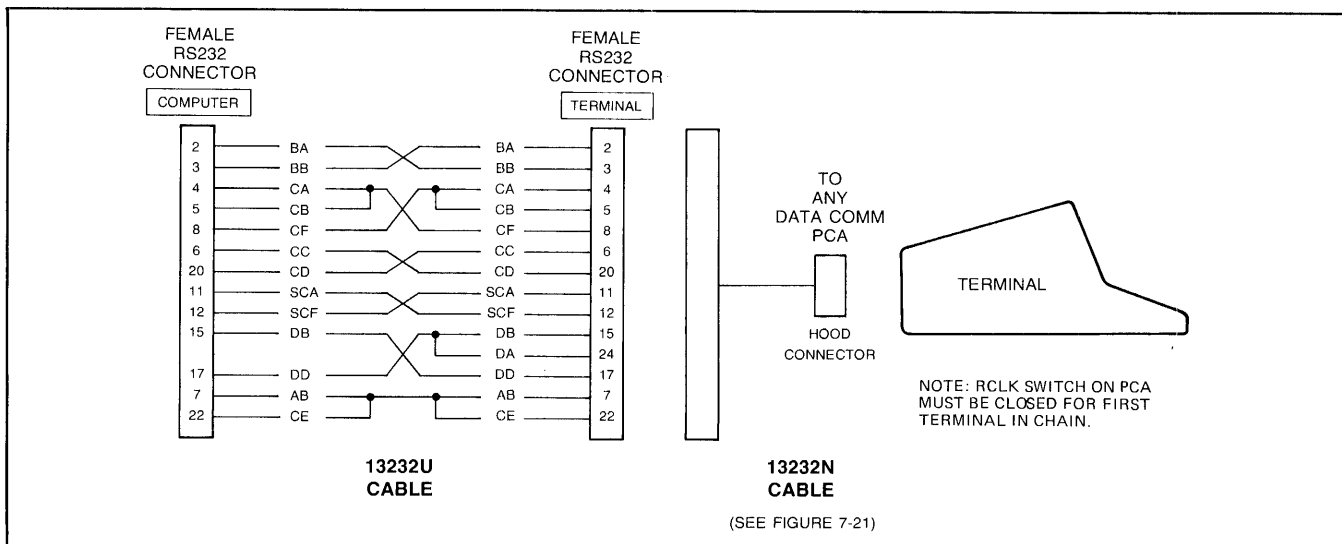


Figure 7-23. Modem By-Pass Cabling

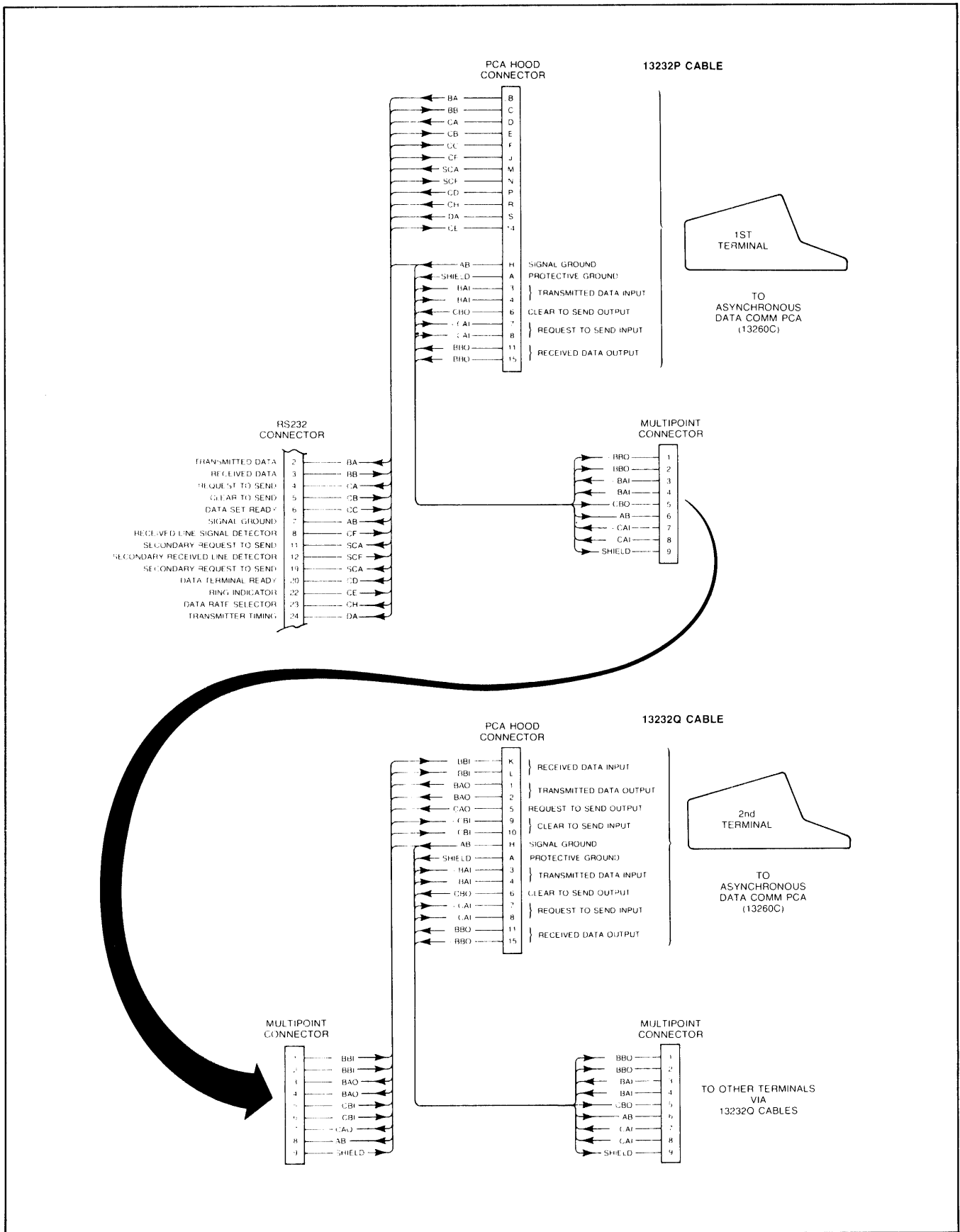


Figure 7-24. Asynchronous Multipoint Cabling

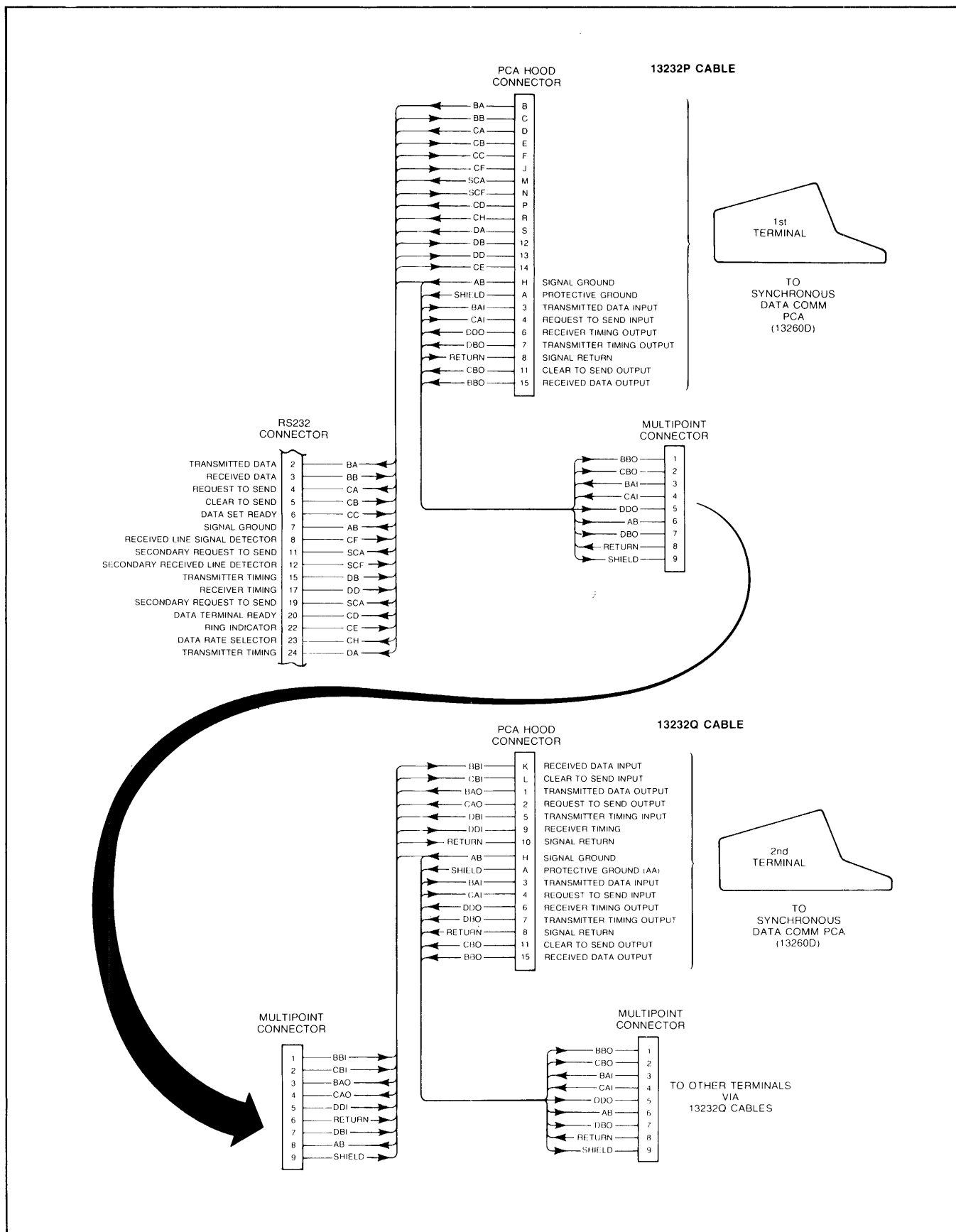


Figure 7-25. Synchronous Multipoint Cabling

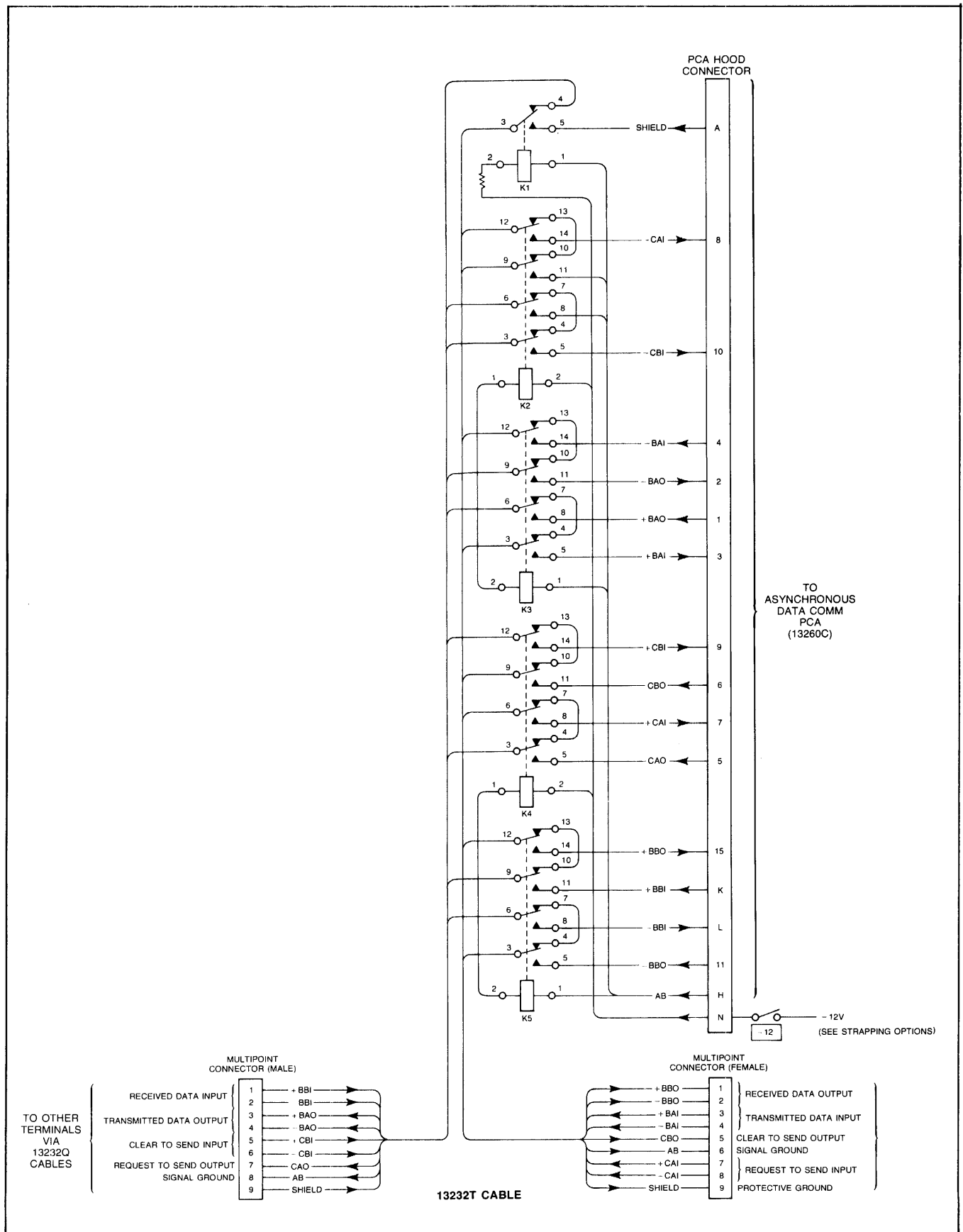


Figure 7-26. Power-Down-Protect Cabling for Asynchronous Multipoint Configuration

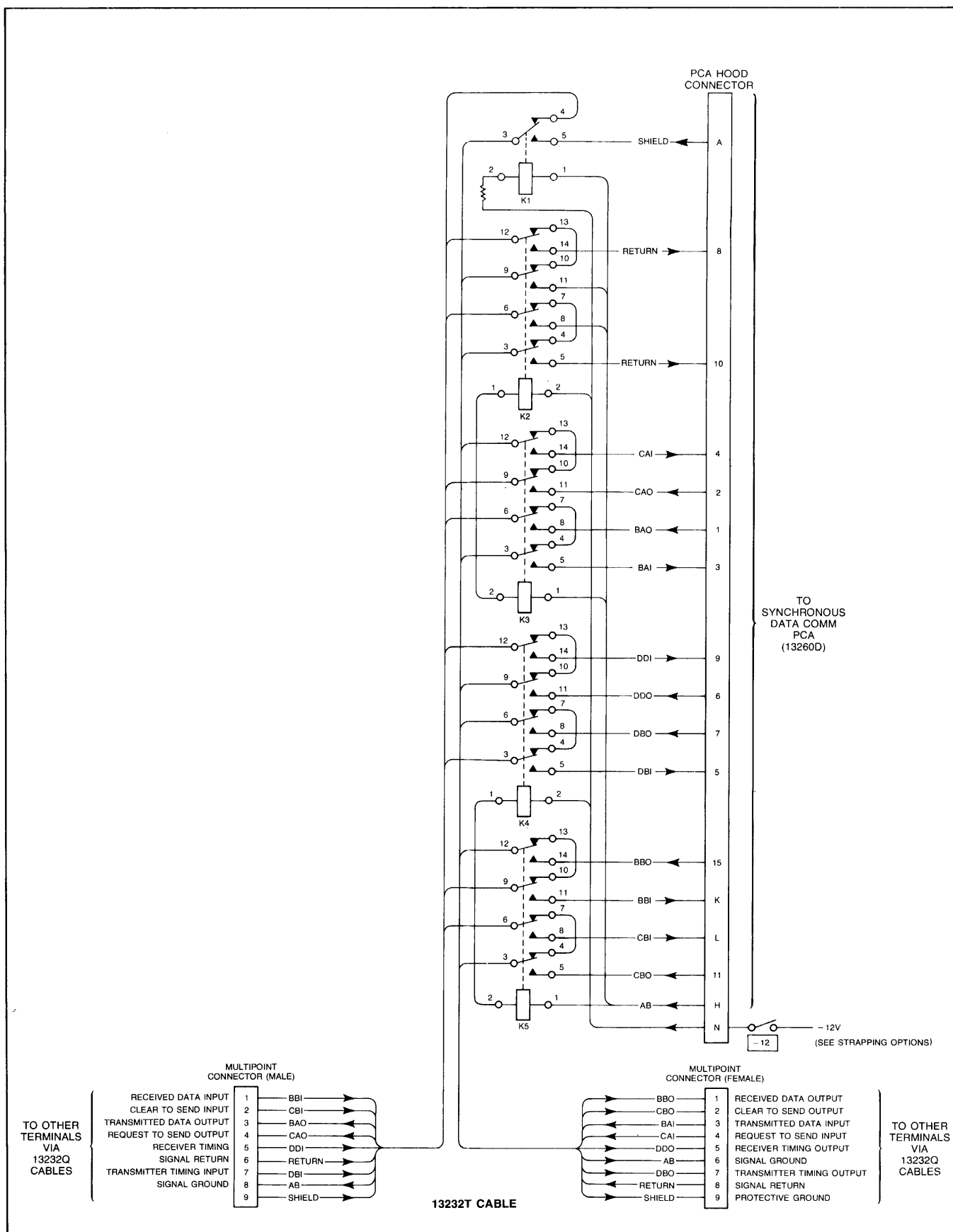


Figure 7-27. Power-Down-Protect Cabling for Synchronous Multipoint Configuration

FABRICATING YOUR OWN DATA COMMUNICATIONS CABLE

PCA hood connectors, RS232C connectors, multipoint connectors, and cables are available should you need to fabricate your own data communications cable. Part numbers of the items are given in table 7-12.

Figures 7-28 through 7-30 show the details of assembling each type of connector. Table 7-13 lists the interface signals on each of the data communications PCA's. Also, the illustrations of the HP cables (figures 7-21 through 7-27) may be used as a guide.

There are maximum length limitations on each type of cable. The following may be used as a guide for length considerations.

Maximum Distances:

Modem/Computer to first terminal: 50 feet (RS232-C standard)

Modem/Computer to terminal: 1000 feet (current loop on 13260B)

Terminal to terminal —
Note: Maximum total distance 16,000 feet.

Asynchronous (13260C) @ 300 to 9600 bits per second: up to 2000 feet between terminals with up to 32 terminals per line.

Synchronous (13260D) (2000 feet maximum between terminals):

Terminals/ Line	Bits/ Sec.		
	2400	4800	9600
4	2000 ft	2000 ft	2000 ft
8	2000 ft	2000 ft	1200 ft
16	2000 ft	1200 ft	480 ft
32	1200 ft	480 ft	120 ft

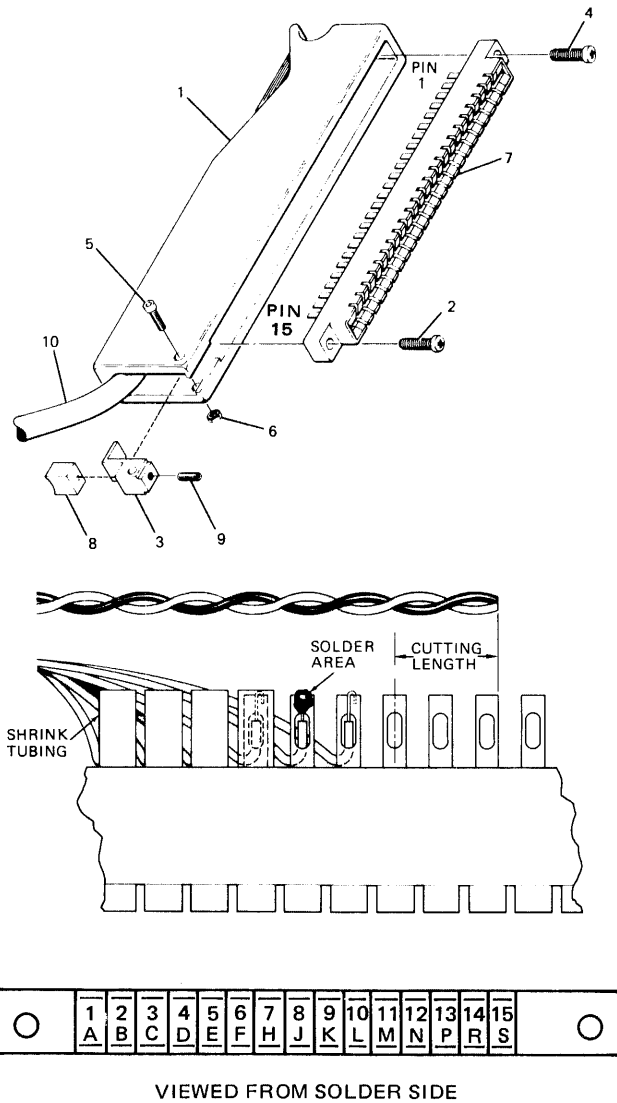
Table 7-12. Parts for Fabricating Your Custom Data Communications Cable

ITEM	HP PART NO.	ALTERNATE SOURCE	DESCRIPTION
RS232 Connector	5061-2405		(See figure 7-29.)
PCA Hood Connector	5061-1340		(See figure 7-28.)
Multipoint Connector	5061-2401		(See figure 7-30.)
PCA Hood to RS232 Connector Cable	8120-1903 or 8120-1930		26 AWG (or greater) Low Voltage Computer Cable.
Multipoint Cable	8120-2305	Brand Rex POSS4P22	22 AWG, 4 twisted pairs, overall shield, 75 ohm differential mode characteristic impedance.
Note: All connectors include contacts.			

Table 7-13. 13260 Series Data Communications PCA Signal Names

P2 PIN	SIGNAL NAMES			
	13260A	13260B	13260C	13260D
1	(no connection)	ENCL (see note)	+BAO	BAO
2	(no connection)	INI	-BAO	CAO
3	(no connection)	CL+ 12	+BAI	BAI
4	(no connection)	CL+ (see note)	-BAI	CAI
5	(no connection)	CL- (see note)	CAO	DBI
6	(no connection)	CLA (see note)	CBO	DDO
7	(no connection)	CLP	+CAI	DBO
8	(no connection)	INO	-CAI	RET-D
9	(no connection)	PON	+CBI	DDI
10	(no connection)	ISB	-CBI	RET-U
11	(no connection)	XECL	-BBO	CBO
12	(no connection)	TTY IN	(no connection)	DB
13	(no connection)	+5V	(no connection)	DB
14	(no connection)	CE	CE	CE
15	TEST	TEST	+BBO	BBO
A	AB	GND	AA	AA
B	BA	BA	BA	BA
C	BB	BB	BB	BB
D	CA	CA	CA	CA
E	CB	CB	CB	CB
F	(no connection)	CC	CC	CC
H	AB	AB (see note)	AB (GND)	AB (GND)
J	CF	CF	CF	CF
K	X8OUT	X8OUT	+BBI	BBI
L	X16OUT	X16OUT	-BBI	CBI
M	SCA	SCA	SCA	SCA
N	SCF	SCF	SCF	SCF
P	CD	CD	CD	CD
R	(no connection)	CH	CH	CH
S	X16IN	X16IN	(no connection)	DA

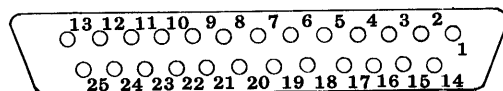
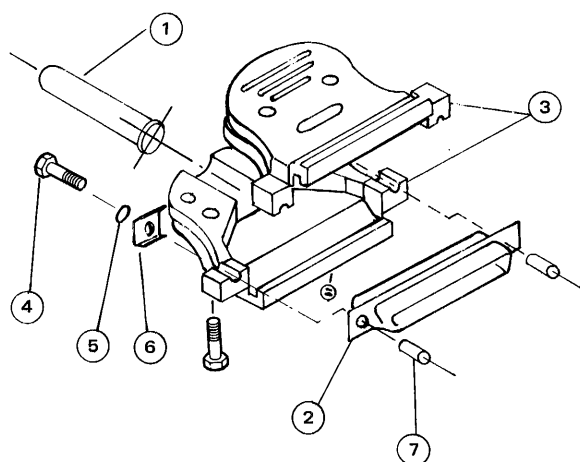
NOTE: Used in current loop mode.



Assembly Procedure:

1. () Insert approximately 10 inches of cable (item 10) into the connector hood (item 1).
2. () Strip the outer jacket of the cable back 5 inches.
3. () Remove approximately 1/4-inch of insulation from each signal wire.
4. () Starting at the end of the 30-pin connector (item 7) nearest pins S and 15, solder the signal wires to the appropriate pins on the connector, and insulate each pin with tubing as shown at left.
5. () Install the 30-pin connector in the connector hood using the two self-tapping screws (items 2 and 4).
6. () Install the cable clamp (items 3 and 8), and tighten it in place with the screw and nut (items 5 and 6).
7. () Tighten the cable clamp on the cable with the setscrew (item 9).

Figure 7-28. Assembling the PCA Hood Connector

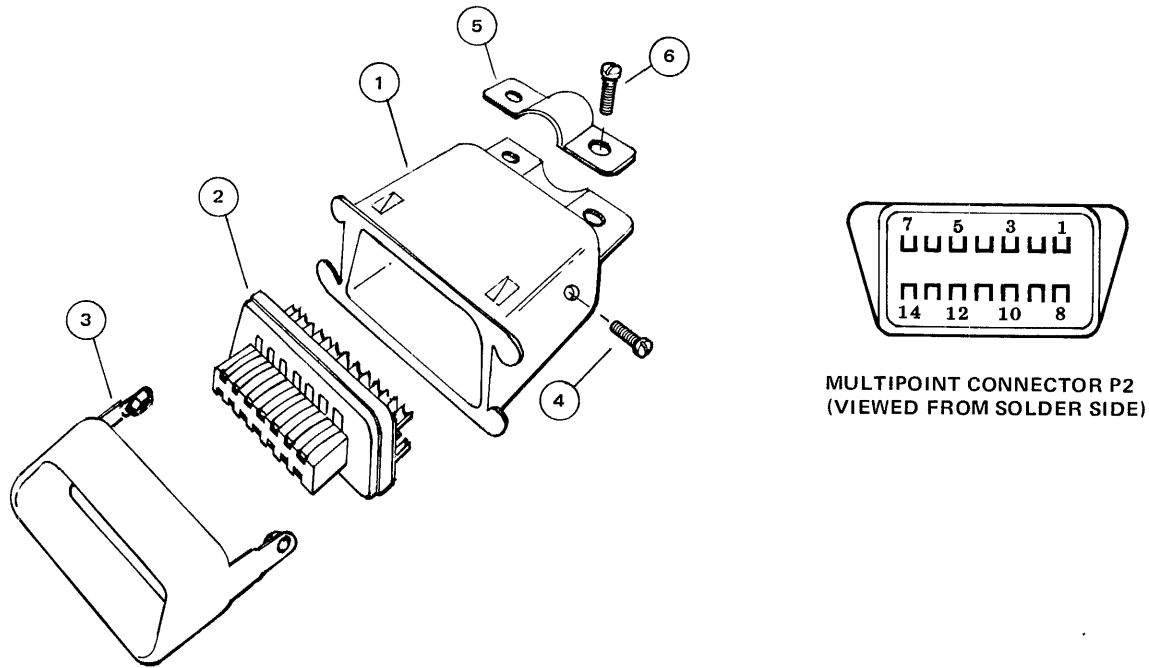


VIEWED FROM SOLDER SIDE

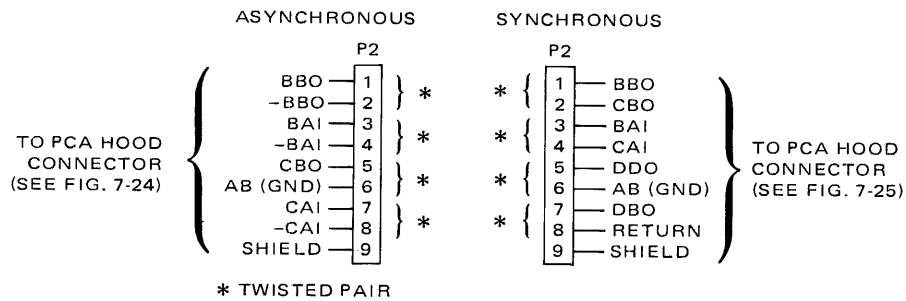
Assembly Procedure:

1. () Slide rubber bushing (item 1) over end of cable, leaving about 6 inches of cable end exposed for wire stripping, etc.
2. () Strip back the cable jacket 1-inch.
3. () Clip the unused conductor wires to the edge of the cable jacket.
4. () Remove 1/4-inch of insulation from the ends of the conductor wires to be used.
5. () Solder the conductor wires onto the contacts of the contact assembly (item 2). (Select either the male or female contact assembly provided for your particular application.)
6. () Slide the rubber bushing to the end of the cable such that the rubber bushing flange is flush with the stripped end of the cable jacket.
7. () Assemble the two halves of the connector (item 3) onto the contact assembly (item 2). (Use the screws and nuts provided.)
8. () Mount the two screws, threaded spacers, and other hardware (items 4 thru 7) onto the contact assembly.

Figure 7-29. Assembling the RS232C Connector



MULTIPOINT CONNECTOR CABLING



Assembly Procedure:



1. () Insert cable through the outer housing (item 1).
2. () Strip back the cable jacket 1-inch.
3. () Clip any unused conductor wires to the edge of the cable jacket.
4. () Remove 1/4-inch of insulation from the ends of the conductor wires to be used.
5. () Solder the conductor wires onto the contacts of the contact assembly (item 2).
6. () Assemble the multipoint connector by sliding the inner housing (item 3) over the contact assembly (item 2). Slide the outer housing over items 2 and 3 until the screw holes are aligned. Secure the entire assembly with the two screws (item 4).
7. () Mount the cable clamp (item 5), and secure with the two screws (item 6).

Figure 7-30. Assembling the Multipoint Connector

SELF-TEST

The terminal tests itself. Should you suspect a malfunction while operating the terminal, you can perform the SELF-TEST function to check out the terminal. Also, after installing any accessory, the terminal's self-test function should be performed to insure that the terminal is functioning properly. There are three types of self-test, each testing a specific function of the terminal.


BASIC SELF-TEST

Pressing , checks out the terminal, except for the cartridge tape units (if installed) and the data communications. The following is performed when the  key is pressed (also see the flowchart in figure 7-32):

- The light-emitting diodes (indicators) on the keyboard are turned on briefly as an indication that the power supply and microprocessor board are functioning.
- A checksum test is done on the read-only memory (ROM). This verifies that the firmware is working properly. An error here causes a ROM ERROR message to be displayed. (See flowchart, figure 7-32.)
- A checkerboard test is performed on the random access memory. An error here causes a RAM ERROR message to be displayed. (See flowchart, figure 7-32.)
- The bell is beeped indicating success up to this point.

- The entire character set contained in the terminal is displayed.
- A line of characters, @ABCDEFGHIJKLMNO, is displayed. If the Display Enhancement option is installed, then Underline, Half-Bright, and Blinking will be displayed with Inverse Video in all of the possible Display Enhancement combinations by this line of characters.
- The 14 bytes of status information are displayed. (See Section VI "Status" for an explanation of the status bytes.)

Generally, if the terminal beeps and the display shows a pattern similar to those shown in figure 7-31 then the terminal is functioning properly (only those character sets actually present in the terminal will be displayed in the test pattern and consequently the actual test pattern displayed will be dependent on which features are present in each terminal).

 must be pressed to resume operation if any error occurred. However, the station's operation will not be reliable if the Self-Test failed.

NOTE

The test pattern cannot be recorded because of imbedded Record Separators (RS).

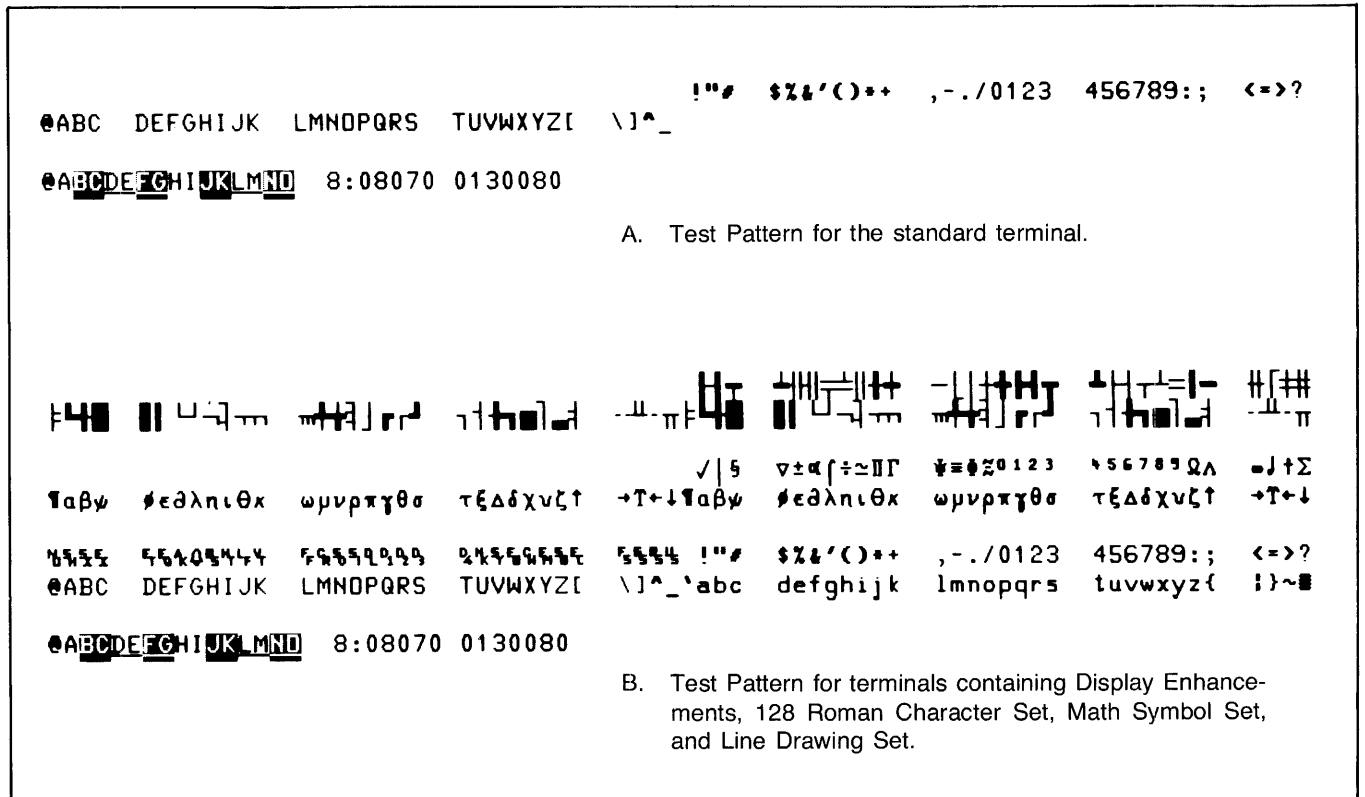


Figure 7-31. Basic Self-Test Patterns (HP 2645A)

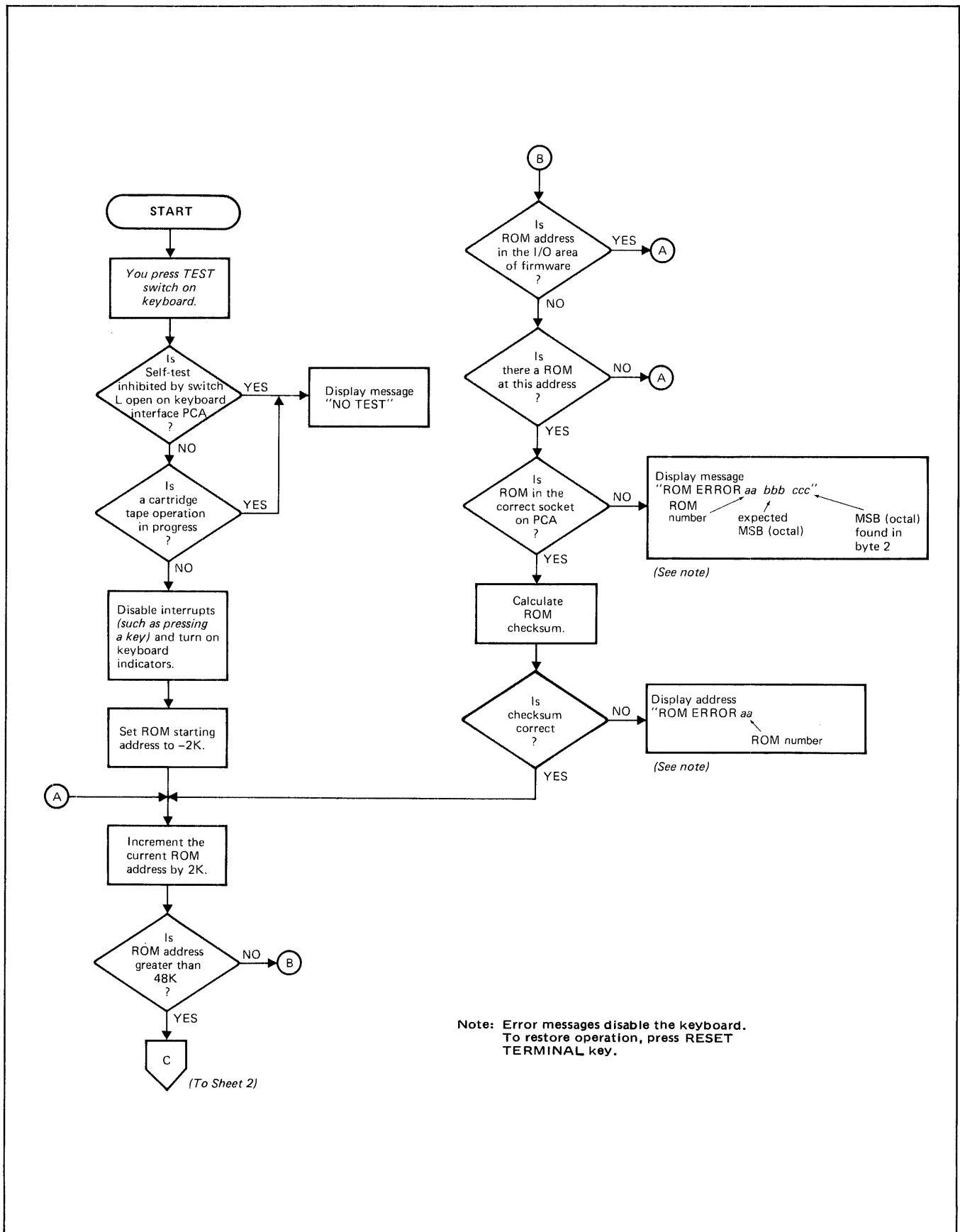


Figure 7-32. Basic Terminal Self-Test Flowchart (Sheet 1 of 3)

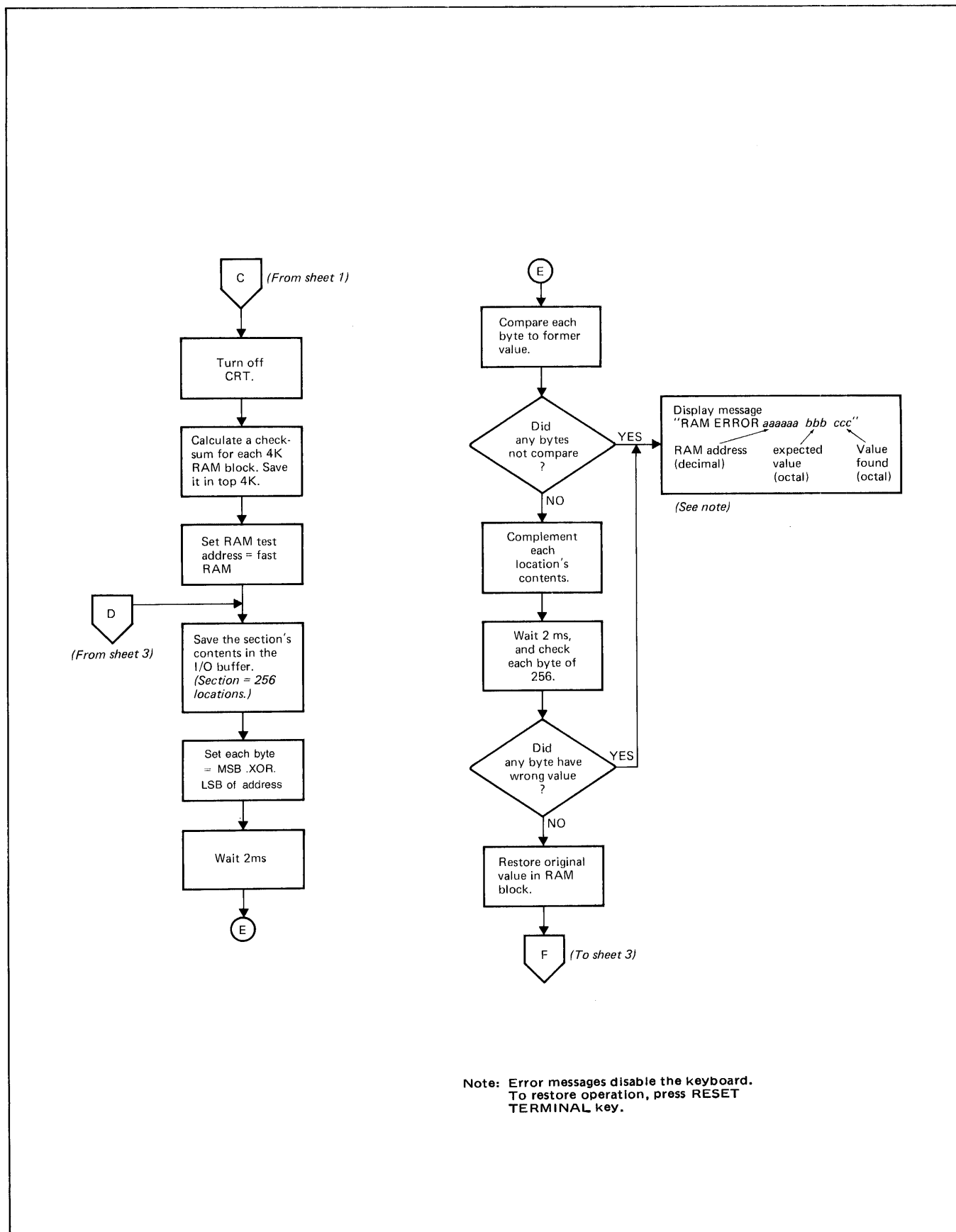
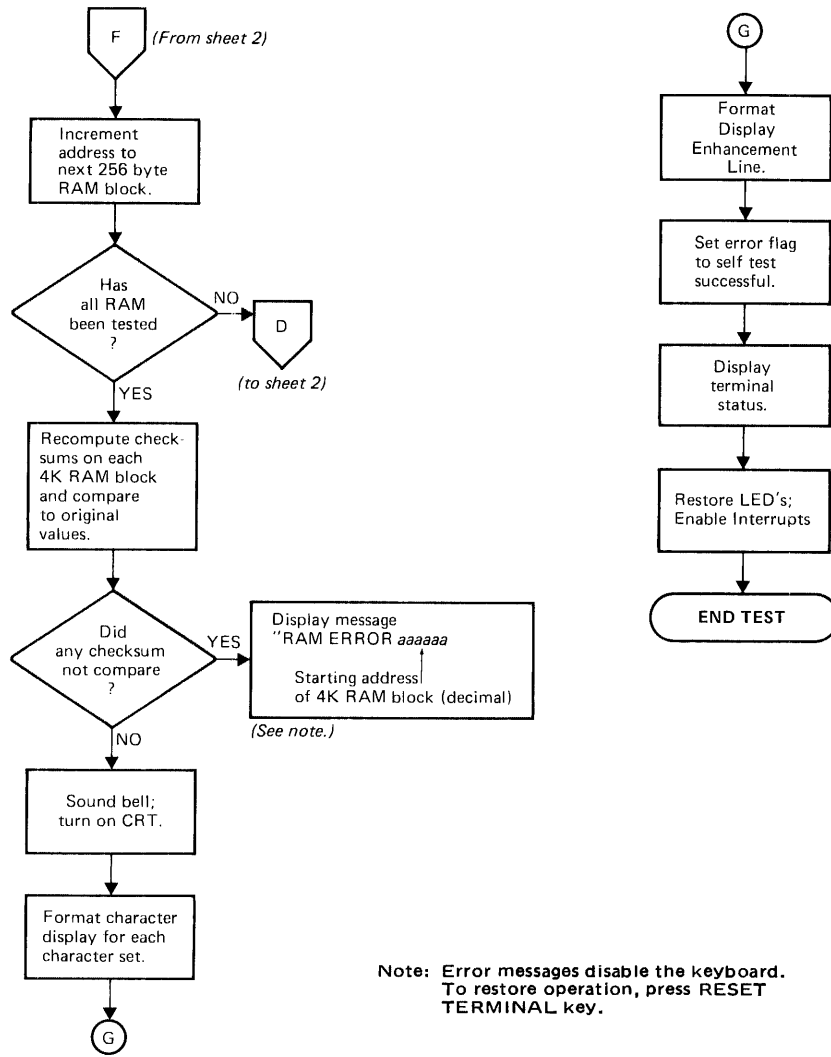


Figure 7-32. Basic Terminal Self-Test Flowchart (Sheet 2 of 3)




Note: Error messages disable the keyboard. To restore operation, press RESET TERMINAL key.

Figure 7-32. Basic Terminal Self-Test Flowchart (Sheet 3 of 3)

CARTRIDGE TAPE UNIT SELF-TEST

CAUTION

The following self-test is performed with two unprotected tape cartridges. Make sure that any data on these tapes need not be saved.


FROM THE KEYBOARD. The following is performed when the (green) key is pressed then the  key is pressed:

- A test is performed on the left tape unit:
 - A worst case data pattern ("%Z" repeated 128 times to form a 256 character record) is recorded on the tape cartridge.
 - The tape is backspaced over the record to the beginning of the test pattern.
 - The test pattern is read and verified.
 - A file mark is recorded.
- Two basic self-tests are performed as described previously.
- A test is performed on the right tape unit (same as the left tape unit).
- Another basic self-test is performed.

If a fault is detected during the tape transport test, the eject button will be lit on the transport being tested, the test will not proceed any further, and one of the error messages shown below will be displayed.

**NO TAPE, RUNOFF, DATA PROTECTED, FAIL
WRITE FAIL, STALL, or END OF TAPE**

These messages are explained in the 2641A/2645A/S *User's Manual*.

If a hardware failure has occurred during the self-test, the reliability of the station cannot be assured. If any error occurred, press  to restore normal operation. Try replacing the tape cartridge and running the self-test again to make sure that the error is a hardware malfunction. Servicing procedures are contained in the *Service Manual*.

You may verify that the tapes you record may be used by other terminals as follows:

- Perform the tape transport test.
- Rewind the tapes.
- Exchange tape between the left and right transports.
- Read each tape, and check that a line of "%Z" appears on the screen. If this does not happen, a hardware malfunction may exist in one of the transports.

FROM COMPUTER. The tape transports may be tested from your program by coding:

ESC & p 1u 7C (for the left tape transport)
ESC & p 2u 7C (for the right tape transport)

After the test is performed, the terminal will respond with an "S" CR(LF) if the test was successful or an "F" CR(LF) if the test failed. The status of the tested tape unit may be interrogated to determine the reason for the failure. (See Section VI, "Status".)

DATA COMMUNICATIONS SELF-TEST

This self-test checks the data communications PCA (13260A, B, C or D) and the associated network cabling. Test connectors are used with the self-test function to provide signal loop-back while the internal diagnostic is being run. A description of the test connectors is provided in table 7-14. To run the self-test, follow the instructions in table 7-15 or 7-16, whichever is applicable. Flowcharts of the self-test are contained in figures 7-33 and 7-34.

Table 7-14. Data Communications Self-Test Connectors


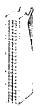

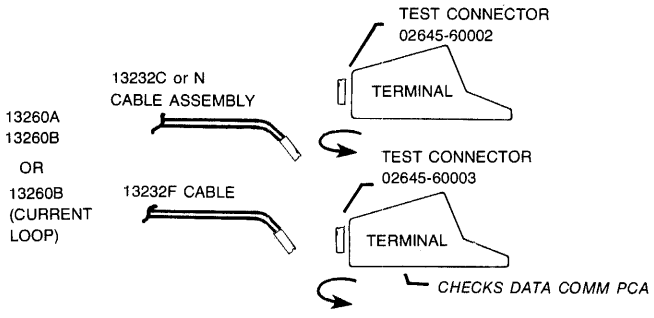
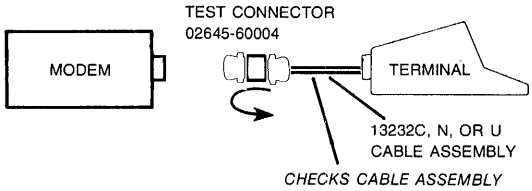
SELF-TEST CONNECTORS	HP PART NO.	USED FOR
	02645-60002	Checks RS232 circuits on 13260A, B, C, D accessory PCA's. (Does not check multipoint circuits on PCA; use 02645-60004 test connector below.)
	02645-60003	Checks current loop circuits on 13260B accessory PCA.
	02645-60004	Provides loop-back of RS232 signals at RS232 connector end of cable. Used during self-test of multipoint configurations.

Table 7-15. Point-to-Point Data Communications Self-Test Procedure

<p>STEP 1.</p> <p>a. Ensure power is off, and disconnect cable data communications PCA.</p> <p>b. Connect PCA Test Connector, part no. 02645-60002, to data communications PCA. (If operating in current loop, use test connector part no. 02645-60003 to connect to 13260B Data Communications PCA.)</p> <p>c. Turn on power, and press <input type="button" value="GREEN"/>, <input type="button" value="ENTER"/> (see note).</p> <p>d. Refer to data comm self-test flowcharts for diagnosing possible error messages.</p>	
<p>STEP 2.</p> <p>a. Turn off power, and connect 13232C or N Cable Assembly to 13260A, B, C, or D data communications PCA. (If operating in current loop, connect 13232F cable to 13260B data communications PCA.)</p> <p>b. Connect RS232 Test Connector, part no. 02645-60004, to RS232 connector on 13232C or N cable.</p> <p>c. Turn on power, and press <input type="button" value="GREEN"/>, <input type="button" value="ENTER"/> (see note).</p> <p>d. Refer to data comm self-test flowcharts for diagnosing possible error messages.</p>	
<p>NOTE: For terminals without cartridge tapes, use ESC x to perform data comm self-test.</p>	

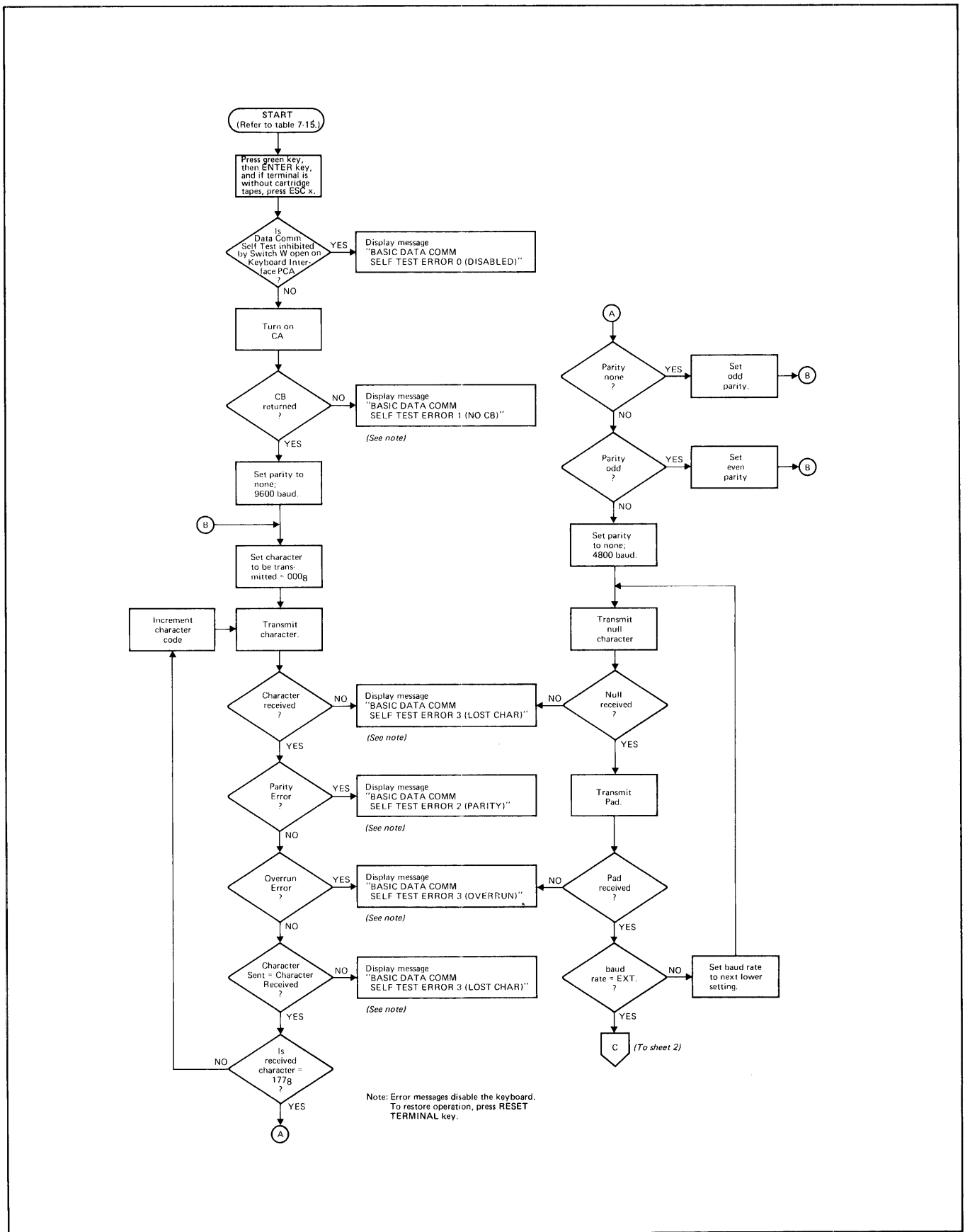


Figure 7-33. Basic Data Comm Self-Test Flowchart (Sheet 1 of 2)

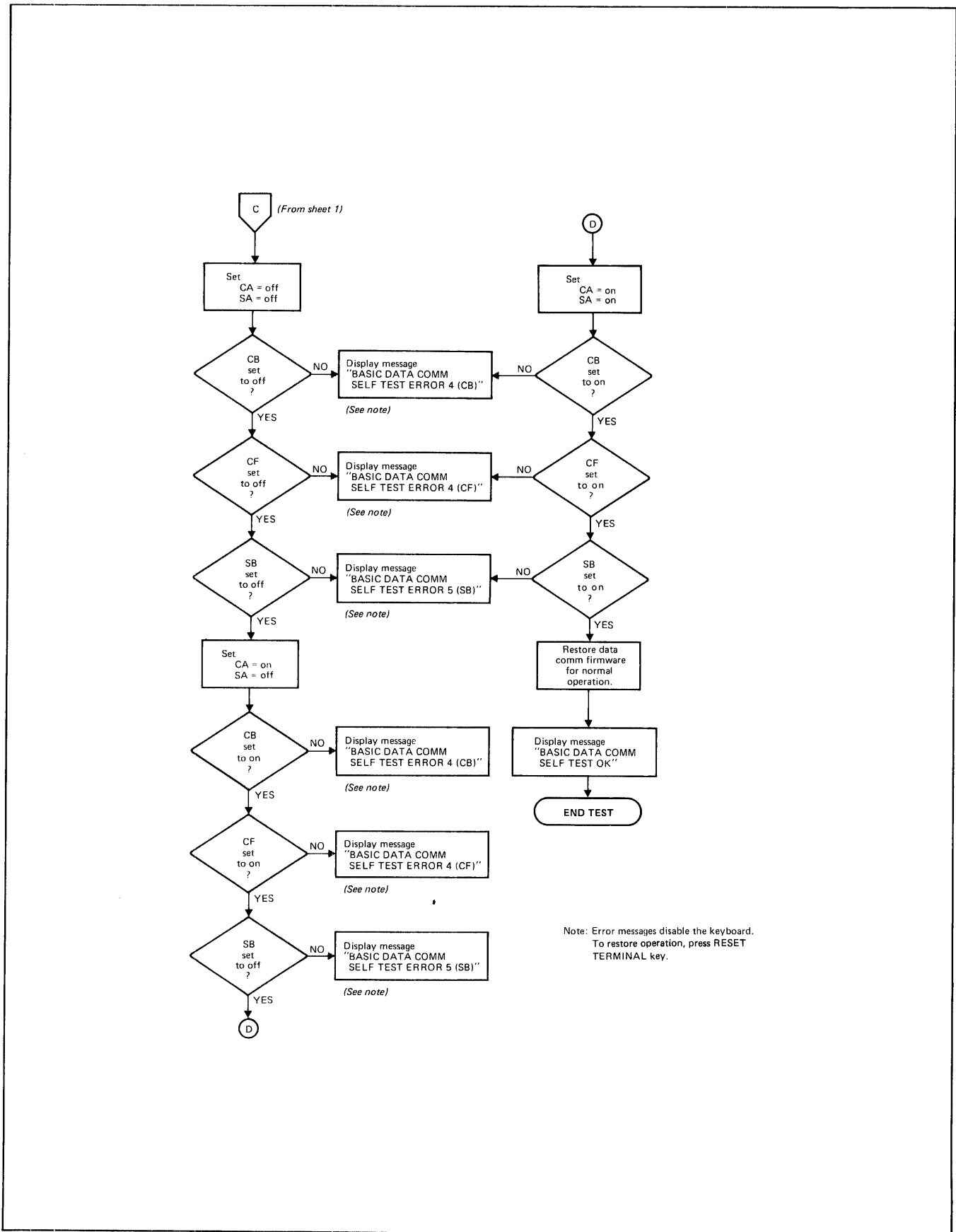
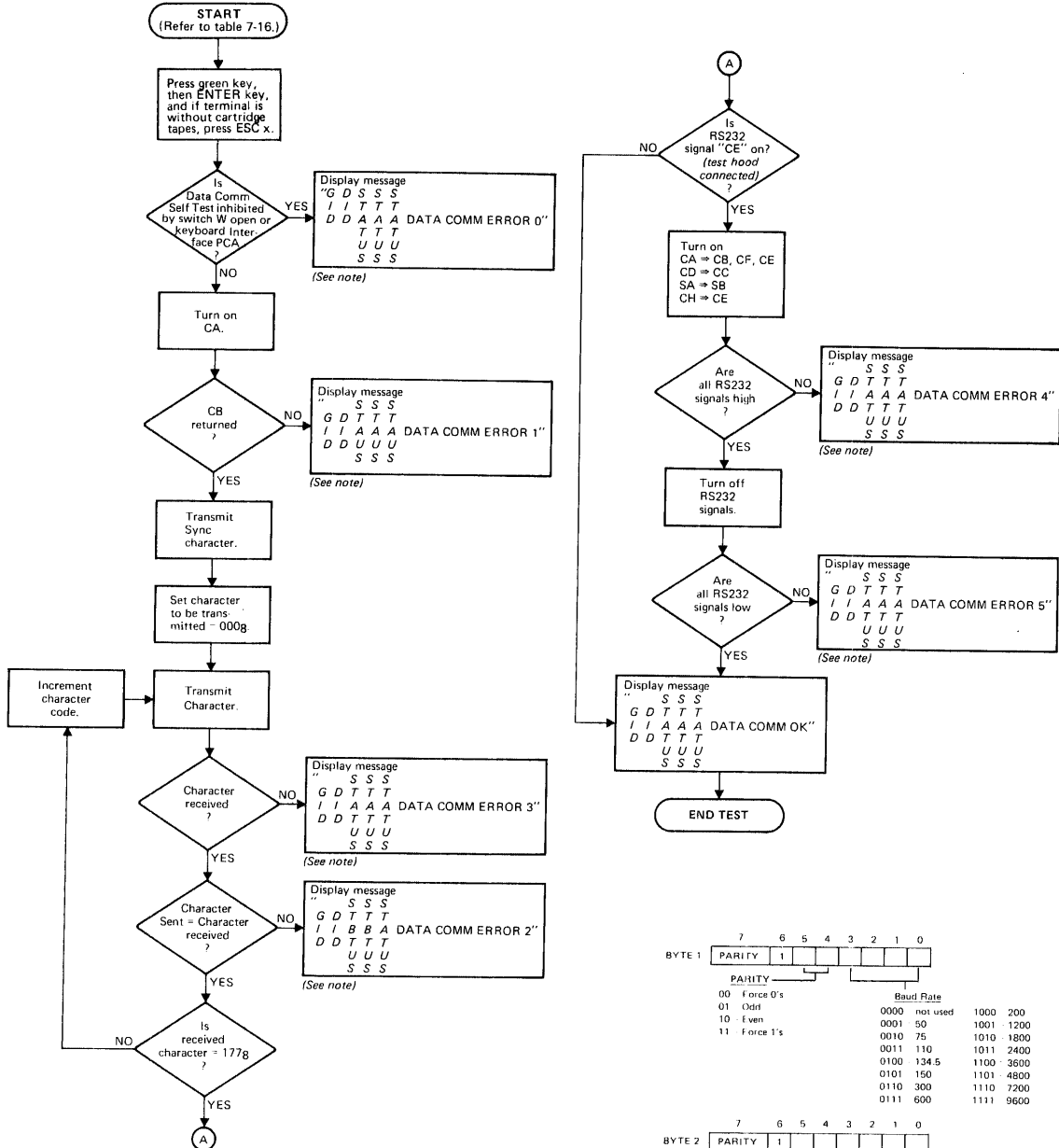


Figure 7-33. Basic Data Comm Self-Test Flow chart (Sheet 2 of 2)

Table 7-16. Multipoint Data Communications Self-Test Procedure

<p>STEP 1.</p> <ol style="list-style-type: none"> Ensure power is off, and disconnect cable from 13260C or D communications PCA. Connect PCA Test Connector, part no. 02645-60002, to 13260C or D data communications PCA. Turn on power, and press <input type="button" value="GREEN"/> , <input type="button" value="ENTER"/> (see note). Refer to multipoint data comm self-test flowchart for diagnosing possible error messages. 	<p style="text-align: center;">DATA COMM TESTING (MULTIPOINT)</p>
<p>STEP 2.</p> <ol style="list-style-type: none"> Turn off power, and reconnect cable to 13260C or D data communications PCA. Connect RS232 Test Connector, part no. 02645-60004, to RS232 connector on 13232P cable. Turn on power, and press <input type="button" value="GREEN"/> , <input type="button" value="ENTER"/> (see note). Refer to multipoint data comm self-test flowchart for diagnosing possible error messages. 	<p style="text-align: center;">CHECKS OPTICAL ISOLATORS ON DATA COMM PCA</p>
<p>STEP 3.</p> <ol style="list-style-type: none"> Turn off power, and connect 13232P cable to modem. Switch modem to loop-back mode (if possible). Turn on power, and press <input type="button" value="GREEN"/> , <input type="button" value="ENTER"/> (see note). If self-test did not pass, the modem may be malfunctioning. Refer to multipoint data comm self-test flowchart for diagnosing possible error messages. 	<p style="text-align: center;">CHECKS NEAR-END MODEM</p>
<p>STEP 4.</p> <ol style="list-style-type: none"> Switch modem back to normal operation. Switch far-end modem to loop-back mode (if possible). Turn on power, and press <input type="button" value="GREEN"/> , <input type="button" value="ENTER"/> (see note). If self-test did not pass, the modem may be malfunctioning. Refer to multipoint data comm self-test flowchart for diagnosing possible error messages. 	<p style="text-align: center;">CHECKS FAR-END MODEM</p>
<p>NOTE: For terminals without cartridge tapes, use ESC x to perform data comm self-test.</p>	



Note 1. Error messages disable the keyboard. To restore operation, press RESET TERMINAL key.

Note 2. Display Message Legend.

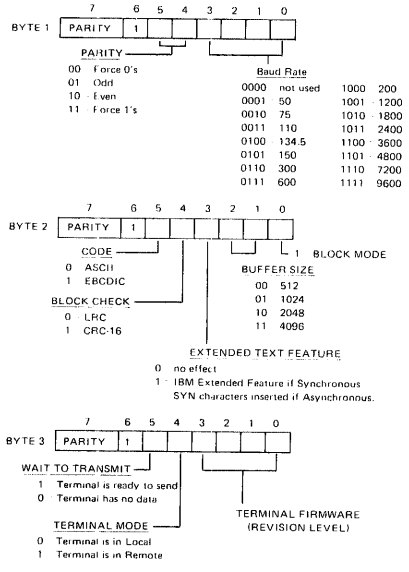
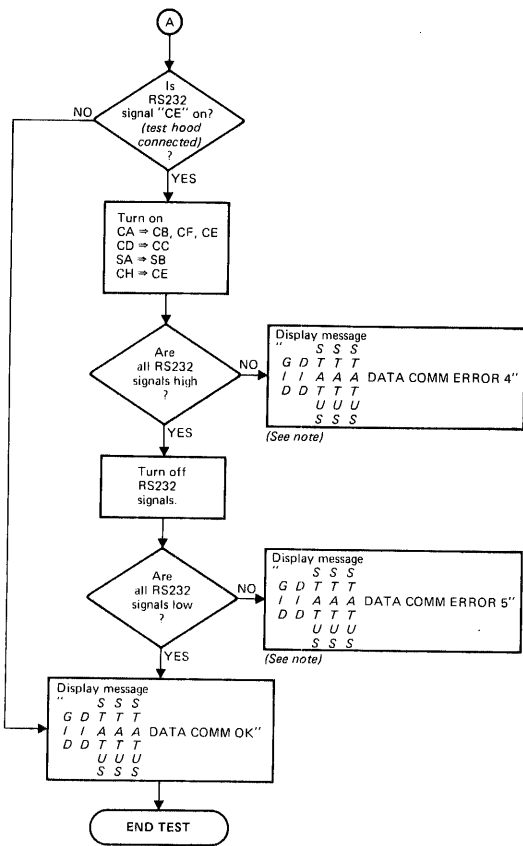
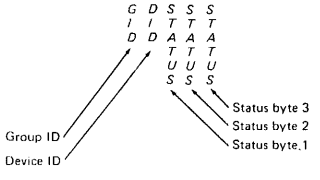


Figure 7-34. Multipoint Data Comm Self-Test Flowchart

HP 2641A DISPLAY STATION DIFFERENCES

Installation procedures for the HP 2645A are followed when installing the HP 2641A. However, the differences are described as follows:

- a. The HP 13231A Display Enhancement is standard. However, only one alternate set can be installed at a time.
- b. Figure 7-35 shows the jumper and ROM socket locations for the Display Enhancement PCA.
- c. The second Control Memory PCA jumper and ROM socket configuration is shown in figure 7-36.
- d. Figure 7-37 shows the HP 13261A Device Support Firmware IC locations on the Control Memory PCA. Perform the procedure for "13261A Device Support Firmware," except use ROM IC 1818-0274 instead of 1818-0211.
- e. Additional strapping options for the Keyboard Interface PCA point-to-point and multipoint operation are given below.
- f. Basic self-test patterns for the HP 2641A are given in figure 7-38.

STRAP	STRAPPING OPTION	NORMAL OPERATION (SWITCH CLOSED)	OPERATION WITH STRAPPING OPTION (SWITCH OPEN)
P	APL Printer Pairing Code	Makes terminal compatible with APL Printers with bit-pairing codes.	Makes terminal compatible with APL Printers with typewriter-pairing codes.

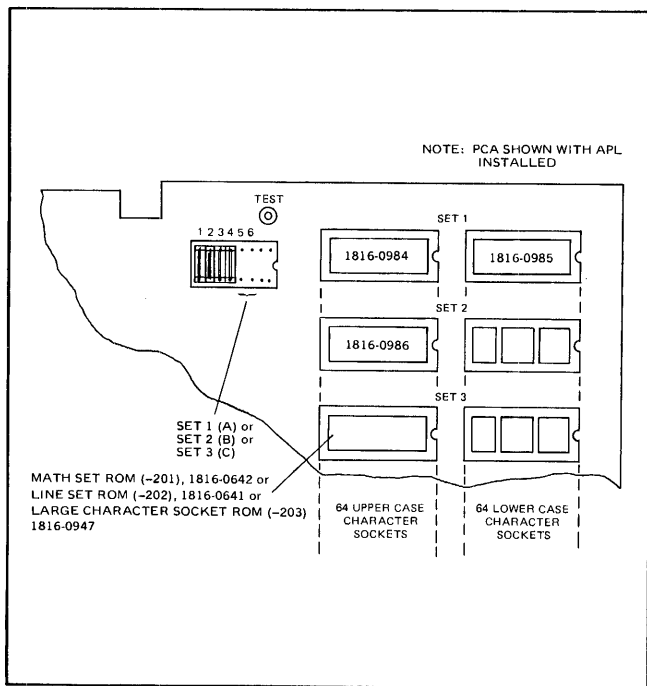


Figure 7-35. Display Enhancement PCA Jumper and ROM Socket Locations (HP 2641A)

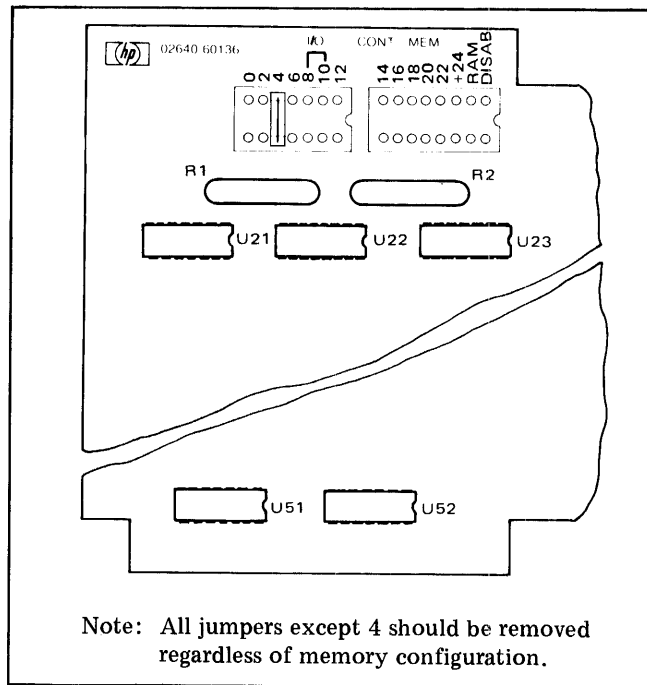


Figure 7-36. Second Control Memory PCA Jumper Configurations (HP 2641A)

HP 2645S DISPLAY STATION DIFFERENCES

Installation procedures for the HP 2645A are followed when installing the HP 2645S. However, the differences are described as follows:

- a. To upgrade the standard 64 character set to 128 characters, use ROM IC, part no. 1816-0865, and refer to paragraph "64 Character Lower Case ROM" for installation procedures.
- b. Basic self-test patterns for the HP 2645S are given in figure 7-39.

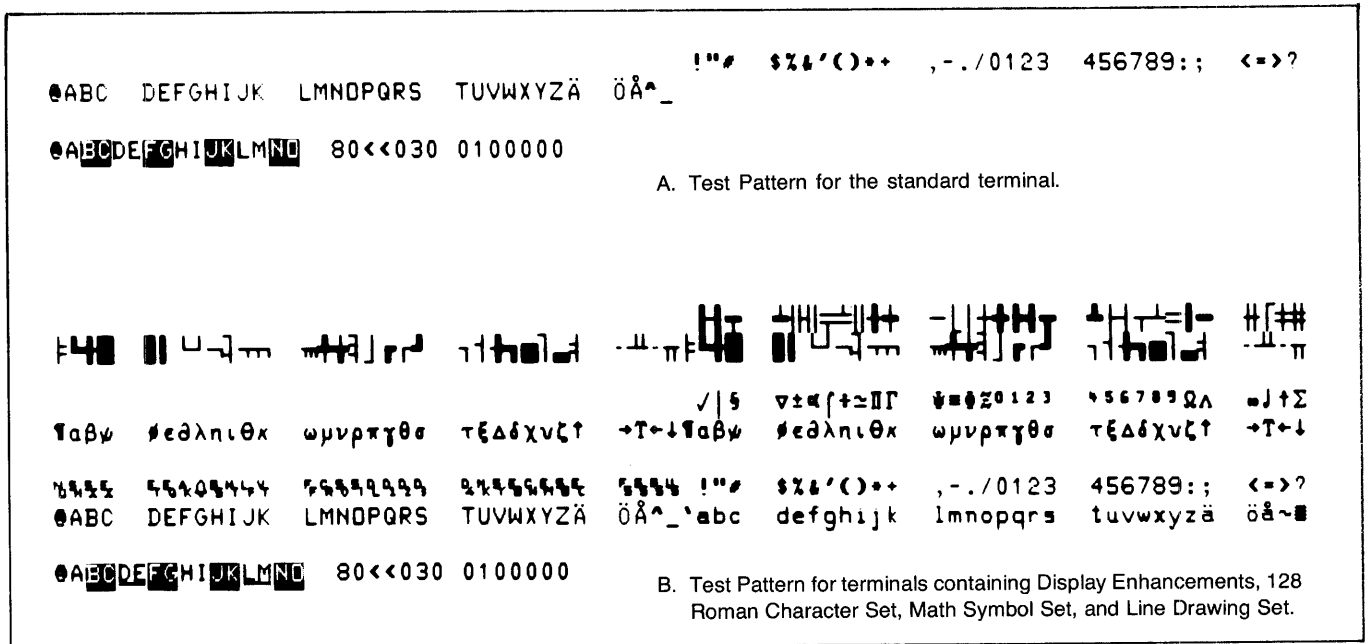


Figure 7-39. Basic Self-Test Patterns (HP 2645S)

INTRODUCTION

This appendix contains sample applications using the terminal's unique features. They can be used as a guide in developing your own applications.

MULTIPOINT EXAMPLE

Suppose we have a group of terminals set up in a synchronous multipoint configuration. We wish to determine status of the left cartridge of the terminal with group ID D and device ID A.

We wish to send the printer status query escape sequence to terminal DA. In multipoint, this requires selecting that terminal first. Send the select sequence

```

S S S E P S S S S           E P
Y Y Y O A Y Y Y Y           N A
N N N T D N N N N   d d A A Q D
                    Lower Upper
                    Case  Case

```

Note the sync characters present before and after the EOT PAD (there must be at least 3 in both places). Turn the line around to receive (multipoint is half duplex) and the terminal will send an ACK0 to indicate it is ready to receive:

```

S S S S D
Y Y Y Y L 0
N N N N E

```

Turn around the line again and give the terminal the cartridge status request embedded in the appropriate protocol characters:

```

S S S S E           E B P
Y Y Y T S & p 1 ^   T C A
N N N X C           X C D

```

The terminal returns an ACK1 after the next turnaround

```

S S S S D
Y Y Y Y L 1
N N N N E

```

if the data was OK and a NAK

```

S S S S N
Y Y Y Y A
N N N N K

```

if not. In the latter case retransmit the escape sequence above; either a parity error occurred or the BCC is wrong. Check that the proper parity is selected on the keyboard switch and the proper BCC is strapped on the data comm card.

To receive the printer status, poll terminal DA: send

```

S S S E P S S S S           E P
Y Y Y O A Y Y Y Y           N A
N N N T D N N N N DD AA Q D

```

After turnaround, you may receive from the terminal

```

S S S S E
Y Y Y Y O
N N N N T

```

This means the terminal is not yet ready to send status. Poll again until you receive it:

```

S S S S S           E           E B
Y Y Y Y T           S           C L G T C
N N N N X DA C/P 021 R F S X C

```

You should check the BCC the terminal sends to assure the integrity of the data.

If it checks and no parity errors were detected, send the terminal an ACK1 after you turn the line around:

```

S S S S D
Y Y Y Y L 1
N N N N E

```

After flipping to receive mode, the program will get:

```

S S S S E
Y Y Y Y O
N N N N T

```

from the terminal indicating it has no more data to send for the moment. Now the program may examine the status byte to glean whatever information it desires from them.

Applications

If the data comm had been asynchronous, the procedure would be identical except that the sync characters are not required to be sent to the terminal (although doing so is harmless) and no sync headers would be sent by the terminal (unless strap J05 were open). So except for hardware considerations, the process flows in much the same fashion in both communication methods.

Incidentally, the programmer would not normally need to perform such tasks as turning the communication lines from send to receive and vice versa, placing the STX, ETX framing characters on the messages, calculating BCC or sending select and poll sequences. At the higher level, the program simply makes output and input statements. However, this example indicates the complete process that occurs for such a two-way communication as a status request. Transactions like cursor sensing would follow exactly the same lines; only escape sequences specific to the operation differ.

FORMS BUILDING















Special purpose forms can be built using the terminals alternate character sets and data fields. The following technique builds forms in three phases using the soft keys and tape cartridges.

- Phase 1 — Outline the form and define protected/unprotected fields.
- Phase 2 — Detail the form.
- Phase 3 — Assign field checking parameters and record the form.

This example uses one tape cartridge to hold codes to be assigned to the soft keys. A second tape cartridge is used to hold the completed form. This example assumes that the Line Drawing character set is in position "C".

PROGRAMMING THE SOFT KEYS

Figures A-1 through A-3 show the escape sequences required to program the soft keys for each of the phases of form building. To record the escape sequences on the first tape cartridge, proceed as follows:

1. Press   (or Esc j).
2. Program each key as shown in figure A-1. Mark a key overlay.
3. Place a tape cartridge in the right tape slot.
4. Press  (Esc & pF). This stores phase 1 key assignments in file 1 on the tape.
5. Press  ,  ,  .
6. Program the keys for phase 2 as shown in figure A-2.
7. Press  (Esc & pF). Press  ,  ,  . This stores phase 2 key assignments in file 2.
8. Program the keys for phase 3 using figure A-3.
9. Press  (Esc & pF).
10. Press  ,  ,  (Esc & p2u0C). After the tape is rewound, remove the tape.

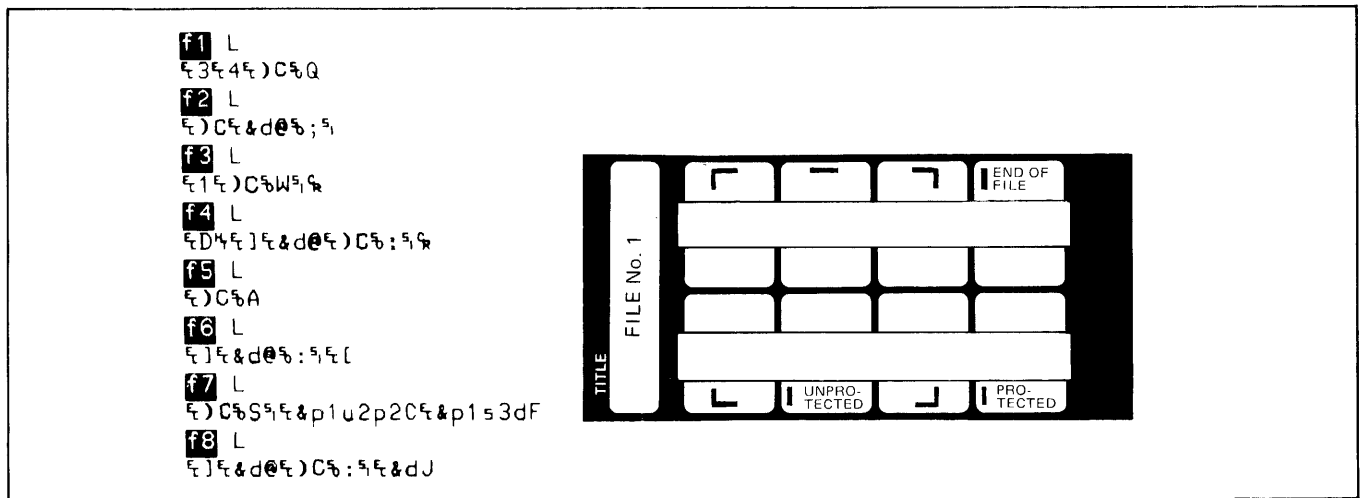


Figure A-1. Soft Key Programming and Soft Key Overlay for File 1

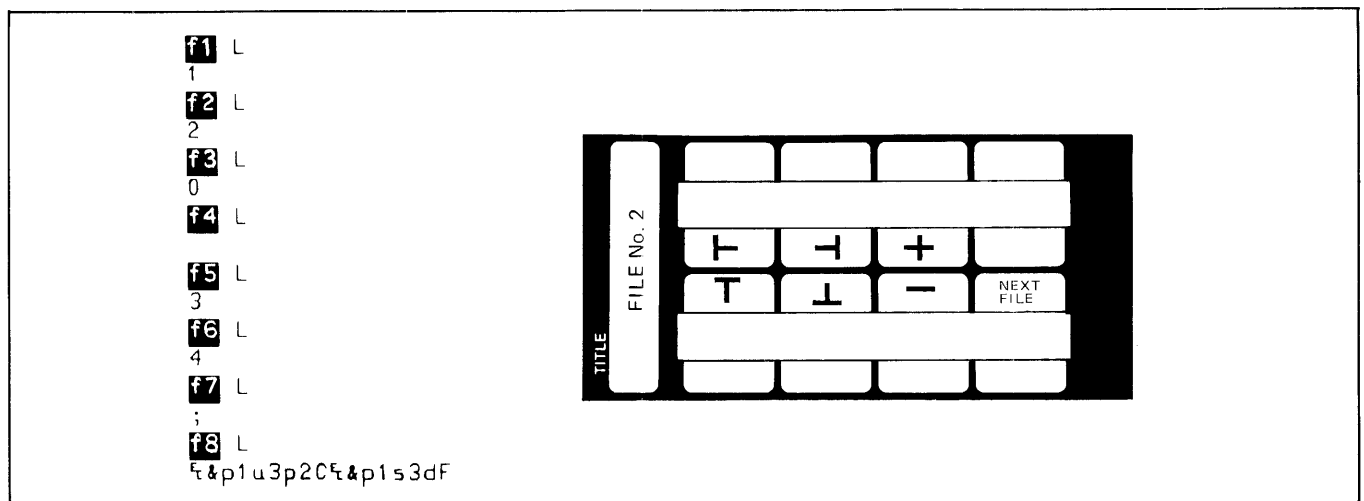


Figure A-2. Soft Key Programming and Soft Key Overlay for File 2

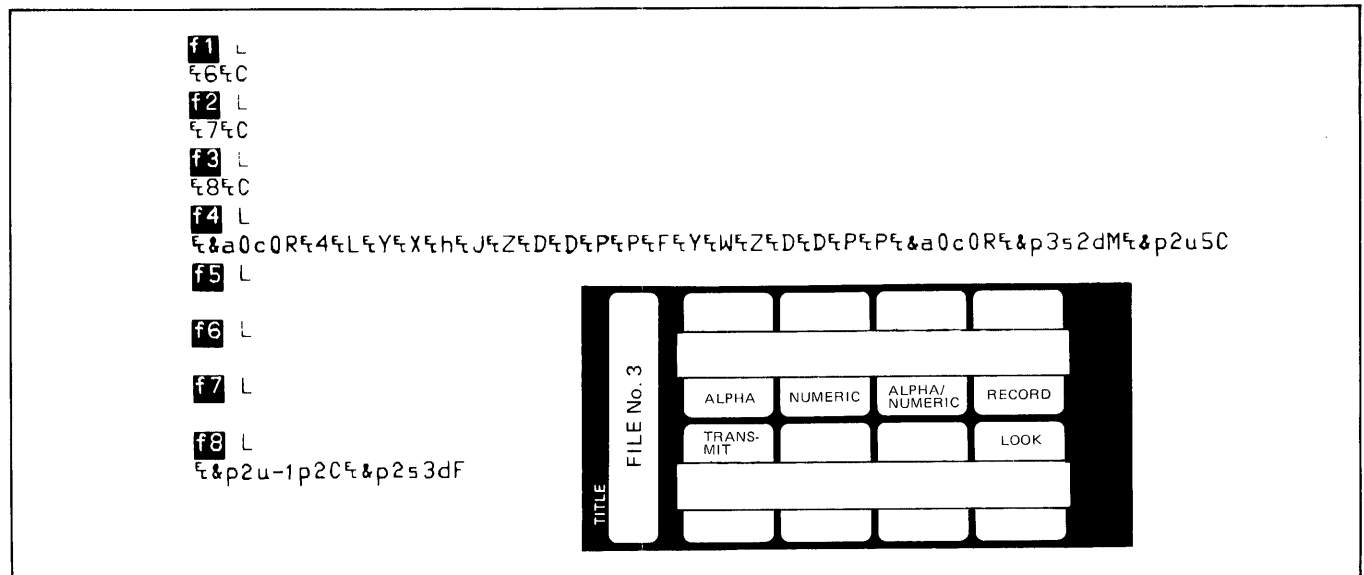


Figure A-3. Soft Key Programming and Soft Key Overlay for File 3

BUILDING THE FORM

Figure A-4 contains a simple form which will be used as an example. Insert your soft key program tape cartridge into the left tape slot and a blank tape cartridge into the right tape slot. Make sure that the device assignments are "from" left tape and "to" right tape. Forms can now be built as follows:

PHASE 1.

1. Press READ. This loads the soft keys with file 1. Place the soft key overlay for file 1 over the soft keys.
2. Starting at the top left of your form, proceed to build your form — left to right — top to bottom. The soft key overlay will help you by giving the function of each key. Figure A-5 shows the details of building the sample form line-by-line during the first phase. The field headings (Name, Address, etc.) are "protected", and the fields to be filled by an operator are "unprotected".

After the length of the first line is defined (the top of the form), the cursor automatically tabs to the end of the first line when the END OF LINE key (f4) is pressed.

When the **▲** (f7) key is pressed (finishing the outline phase of the form), file 2 is automatically read to load the soft keys for phase 2.

Name			
Address	State		ZIP
Telephone			

Figure A-4. Sample Form

PHASE 2.

1. Place the soft key overlay for file 2 over the soft keys.
2. Move the cursor to each line intersection, and press the appropriate soft key. Figure A-6 shows the soft key used at each line intersection in the sample form.
3. When you have finished with the line intersection, press NEXT (f8). This will automatically load the soft keys with file 3.

PHASE 3.

1. Place the soft key overlay for file 3 over the soft keys.
2. Starting at the top of the form, move the cursor to beginning of the first unprotected field. (In this case, it would be where the operator will fill in the name.) Pressing ALPHA (f1), defines the first space as an alpha-only field. You should press f1 as many times as necessary to fill the name field. This will prevent numbers from being entered erroneously in this field.
3. Move the cursor to the beginning of each of the remaining unprotected fields, and define each as ALPHA, NUMERIC, ALPHANUMERIC, or undefined, as applicable. Figure A-7 shows the definition of each field.
4. After each field has been defined, the form is complete. Now, press RECORD (f4) to store the form on the right tape cartridge. LOOK (f8) can be used to recall the form from the right tape cartridge to insure that it has been recorded correctly.

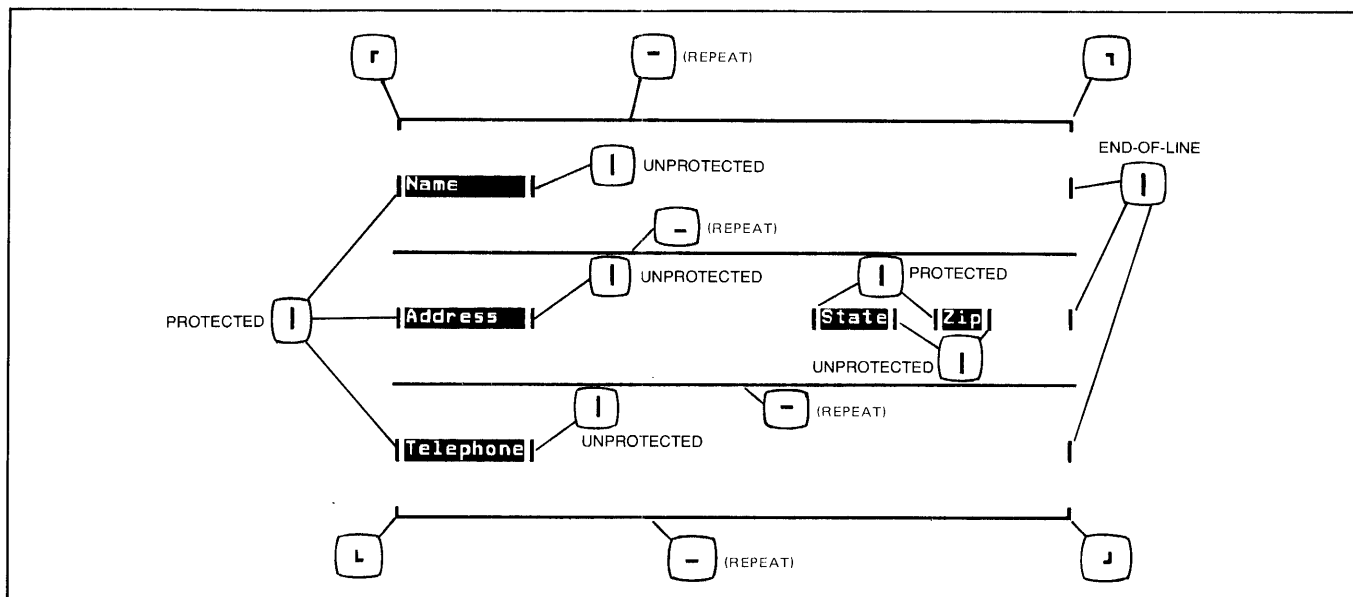


Figure A-5. Building a Form — Phase 1

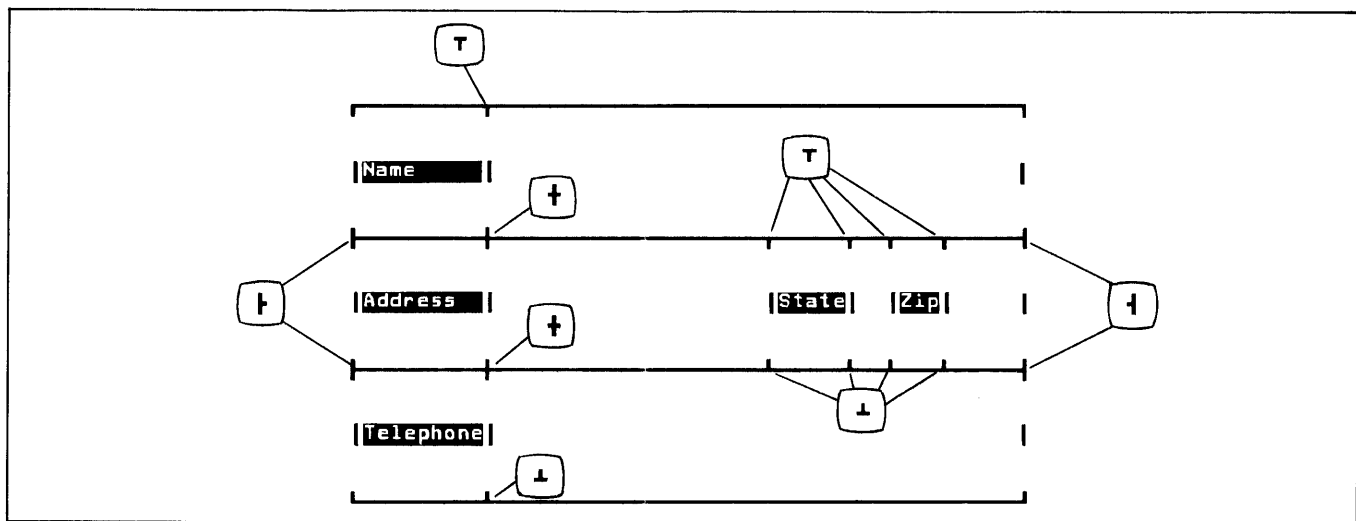


Figure A-6. Building a Form — Phase 2

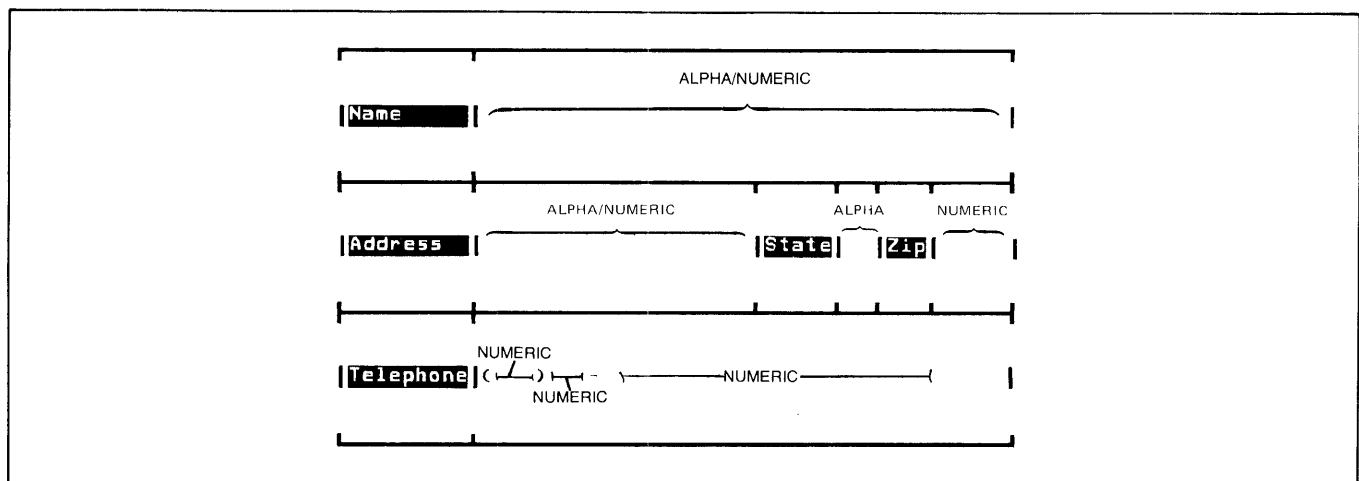


Figure A-7. Building a Form — Phase 3

LARGE CHARACTER SET UTILITY

Since using the Large Character Set requires using up to nine character codes for each large character, it is desirable to use a utility program. A sample utility program is given in figure A-8. The program is written BASIC/3000 but can be adopted for use in other languages. The utility accepts an entire line or string of characters and generates the necessary codes to generate the entire line in Large Characters.

```

9000 REM SUBROUTINE TO PRINT STRING IN L1$ IN LARGE CHAR. SET
9010 REM USES VARIABLES L1$ THRU L4$, L1 THRU L3
9020 DIM L1$(26),L2$(11),L3$(128,9),L4$(1)
9030 IF UND(L1)=1 THEN DO
9040 PRINT CTL(208);'27")C";
9050 L3$(33)=" 0 E E "
9060 L3$(34)=" ## "
9070 L3$(35)="C&C0 0C&C"
9080 L3$(36)="!C+GC+GCL"
9090 L3$(37)="^ #3<DE ^"
9110 L3$(38)=" * & 4 "
9100 L3$(39)=" E "
9120 L3$(40)="!& 0 G& "
9130 L3$(41)=" &+ 0 &L"
9140 L3$(42)=" ( K "
9150 L3$(43)=" C "
9160 L3$(44)=" L "
9170 L3$(45)=" & "
9180 L3$(46)=" E "
9190 L3$(47)=" #3<DE "
9200 L3$(48)="!&+0 0G&L"
9210 L3$(49)=" - 0 E "
9220 L3$(50)="!&+!&LF&,"
9230 L3$(51)="!&+&0G&L"
9240 L3$(52)=" #F&C E"
9250 L3$(53)='34"&,F&+G&L"
9260 L3$(54)="!&+/&+G&L"
9270 L3$(55)="%">D E "
9280 L3$(56)="!&+5&0G&L"
9290 L3$(57)="!&+G&?G&L"
9300 L3$(58)=" E E "
9310 L3$(59)=" E L "
9320 L3$(60)=" 3 2 "
9330 L3$(61)=" & & "
9340 L3$(62)=" ) D "
9350 L3$(63)="!&+>D V "
9360 L3$(65)="!&+/&?E E"
9370 L3$(66)='34"&+/&0F&L"
9380 L3$(67)="!&+0 G&L"
9390 L3$(68)='34"&+0 0F&L"
9400 L3$(69)='34"&,/& F&,"
9410 L3$(70)='34"&,/& E "
9420 L3$(71)="!&+0 .G&L"
9430 L3$(72)=" #/&?E E"
9440 L3$(73)=" / 0 I "
9450 L3$(74)=" # 0G&L"
9460 L3$(75)=" #/6AE E"
9470 L3$(76)=" # 0 F&,"
9480 L3$(77)="$( -070E E"
9490 L3$(78)="$( )#08BE E"
9500 L3$(79)='34"&.0 0F&M"
9510 L3$(80)='34"&+/&LE "
9520 L3$(81)="!&+0 0G&N"
9530 L3$(82)='34"&+/&0E E"
9540 L3$(83)="!&+G&+G&L"
9550 L3$(84)="%"', 0 E "
9560 L3$(85)=" # 0 0G&L"
9570 L3$(86)=" # 0 02JD"
9580 L3$(87)=" # 090HKD"
9590 L3$(88)=" # 1;AE E"
9600 L3$(89)=" # 2;D E "
9610 L3$(90)='34"&.3<DF&M"
9620 L3$(91)='34"& 0 F& "
9630 L3$(93)=" &. 0 &M"
9640 L3$(95)=" &&&"
9650 DDEND
9660 FOR L1=1 TO LEN(L1$)
9670 L2=NUM(UPS$(L1$(L1,L1)))
9680 IF L3$(L2)="" THEN PRINT CTL(208);'27"&a+3C";
9690 ELSE DO
9700 PRINT CTL(208);'14+L3$(L2,1,3)+'27"&a-3c+1R"+'14+L3$(L2,4,6)+'&
'27"&a-3c+1R"+'14+L3$(L2,7,9)+'27"&a-2R";
9710 DDEND
9720 NEXT L1
9730 PRINT CTL(208);'27"&a+3R"'13'10;
9740 RETURN

```

Figure A-8. Large Character Set Utility Routine

REFERENCE TABLES

APPENDIX

B

INTRODUCTION

This appendix contains the following reference information for each model terminal covered by this manual:

- Programmer's Reference Table
- Character Code Chart
- Special Symbols Tables (as applicable)

- List of Options and Accessories
- List of Specifications

A Large Character Set coding table for forming characters is included at the end of this appendix.

Table B-1. Programmers Reference Table (2641A)

KEY or SWITCH	ESCAPE or CONTROL CODE	FUNCTION	KEY or SWITCH	ESCAPE or CONTROL CODE	FUNCTION
CHARACTER SET GROUP					
Alphabetical, numerical and symbol keys		Similar to typewriter keyboard	BLOCK MODE latching key	—	Block Mode: data displayed but not transmitted until requested; otherwise, terminal in Character Mode and data transmitted as typed.
TAB key	HT (I ^c)	Forward cursor to next tab position.	REMOTE latching key	—	Remote (on-line) operations; otherwise, off-line operation
TAB ^c or Back Space ^c	ESC i	Back tab	CAPS LOCK latching key	—	Upper-case alphabetical lock
LINE FEED key	J ^c	Move cursor down one line	APL key & indicator	ESC < (On) ESC > (Off)	Turns on APL Mode when lighted. Otherwise terminal is in TTY/ASCII mode.
CNTL (control) key	C	Used to generate ASCII control codes.	AUTO LF latching key	—	Line Feed with each terminal carriage return
BACK SPACE key	BS (H ^c)	Cursor left one space	ADDITIONAL FUNCTIONS		
RETURN key	CR (M ^c)	Return cursor to start of line; clears I/O operations, screen messages; abort Green key operations.	—	ENQ (E ^c)	Enquiry from the computer
^c Control key (CNTL) depressed at same time			—	ACK (F ^c)	Acknowledge — response to ENQ
NUMERICAL AND DISPLAY CONTROL GROUP			—	BEL (G ^c)	Bell
f1 key	ESC A	Cursor Up	—	ESC)	Define Alternate Character Set: (@, A, B, C)
j key	ESC B	Cursor Down	—	SO (N ^c)	Turn on Alternate Character Set
→ key	ESC C	Cursor Right	—	SI (O ^c)	Turn off Alternate Character Set
← key	ESC D	Cursor Left	—	DCI (Q ^c)	Block Transfer Trigger
^ key	ESC h	Cursor Home	—	DC2 (R ^c)	Block Transfer Enable from Terminal
^ c	ESC F	Cursor Home Down	—	ESC d	Block Transfer Enable from Computer
␣ ^c	ESC 5	Right Margin Set	—	RS (Λ ^c)	Record Separator
␣ ^c	ESC 4	Left Margin Set	—	US (_ ^c)	Unit Separator
CLEAR DSPLY key	ESC J	Clear memory from cursor position	—	ESC & a	Cursor Addressing
CLEAR DSPLY ^c	ESC K	Clear line from cursor	—	ESC a	Cursor Sensing (absolute)
ROLL UP key	ESC S	Scroll the display up one line	—	ESC \	Cursor Sensing (Relative)
ROLL DOWN key	ESC T	Scroll the display down one line	—	ESC _	Write Non-Displaying Terminator
NEXT PAGE key	ESC U	Display the next 24 lines of memory	—	ESC b	Keyboard Enable
PREV PAGE key	ESC V	Display the previous 24 lines of memory	—	ESC c	Keyboard Disable
NEXT PAGE ^c	ESC j (On) ESC k (Off)	Display User-Defined Soft Keys	—	ESC e	Fast Binary Read
SET TAB key	ESC 1	Set tab at the current cursor column	—	ESC f	Modem Disconnect
CLEAR TAB key	ESC 2	Clear a tab at the current cursor column	—	ESC 6	Alphabetic Only Field
CLEAR TAB ^c	ESC 3	Clear all tabs	—	ESC 7	Numeric Only Field
Ten-Key Numeric Group	—	Adding machine format keyboard	—	ESC 8	Alphanumeric Field
EDIT GROUP			—	ESC 8	Alphanumeric Field
INSERT LINE key	ESC L	Blank line inserted	—	ESC I	Tab
DELETE LINE key	ESC M	Line containing cursor deleted	—	ESC G	Cursor Return
Green INSERT LINE	ESC & p 9C	Turn-on tape Write-Backspace-Read Mode	—	ESC H	Home cursor (excluding transmit only fields)
Green DELETE LINE	ESC & p 10C	Turn-off tape Write-Backspace-Read Mode	—	ESC Λ	Terminal Status
INSERT CHAR key	ESC Q (On) ESC R (Off)	Succeeding inputs inserted at cursor	—	ESC ~	Extended Status Request
DELETE CHAR key	ESC P	Character at cursor deleted	—	ESC @	Delay one second
INSERT CHAR ^c	ESC N (On) ESC R (Off)	Line Wraparound Mode. Succeeding inputs inserted at cursor with wraparound to left margin of next line.	—	ESC (escape)	ESC (I ^c) Leads off an ASCII escape sequence
DELETE CHAR ^c	ESC O	Delete character with wraparound from left margin of next line.	—	ESC & b	HP Diagnostic ONLY
COMMUNICATIONS GROUP			—	ESC & f	Define User-Defined Soft Keys
DUPLEX SWITCH	—	Half/Full	—	ESC & g	Simulate PA, PF Keys
PARITY switch	—	Even/Off/None	—	ESC & k	Define Latching Keys
BAUD RATE switch	—	110, 150, 300, 1200, 2400, 4800, 9600 external	—	ESC I	Turn on memory lock
CONTROL GROUP			—	ESC m	Turn off memory lock
RESET TERMINAL key	ESC g	(First press) Free the keyboard and clears I/O operations	—	ESC & p	I/O Control Sequence
	ESC E	(Second press) Set the terminal to power-on state	—	ESC & s	Define Strap Settings
TEST key	ESC z	2641 Self-Test (no cartridges)	USER-DEFINED SOFT KEY GROUP		
TEST ^c	—	Conditions tapes	f1 key	ESC p	} Or up to 80-character user-defined sequence for each key (Display, transmit, or both)
GREEN TEST	—	2641 Self-Test (tests cartridges)	f2 key	ESC q	
DISPLAY FUNCTIONS key & indicator	ESC Y (On) ESC Z (Off)	Control functions disabled and displayed	f3 key	ESC r	
DISPLAY FUNCTIONS ^c	ESC y (On) ESC Z (Off)	Monitor Mode. Display all codes recorded from data comm lines.	f4 key	ESC s	
			f5 key	ESC t	
			f6 key	ESC u	
			f7 key	ESC v	
			f8 key	ESC w	

Data subject to change

Table B-1. Programmers Reference Table (2641A) (Continued)

KEY or SWITCH	ESCAPE or CONTROL CODE	FUNCTION	KEY or SWITCH	ESCAPE OR CONTROL CODE	FUNCTION																																																																																					
f ₁ f ₂ f ₃ f ₄ f ₅ f ₆	ESC & d ESC [ESC] ESC W (On) ESC X (Off) ESC {	<p>Turn on Display Enhancement:</p> <table border="1"> <tr> <td></td> <td>@</td> <td>A</td> <td>B</td> <td>C</td> <td>D</td> <td>E</td> <td>F</td> <td>G</td> <td>H</td> <td>I</td> <td>J</td> <td>K</td> <td>L</td> <td>M</td> <td>N</td> <td>O</td> </tr> <tr> <td>Half-Bright</td> <td></td> <td></td> <td></td> <td></td> <td></td> <td></td> <td></td> <td></td> <td>x</td> <td>x</td> <td>x</td> <td>x</td> <td>x</td> <td>x</td> <td>x</td> <td>x</td> </tr> <tr> <td>Under-line</td> <td></td> <td></td> <td></td> <td>x</td> <td>x</td> <td>x</td> <td>x</td> <td></td> <td></td> <td></td> <td></td> <td></td> <td>x</td> <td>x</td> <td>x</td> <td>x</td> </tr> <tr> <td>Inverse Video</td> <td></td> <td>x</td> <td>x</td> <td></td> <td></td> <td>x</td> <td>x</td> <td></td> <td></td> <td></td> <td>x</td> <td>x</td> <td></td> <td></td> <td>x</td> <td>x</td> </tr> <tr> <td>Blinking</td> <td>x</td> <td>x</td> <td>x</td> <td>x</td> <td>x</td> <td>x</td> <td>x</td> <td>x</td> <td>x</td> <td>x</td> <td>x</td> <td>x</td> <td>x</td> <td>x</td> <td>x</td> <td>x</td> </tr> </table> <p>Start Unprotected Field End Unprotected or Transmit-Only Field Format Mode. Protected fields can not be modified. Start Transmit - Only Field</p>		@	A	B	C	D	E	F	G	H	I	J	K	L	M	N	O	Half-Bright									x	x	x	x	x	x	x	x	Under-line				x	x	x	x						x	x	x	x	Inverse Video		x	x			x	x				x	x			x	x	Blinking	x	x	x	x	x	x	x	x	x	x	x	x	x	x	x	x	<p>L. TAPE REWIND f₅ GREEN f₅ or R. TAPE MARK FILE f₅ GREEN f₆ or L. TAPE SKIP LINE f₅ GREEN f₇ ± n or R. TAPE FIND FILE f₅ GREEN f₈ ± n or R. TAPE space f₆</p>	<p>ESC &p 10μ0C or ESC &p 2μ0C or ESC &p 1μ5C or ESC &p 2μ5C or ESC &p ±np1μ1C or ESC &p ±np2μ1C or ESC &p (±)np1μ2C or ESC &p (±)np 2μC</p>	<p>Rewinds LEFT TAPE or RIGHT TAPE Write a FILE MARK on LEFT TAPE or RIGHT TAPE Positions selected cartridge ±n records Positions selected cartridge to (-)n files Display file, inches remaining for each tape.</p>
	@	A	B	C	D	E	F	G	H	I	J	K	L	M	N	O																																																																										
Half-Bright									x	x	x	x	x	x	x	x																																																																										
Under-line				x	x	x	x						x	x	x	x																																																																										
Inverse Video		x	x			x	x				x	x			x	x																																																																										
Blinking	x	x	x	x	x	x	x	x	x	x	x	x	x	x	x	x																																																																										
DATA PATH GROUP																																																																																										
<p>READ key READ^c GREEN READ^c RECORD key ENTER key GREEN ENTER TRANSMIT indicator BREAK key GOLD f₁ L TAPE GOLD f₂ R. TAPE GOLD f₃ DISPLAY GOLD f₅ L. TAPE GOLD f₆ R. TAPE GOLD f₇ DISPLAY GOLD f₈ PRINTER</p>	<p>— — — — ESC x — — ESC & p1S ESC & p2S ESC & p3S ESC & p1D ESC & p2D ESC & p3D ESC & p4D</p>	<p>One file transferred from selected source device to display (LOCAL) or transmitted (REMOTE) Read page without DC handshake Read tape beyond end-of-data mark One file from the display (LOCAL) or data received (REMOTE) transferred to selected printer, display and/or tape Same as RECORD (LOCAL) or enables block transfer (REMOTE) Data Comm Self-Test Data Link Exists Transmit BREAK signal to interrupt computer Assign LEFT TAPE as source Assign RIGHT TAPE as source Assign DISPLAY as source Assign LEFT TAPE as destination Assign RIGHT TAPE as destination Assign DISPLAY as destination Assign PRINTER as destination</p>	<p style="text-align: center;">MAINFRAME REAR PANEL SWITCHES</p> <p>PWR ON/OFF switch — Primary power to terminal</p> <p>Alternative Strappable Functions:</p> <ul style="list-style-type: none"> • Function key transmission • Space overwrite (SPOW) latch enable • Cursor end-of-line wraparound • Block mode, page • Paper tape mode • Fast Binary read • Block transfer handshake • Eliminate block handshake • ENTER inserts terminator automatically • Reverse effect of CNTL on Insert Delete Char. • Send display codes to printer • Self test inhibit • Delete terminator after transmission • Set code translate table for bit paired or typewriter paired printer <p>Status Information: memory size, strap settings, latching keys, transfer pending flags, error condition flags, device status, terminal type, data comm. status.</p>																																																																																							
<p>NOTE: One source and multiple destinations can be set up with the same sequence. Example: GOLD f₁ f₇ f₈ L. TAPE DISPLAY PRINTER ESC &p 1s3d 4D</p>																																																																																										
<p>COPY ALL GREEN f₁ COPY FILE GREEN f₂ COPY LINE GREEN f₃ GREEN f₁^c or f₂^c or f₃^c EDIT GREEN f₄</p>	<p>ESC &pM ESC &pF ESC &pB ESC &p 1M ESC &p 1F ESC &p 1B —</p>	<p>All data (current source position) from source transferred to destination One file (current source position) from source transferred to destination One line (current source position) from source transferred to destination Compare data between source and destination Toggle EDIT mode to provide automatic data logging. Lines of data transferred to destination(s) or as deleted from top of memory.</p>																																																																																								

Table B-2. Character Code Chart (2641A)

BIT 7 6 5 4321	CONTROL (CNTL) CHARACTERS				DISPLAYABLE CHARACTERS				CNTL (ESCAPE) PRESSED FIRST						
	0000	0001	0010	0011	0100	0101	0110	0111	1000	1001	1010	1011	1100	1101	1110
0000	NUL	DLE	SP	@	P	\	p	SP	0	@	P	CURSOR RELATIVE SENSE	f ₁		
0001	SOH	DC1	!	1	A	Q	a	!	1	A	Q	CURSOR ABSOLUTE SENSE	f ₂	a	q
0010	STX	DC2	"	2	B	R	b	"	2	B	R	KEYBOARD ENABLE	f ₃	b	r
0011	ETX	DC3	#	3	C	S	c	#	3	C	S	KEYBOARD DISABLE	f ₄	c	s
0100	EOT	DC4	\$	4	D	T	d	\$	4	D	T	ENTER	f ₅	d	t
0101	ENQ	NAK	%	5	E	U	e	%	5	E	U	BINARY READ	f ₆	e	u
0110	ACK	SYN	&	6	F	V	f	&	6	F	V	MODEM DIS- CONNECT	f ₇	f	v
0111	BEL	ETB	'	7	G	W	g	'	7	G	W	SOFT RESET	f ₈	g	w
1000	BS	CAN	(8	H	X	h	(8	H	X	HOME CURSOR (SEE NOTE 3)		h	x
1001	HT	EM)	9	I	Y	i)	9	I	Y	BACK TAB		i	y
1010	LF	SUB	*	:	J	Z	j	*	:	J	Z	SOFT KEY DISPLAY ON		j	z
1011	VT	ESC	+	;	K	[k	+	;	K	[START XMIT ONLY FIELD		k	{
1100	FF	FS	,	<	L	\	l	,	<	L	\	MEMORY LOCK ON		l	
1101	CR	GS	-	=	M]	m	-	=	M]	MEMORY LOCK OFF		m	}
1110	SO	RS	.	>	N	^	n	.	>	N	^	SEND SECOND- ARY STATUS		n	~
1111	SI	US	/	?	O	_	o	/	?	O	_	DEL		o	DEL

Example: J is bits 1001010; Control J is LF line feed; Escape (⌘) followed by J is CLEAR DISPLAY

LEGEND

- | | | |
|-----------------------|--------------------------------|---------------------------|
| AK — ACKNOWLEDGE | EM — END OF MEDIUM | NK — NEGATIVE ACKNOWLEDGE |
| BEL — BELL | EQ — ENQUIRY | RS — RECORD SEPARATOR |
| BS — BACKSPACE | ET — END OF TRANSMISSION | SI — SHIFT IN |
| CN — CANCEL LINE | EC — ESCAPE | SO — SHIFT OUT |
| CR — CARRIAGE RETURN | EB — END OF TRANSMISSION BLOCK | SP — SPACE |
| D1 — DEVICE CONTROL 1 | EX — END OF TEXT | SH — START OF HEADING |
| D2 — DEVICE CONTROL 2 | FF — FORM FEED | SX — START OF TEXT |
| D3 — DEVICE CONTROL 3 | FS — FILE SEPARATOR | SB — SUBSTITUTE |
| D4 — DEVICE CONTROL 4 | GS — GROUP SEPARATOR | SY — SYNCHRONOUS IDLE |
| DEL — DELETE | HT — HORIZONTAL TABULATION | US — UNIT SEPARATOR |
| DL — DATA LINK ESCAPE | LF — LINE FEED | VT — VERTICAL TABULATION |

NOTES: 1. LOWER CASE LETTER, LOWER CASE SYMBOL, AND CONTROL CHARACTER CODES ARE GENERATED BY STANDARD TERMINAL, BUT ASSOCIATED CHARACTERS ARE NOT DISPLAYED ON THE THE SCREEN. REFER TO SECTION VII FOR DISPLAYABLE CHARACTER SET.

2. SINGLE CHARACTER ESCAPE SEQUENCES AND CONTROL CODES NOT LISTED WITH A FUNCTION ARE NEITHER ACTED UPON NOR DISPLAYED.

3. ESC H HOMES CURSOR INCLUDING TRANSMIT-ONLY FIELDS. ESC h HOMES CURSOR EXCLUDING TRANSMIT-ONLY FIELDS.

Table B-3. APL Symbols

SYMBOL NAMES				FORMING OVERSTRIKE SYMBOLS								
SYMBOL	NAME	SYMBOL	NAME	OVERSTRIKE CHARACTER	FORMED BY		OVERSTRIKE CHARACTER	FORMED BY		OVERSTRIKE CHARACTER	FORMED BY	
					OVERSTRIKING	WITH		OVERSTRIKING	WITH		OVERSTRIKING	WITH
¨	dieresis	α	alpha	¯	-	τ	⊕	0	~	⊞	Δ	□
¯	overbar	┘	upstile	{	<		⊞	0	□	⊞	•	□
<	less	┘	downstile	⊞	<	□	}]	•	τ	•	τ
≤	not greater	¯	underbar	⊞	<	>	}]	-	†	•	
=	equal	∇	del	⊞	<	>	}]	-	†	•	
≥	not less	Δ	delta	⊞	≤	□	∥]	[⊞	•	□
>	greater	•	null	⊞	=	γ	ƒ	[•	⊞	•	□
≠	not equal	•	quote	⊞	=	□	ƒ	[-	⊞	†	□
∨	or	□	quad	⊞	=	□	ƒ	[-	⊞	†	□
∧	and	(open paren	⊞	≥	□	ƒ	-	L	⊞	→	□
¯	bar)	close paren	}	>		⊞	-	o	⊞	∧	□
÷	divide	[open bracket	⊞	>	□	⊞	-	□	⊞	↑	□
+	plus]	close bracket	⊞	>	□	⊞	-	□	⊞	↑	□
x	times	⊞	open shoe	⊞	≠	□	⊞	-	\	⊞	↓	□
?	query	⊞	close shoe	⊞	∨	∧	⊞	\	o	⊞	~	□
ω	omega	∩	cap	∨	∨	~	⊞	\	□	⊞	*	□
ε	epsilon	∪	cup	∨	∨	~	⊞	\	□	⊞	*	□
ρ	rho	⊥	base	⊞	∨	□	⊞	←	□	⊞	o	□
~	tilde	τ	top	∨	,	∪	I	⊥	τ	⊞		□
↑	up (arrow)		stile	∨	,	∪	I	⊥	τ	⊞		□
↓	down (arrow)	:	semicolon	∨	,	∪	I	⊥	τ	⊞		□
ι	iota	:	colon	∨	,	-	A	∩	•	⊞	⊞	
○	circle	,	comma	!	.	,	⊞	∇	~	⊞	o	
*	star	.	dot	⊞	/	o	∨	∇		⊞	x	o
→	right (arrow)	\	slope	⊞	/	□	⊞	∇	□	⊞	*	o
←	left (arrow)	/	slash	⊞	/	□	⊞	∇	□	⊞	*	o
	space		space	∕	/	-	∧	Δ		∧	∧	~

⊞ character is displayed where an invalid overstrike is attempted.

Reference Tables

Table B-4. APL-ASCII Bit-Pairing Transmission Codes

BIT 4321	CONTROL (CNTL) CHARACTERS		DISPLAYABLE CHARACTERS						
	0 0 0	0 0 1	0 1 0	0 1 1	1 0 0	1 0 1	1 1 0	1 1 1	
0000	NUL / N _U	DLE / D _L	SP	0	←	*	→	P	
0001	SOH / S _H	DC1 / D ₁	..	1	α	?	A	Q	
0010	STX / S _X	DC2 / D ₂	-	2	⊥	ρ	B	R	
0011	ETX / E _X	DC3 / D ₃	<	3	η	Γ	C	S	
0100	EOT / E _T	DC4 / D ₄	≤	4	l	~	D	T	
0101	ENO / E _O	NAK / N _K	=	5	ε	↓	E	U	
0110	ACK / A _K	SYN / S _Y	≥	6	-	v	F	V	
0111	BEL / B _E	ETB / E _B	>	7	∇	ω	G	W	
1000	BS / B _S	CAN / C _N	≠	8	Δ	▷	H	X	
1001	HT / H _T	EM / E _M	v	9	ι	↑	I	Y	
1010	LF / L _F	SUB / S _B)]	•	c	J	Z	
1011	VT / V _T	ESC / E _C	(['	←	K	{	
1100	FF / F _F	FS / F _S	,	;	□	◊	L	\$	
1101	CR / C _R	GS / G _S	+	-		{	M	}	
1110	SO / S _O	RS / R _S	.	:	T	×	N	÷	
1111	SI / S _I	US / U _S	/	\	o	^	o	DEL	

Table B-5. APL-ASCII Typewriter-Pairing Transmission Codes (see Note)

BIT 4321	CONTROL (CNTL) CHARACTERS		DISPLAYABLE CHARACTERS						
	0 0 0	0 0 1	0 1 0	0 1 1	1 0 0	1 0 1	1 1 0	1 1 1	
0000	NUL / N _U	DLE / D _L	SP	0	-	*	◊	P	
0001	SOH / S _H	DC1 / D ₁	..	1	α	?	A	Q	
0010	STX / S _X	DC2 / D ₂)	2	⊥	ρ	B	R	
0011	ETX / E _X	DC3 / D ₃	<	3	η	Γ	C	S	
0100	EOT / E _T	DC4 / D ₄	≤	4	l	~	D	T	
0101	ENO / E _O	NAK / N _K	=	5	ε	↓	E	U	
0110	ACK / A _K	SYN / S _Y	>	6	-	v	F	V	
0111	BEL / B _E	ETB / E _B]	7	∇	ω	G	W	
1000	BS / B _S	CAN / C _N	v	8	Δ	▷	H	X	
1001	HT / H _T	EM / E _M	^	9	ι	↑	I	Y	
1010	LF / L _F	SUB / S _B	≠	(•	c	J	Z	
1011	VT / V _T	ESC / E _C	+	['	←	K	{	
1100	FF / F _F	FS / F _S	,	;	□	←	L	→	
1101	CR / C _R	GS / G _S	+	x		→	M	}	
1110	SO / S _O	RS / R _S	.	:	T	≥	N	\$	
1111	SI / S _I	US / U _S	/	\	o	-	o	DEL	

NOTE: These codes apply only when transmitting data to a printer. (Strapping option P on Keyboard Interface PCA controls which code will be sent to the printer — strap P closed = Bit Pairing, strap P open = Typewriter Pairing.)

Table B-6. Options and Accessories (2641A)

PRODUCT NUMBER	DESCRIPTION
2641A	<p>DISPLAY STATION Block or character mode, 128 character APL set, 64 character APL overstrike set, 64 character set upper case Roman, 4096 bytes of RAM memory, optionally expandable to 12K bytes, editing features, 8 user-defined soft keys, 110-9600 baud, RS232C, 5 option slots, inverse video, half-bright, underline, blinking, supports one additional character set. <i>Note: No interface cable included.</i></p> <p>-001 128 Character Set – Roman. Adds lower case</p> <p>-007 Integrated Dual Cartridge Tape – Mini Data Station Adds two built-in cartridge tape transports and electronics to provide Mini Data Station capabilities (requires 2 option slots). Includes device support firmware.</p> <p>-013 5 Mini Cartridges</p> <p>-015 50 Hertz</p> <p>-030 Delete Standard Asynchronous Communications <i>Note: One of the 13260 data communications accessories must be ordered when option 030 is ordered.</i></p> <p>-201 64 Character Mathematic Symbol Set. Adds display of integral signs, Greek letters, etc.</p> <p>-202 64 Character Line Drawing Set Adds display of continuous horizontal and vertical line segments for forms, histograms, etc.</p> <p>-203 Large Character Set <i>Note: Only one 200 series option can be ordered with each 2641A.</i></p>
ACCESSORIES	<p>13234A TERMINAL MEMORY MODULE (+4K) Adds 4096 bytes of user RAM memory (requires 1 option slot).</p> <p>13236B INTEGRATED DUAL CARTRIDGE TAPE UPGRADE KIT Field upgrade for adding two built-in cartridge tape transports and electronics to provide Mini Data Station capabilities (requires 2 option slots). Includes installation. <i>Note: 13261A also required.</i></p> <p>13238A TERMINAL DUPLEX REGISTER Adds support for HP 9866A or HP 9871A Line Printer (requires 1 option slot). No interface cable included. <i>Note: 13261A also required on tapeless 2641A's.</i></p> <p>13245A PROM CHARACTER SET ACCESSORY Assists user in design of custom character sets (requires 1 option slot).</p> <p>13250A SERIAL PRINTER INTERFACE Adds interface for connecting RS232C serial printing devices (requires 1 option slot). No interface cable included. <i>Note: 13261A also required on tapeless 2641A's.</i></p> <p>13260A STANDARD ASYNCHRONOUS COMMUNICATIONS Upgrade which provides standard RS232C communications interface for the 2641A. <i>Note: This is identical to the capability deleted by 2641A-030.</i></p> <p>13260B EXTENDED ASYNCHRONOUS COMMUNICATIONS Provides either an RS232C or 20mA current loop communication interface for the 2641A. Has split speed and custom baud rates. <i>Note: 2641A-030 must be ordered to delete the Standard Asynchronous interface.</i></p> <p>13260C ASYNCHRONOUS MULTIPOINT COMMUNICATIONS Provides asynchronous (patterned after Bisync) multipoint communications interface for the 2641A allowing daisy chained line sharing. <i>Note: 2641A-030 must be ordered to delete the Standard Asynchronous interface.</i></p> <p>-001 Add Monitor Mode Capability</p> <p>13260D SYNCHRONOUS MULTIPOINT COMMUNICATIONS – BISYNC Provides synchronous (Binary Synchronous Multipoint Communications compatible, Bisync.; <i>Note: IBM communications compatible, not plug-to-plug compatible because of differences in text character sequences for controlling terminal features)</i> multipoint communications interface for the 2641A allowing daisy chained line sharing. <i>Note: 2641A-030 must be ordered to delete the Standard Asynchronous interface.</i></p> <p>-001 Add Monitor Mode Capability</p> <p>13261A DEVICE SUPPORT FIRMWARE Required by tapeless 2641A's to support printers, tape upgrade or other I/O devices.</p> <p>13246A HP 9866A Thermal Dot Matrix Printer Subsystem – Prints Upper Case Roman Only.</p> <p>13246B HP 9866B Thermal Dot Matrix Printer Subsystem – Prints Upper & Lower Case Roman Only.</p> <p>13349A HP 9871A Fullfont Printer Subsystem – Prints Upper and Lower Case Roman Only.</p> <p>9162-0061 MINI CARTRIDGE (purchased from Corporate Parts Center)</p>
CABLES	<p>13232C RS232C Cable. 2641A/female RS232C, 5 ft.</p> <p>13232F Current Loop Connector Kit. 2641A/four wire, 5 ft.</p> <p>13232N Modem Cable. 2641A/male RS232C, 15 ft.</p> <p>13232P Modem/Multipoint Cable. Male RS232C/2641A/male multipoint connector, 30 ft. total.</p> <p>13232Q Multipoint Cable. Male multipoint/2641A/female multipoint connector, 30 ft. total.</p> <p>13232R Multipoint Extension Cable. Male multipoint/female multipoint connector, 100 ft.</p> <p>13232T Power Protect Multipoint Cable. Male multipoint/2641A connector with relays/female multipoint connector, 30 ft. total.</p> <p>13232U Modem Bypass Cable. Female RS232C/female RS232C, 5 ft.</p>

Table B-7. 2641A Specifications

GENERAL

Screen Size: 127 mm (5 inches) × 254 mm (10 inches)
 Screen Capacity: 24 lines × 80 columns (1,920 character)
 Character Generation: 7 × 9 enhanced dot matrix; 9 × 15 dot character cell; non-interlaced raster scan
 Character Size: 2.46 mm (.097 inches) × 3.175 mm (.125 inches)

Character Set: 128 character APL; 64 character upper-case Roman; 64 character APL overstrike

Note: The 2641A supports only one additional character set.

Cursor: Blinking-Underline

Display Modes: White on Black; Black on White (Inverse Video), Blinking, half-bright, Underline.

Refresh Rate: 60 Hz (50 Hz optional)

Tube Phosphor: P4

Implosion Protection: Bonded implosion panel

Memory: MOS, ROM: 24K bytes (program); RAM; std. 4096 bytes; 12 kilobytes max. (16K including max. data comm. buffer)

Option slots: 5 available

Keyboard: Detachable, full APL/ASCII code bit pairing keyboard, user-defined soft keys, and 18 additional control and editing keys; ten-key numeric pad; cursor pad; multispeed auto-repeat, N-key roll-over; 1.22m. (4 foot cable).

Cartridge Tape (option): Two mechanisms

Read/Write Speed: 10 ips

Search/Rewind Speed: 60 ips

Recording: 800 bpi

Mini Cartridge: 110 kilobyte capacity (maximum per cartridge)

DATA COMMUNICATIONS

Data Rate: 110, 150, 300, 1200, 2400, 4800, 9600 baud, and external. Switch selectable. (110 selects two stop bits). Operating above 4800 baud in APL mode may require nulls or handshake protocol to insure data integrity.

Standard Asynchronous Communications Interface: EIA standard RS232C; fully compatible with Bell 103A modems; compatible with Bell 202C/D/S/T modems. Choice of main channel or reverse channel line turnaround for half duplex operation

Optional Communications Interfaces (see 13260A/B/C/D Communications data sheet for details):

- Current loop, split speed, custom baud rates
- Asynchronous Multipoint Communications
- Synchronous Multipoint Communications – Bisync

Transmission Modes: Full or half duplex, asynchronous

Operating Modes: On-Line; Off-Line; Character, Block

Parity: Switch selectable; Even, Odd, None

ENVIRONMENTAL CONDITIONS

Temperature, Free Space Ambient:

Non-Operating: -40 to +75°C (-40 to +167°F)

Operating: 0 to 55°C (+32 to +131°F)

Temperature, Free Space Ambient (Tape):

Non-Operating: -10 to 60°C (-15 to +140°F)

Operating: 5 to 40°C (+41 to +104°F)

Humidity: 5 to 95% (non-condensing)

Altitude:

Non-Operating: Sea level to 7620 metres (25,000 feet)

Operating: Sea level to 4572 metres (15,000 feet)

Vibration and Shock (Type tested to qualify for normal shipping and handling in original shipping carton):

Vibration: .37 mm (0.015") pp, 10 to 55 Hz, 3 axis

Shock: 30g, 11ms, 1/2 sine

PHYSICAL SPECIFICATIONS

Display Monitor Weight: 19.6kg (43 pounds)

Keyboard Weight: 3.2kg (7 pounds)

Display Monitor Dimensions: 444 mmW × 457 mmD

× 342 mmH (17.5"W × 18"D × 13.5"H)

(648 mmD (25.5"D) including keyboard)

Keyboard Dimensions: 444 mmW × 216 mmD × 90 mmH

(17.5"W × 8.5"D × 3.5"H)

POWER REQUIREMENTS

Input Voltage: 115 (+10% -23%) at 60 Hz (±0.2%)

230 (+10% -23%) at 50 Hz (±0.2%)

Power Consumption: 85 W to 140 W max.

PRODUCT SAFETY

Product meets:

UL Requirements for: EDP equipment, office appliances, teaching equipment

CSA Requirements for: EDP equipment

U.L. and CSA labels are applied to equipment shipped to the U.S. and Canada.

PRODUCT SUPPORT**HP SYSTEMS SUPPORT**

Refer to appropriate HP system data sheet for use and support of 2641A in systems. If this product is used in a customer-assembled system, the overall operational responsibility of the system rests with the customer.

HARDWARE SUPPLIED

2641A Display Station

DOCUMENTATION SUPPLIED

2641A Display Station User's Manual

2641A Reference Manual

ORDERING EXAMPLE

Here is an example for ordering a 2641A Terminal with upper and lower case Roman character sets, line drawing character set, cartridge tape capability and five extra cartridges to be operated over phone lines:

2641A	APL Display Station
-001	Adds Lower Case Roman Character Set
-007	Adds Cartridge Tape Capability
-013	Adds Five Mini Cartridges
-202	Adds Line Drawing Character Set
13232N	Adds 103/202 Modem Cable — 15 ft.

Table B-8. Programmers Reference Table (2645A)

KEY or SWITCH	ESCAPE or CONTROL CODE	FUNCTION	KEY or SWITCH	ESCAPE or CONTROL CODE	FUNCTION
CHARACTER SET GROUP			GREEN TEST	—	2645 Self-Test (tests cartridges)
Alphabetical, numerical and symbol keys		Similar to typewriter keyboard	DISPLAY FUNCTIONS key & indicator	ESC Y (On) ESC Z (Off)	Control functions disabled and displayed
TAB key	HT (I ^c)	Forward cursor to next tab position.	DISPLAY FUNCTIONS ^c	ESC y (On) ESC Z (Off)	Monitor Mode. Display all codes recorded from data comm lines.
TAB ^c or Back Space ^c	ESC i	Back tab	BLOCK MODE latching key	—	Block Mode: data displayed but not transmitted until requested; otherwise, terminal in Character Mode and data transmitted as typed.
ESC (escape) key	ESC (I ^c)	Leads off an ASCII escape sequence.	REMOTE latching key	—	Remote (on-line) operations; otherwise, off-line operation
CNTL (control) key	c	Used to generate ASCII control codes.	CAPS LOCK latching key	—	Upper-case alphabetical lock
BACK SPACE key	BS (H ^c)	Cursor left one space	MEMORY LOCK key & indicator	ESC l (On) ESC m (Off)	Memory overflow protect; display lock
RETURN key	CR (M ^c)	Return cursor to start of line; clears I/O operations, screen messages; abort Green key operations.	AUTO LF latching key	—	Line Feed with each terminal carriage return
^c Control key (CNTL) depressed at same time					
NUMERICAL AND DISPLAY CONTROL GROUP			ADDITIONAL FUNCTIONS		
↑ key	ESC A	Cursor Up	—	ENQ (E ^c)	Enquiry from the computer
↓ key	ESC B	Cursor Down	—	ACK (F ^c)	Acknowledge — response to ENQ
→ key	ESC C	Cursor Right	—	BEL (G ^c)	Bell
← key	ESC D	Cursor Left	—	ESC)	Define Alternate Character Set: (@, A, B, C)
↖ key	ESC h	Cursor Home	—	SO (N ^c)	Turn on Alternate Character Set
↖ c	ESC F	Cursor Home Down	—	SI (O ^c)	Turn off Alternate Character Set
→ ^c	ESC 5	Right Margin Set	—	DCI (Q ^c)	Block Transfer Trigger
← ^c	ESC 4	Left Margin Set	—	DC2 (R ^c)	Block Transfer Enable from Terminal
CLEAR DSPLY key	ESC J	Clear memory from cursor position	—	ESC d	Block Transfer Enable from Computer
CLEAR DSPLY ^c	ESC K	Clear line from cursor	—	RS (Λ ^c)	Record Separator
ROLL UP key	ESC S	Scroll the display up one line	—	US (_ ^c)	Unit Separator
ROLL DOWN key	ESC T	Scroll the display down one line	—	ESC & a	Cursor Addressing
NEXT PAGE key	ESC U	Display the next 24 lines of memory	—	ESC a	Cursor Sensing (absolute)
PREV PAGE key	ESC V	Display the previous 24 lines of memory	—	ESC '	Cursor Sensing (Relative)
NEXT PAGE ^c	ESC j (On) ESC k (Off)	Display User-Defined Soft Keys	—	ESC _	Write Non-Displaying Terminator
SET TAB key	ESC 1	Set tab at the current cursor column	—	ESC b	Keyboard Enable
CLEAR TAB key	ESC 2	Clear a tab at the current cursor column	—	ESC c	Keyboard Disable
CLEAR TAB ^c	ESC 3	Clear all tabs	—	ESC e	Fast Binary Read
Ten-Key Numeric Group	—	Adding machine format keyboard	—	ESC f	Modem Disconnect
EDIT GROUP			—	ESC 6	Alphabetic Only Field
INSERT LINE key	ESC L	Blank line inserted	—	ESC 7	Numeric Only Field
DELETE LINE key	ESC M	Line containing cursor deleted	—	ESC 8	Alphanumeric Field
Green INSERT LINE	ESC & p 9C	Turn-on tape Write-Backspace-Read Mode	—	ESC I	Tab
Green DELETE LINE	ESC & p 10C	Turn-off tape Write-Backspace-Read Mode	—	ESC G	Cursor Return
INSERT CHAR key	ESC Q (On) ESC R (Off)	Succeeding inputs inserted at cursor	—	ESC H	Home cursor (excluding transmit only fields)
DELETE CHAR key	ESC P	Character at cursor deleted	—	ESC Λ	Terminal Status
INSERT CHAR ^c	ESC N (On) ESC R (Off)	Line Wraparound Mode. Succeeding inputs inserted at cursor with wraparound to next line.	—	ESC ~	Extended Status Request
DELETE CHAR ^c	ESC O	Delete character with wraparound from next line	—	ESC @	Delay one second
COMMUNICATIONS GROUP			—	LF (J ^c)	Move Cursor Down One Line
DUPLEX SWITCH	—	Half/Full	—	ESC & b	HP Diagnostic ONLY
PARITY switch	—	Even/Odd/None	—	ESC & f	Define User-Defined Soft Keys
BAUD RATE switch	—	110, 150, 300, 1200, 2400, 4800, 9600, external	—	ESC & g	Simulate PA, PF Keys
CONTROL GROUP			—	ESC & k	Define Latching Keys
RESET TERMINAL key	ESC g	(First press) Free the keyboard and clears I/O operations	—	ESC & p	I/O Control Sequence
TEST key	ESC E	(Second press) Set the terminal to power-on state	—	ESC & s	Define Strap Settings
TEST ^c	ESC z	2645 Self-Test (no cartridges) Conditions tape	f ₁ key f ₂ key f ₃ key f ₄ key f ₅ key f ₆ key f ₇ key f ₈ key	ESC p ESC q ESC r ESC s ESC t ESC u ESC v ESC w	Or up to 80-character user-defined sequence for each key (Display, transmit, or both)
			USER DEFINED SOFT KEY GROUP		
			User-Defined Soft Keys		

Data subject to change

Table B-8. Programmers Reference Table (2645A) (Continued)

KEY or SWITCH	ESCAPE or CONTROL CODE	FUNCTION	KEY or SWITCH	ESCAPE OR CONTROL CODE	FUNCTION																																																																																
fc ₁	ESC & d	Turn on Display Enhancement: <table border="1"> <tr> <td>@</td><td>A</td><td>B</td><td>C</td><td>D</td><td>E</td><td>F</td><td>G</td><td>H</td><td>I</td><td>J</td><td>K</td><td>L</td><td>M</td><td>N</td><td>O</td> </tr> <tr> <td>Half-Bright</td> <td></td><td></td><td></td><td></td><td></td><td></td><td></td><td>x</td><td>x</td><td>x</td><td>x</td><td>x</td><td>x</td><td>x</td><td>x</td> </tr> <tr> <td>Under-line</td> <td></td><td></td><td></td><td>x</td><td>x</td><td>x</td><td>x</td><td></td><td></td><td></td><td></td><td>x</td><td>x</td><td>x</td><td>x</td> </tr> <tr> <td>Inverse Video</td> <td></td><td>x</td><td>x</td><td></td><td></td><td>x</td><td>x</td><td></td><td></td><td>x</td><td>x</td><td></td><td></td><td>x</td><td>x</td> </tr> <tr> <td>Blinking</td> <td>x</td><td>x</td><td></td><td></td><td>x</td><td>x</td><td></td><td></td><td>x</td><td>x</td><td></td><td></td><td>x</td><td>x</td><td></td> </tr> </table>	@	A	B	C	D	E	F	G	H	I	J	K	L	M	N	O	Half-Bright								x	x	x	x	x	x	x	x	Under-line				x	x	x	x					x	x	x	x	Inverse Video		x	x			x	x			x	x			x	x	Blinking	x	x			x	x			x	x			x	x		<p>REWIND L. TAPE GREEN f₅</p> <p>or</p> <p>R. TAPE f₆</p> <p>MARK FILE L. TAPE GREEN f₆</p> <p>or</p> <p>R. TAPE f₆</p> <p>SKIP LINE L. TAPE GREEN f₇ ± n or</p> <p>R. TAPE f₆</p> <p>FIND FILEN L. TAPE GREEN f₈ ± n or</p> <p>R. TAPE f₆</p> <p>space</p>	<p>ESC & p 10u0C</p> <p>or</p> <p>ESC & p 2u0C</p> <p>ESC & p 1u5C</p> <p>or</p> <p>ESC & p 2u5C</p> <p>ESC & p ±np1u1C</p> <p>or</p> <p>ESC & p ±np2u1C</p> <p>ESC & p (±)np1u2C</p> <p>or</p> <p>ESC & p (±)np2uC</p>	<p>Rewinds LEFT TAPE</p> <p>or RIGHT TAPE</p> <p>Write a FILE MARK on LEFT TAPE or RIGHT TAPE</p> <p>Positions selected cartridge ±n records</p> <p>Positions selected cartridge to (±)n files</p> <p>Display file, inches remaining for each tape.</p>
@	A	B	C	D	E	F	G	H	I	J	K	L	M	N	O																																																																						
Half-Bright								x	x	x	x	x	x	x	x																																																																						
Under-line				x	x	x	x					x	x	x	x																																																																						
Inverse Video		x	x			x	x			x	x			x	x																																																																						
Blinking	x	x			x	x			x	x			x	x																																																																							
DATA PATH GROUP																																																																																					
READ key	-	One file transferred from selected source device to display (LOCAL) or transmitted (REMOTE)																																																																																			
READ ^c	-	Read page without DC handshake																																																																																			
GREEN READ ^c	-	Read tape beyond end-of-data mark																																																																																			
RECORD key	-	One file from the display (LOCAL) or data received (REMOTE) transferred to selected printer, display and/or tape																																																																																			
ENTER key	-	Same as RECORD (LOCAL) or enables block transfer (REMOTE)																																																																																			
GREEN ENTER	ESC x	Data Comm Self-Test																																																																																			
TRANSMIT indicator	-	Data Link Exists																																																																																			
BREAK key	-	Transmit BREAK signal to interrupt computer																																																																																			
GOLD f ₁	ESC & p1S	Assign LEFT TAPE as source																																																																																			
L TAPE																																																																																					
GOLD f ₂	ESC & p2S	Assign RIGHT TAPE as source																																																																																			
R. TAPE																																																																																					
GOLD f ₃	ESC & p3S	Assign DISPLAY as source																																																																																			
DISPLAY																																																																																					
GOLD f ₅	ESC & p1D	Assign LEFT TAPE as destination																																																																																			
L. TAPE																																																																																					
GOLD f ₆	ESC & p2D	Assign RIGHT TAPE as destination																																																																																			
R. TAPE																																																																																					
GOLD f ₇	ESC & p3D	Assign DISPLAY as destination																																																																																			
DISPLAY																																																																																					
GOLD f ₈	ESC & p4D	Assign PRINTER as destination																																																																																			
PRINTER																																																																																					
<p>NOTE: One source and multiple destinations can be set up with the same sequence.</p> <p>Example: GOLD f₁ f₇ f₈</p> <p>L. TAPE DISPLAY PRINTER</p> <p>ESC & p 1s3d 4D</p>																																																																																					
GREEN f ₁	ESC & pM	All data (current source position) from source transferred to destination																																																																																			
COPY ALL																																																																																					
GREEN f ₂	ESC & pF	One file (current source position) from source transferred to destination																																																																																			
COPY FILE																																																																																					
GREEN f ₃	ESC & pB	One line (current source position) from source transferred to destination																																																																																			
COPY LINE																																																																																					
GREEN f ₁ ^c	ESC & p1M	Compare data between source and destination																																																																																			
or																																																																																					
f ₂ ^c	ESC & p1F																																																																																				
or																																																																																					
f ₃ ^c	ESC & p1B																																																																																				
EDIT																																																																																					
GREEN f ₄	-	Toggle EDIT mode to provide automatic data logging. Lines of data transferred to destination(s) or as deleted from top of memory.																																																																																			

MAINFRAME REAR PANEL SWITCHES

PWR ON/OFF switch	-	Primary power to terminal
-------------------	---	---------------------------

Alternative Strappable Functions:

- Function key transmission
- Space overwrite (SPOW) latch enable
- Cursor end-of-line wraparound
- Block mode, page
- Paper tape mode
- Fast Binary read
- Block transfer handshake
- Eliminate block handshake
- ENTER inserts terminator automatically
- Reverse effect of CNTL on Insert/Delete Char.
- Send display codes to printer
- Self test inhibit
- Delete terminator after transmission

Status Information: memory size, strap settings, latching keys, transfer pending flags, error condition flags, device status, terminal type, data comm. status.

Tape, printer, display enhancement, monitor mode are optional capabilities.

Table B-9. Character Code Chart (2645A)

BIT 7 6 5 4321	CONTROL (CNTL) CHARACTERS				DISPLAYABLE CHARACTERS				ESCAPE PRESSED FIRST					
	0 0 0	0 0 1	0 1 0	0 1 1	1 0 0	1 0 1	1 1 0	1 1 1	0 1 0	0 1 1	1 0 0	1 0 1	1 1 0	1 1 1
0000	NUL	DL	SP	0	@	P	‘	p	SP	0	@	P	‘	p
0001	SOH	DC1	!	1	A	Q	a	q	!	1	A	Q	a	q
0010	STX	DC2	“	2	B	R	b	r	“	2	B	R	b	r
0011	ETX	DC3	#	3	C	S	c	s	#	3	C	S	c	s
0100	EOT	DC4	\$	4	D	T	d	t	\$	4	D	T	d	t
0101	ENQ	NAK	%	5	E	U	e	u	%	5	E	U	e	u
0110	ACK	SYN	&	6	F	V	f	v	&	6	F	V	f	v
0111	BEL	ETB	’	7	G	W	g	w	’	7	G	W	g	w
1000	BS	CAN	{	8	H	X	h	x	{	8	H	X	h	x
1001	HT	EM	}	9	I	Y	i	y	}	9	I	Y	i	y
1010	LF	SUB	*	:	J	Z	j	z	*	:	J	Z	j	z
1011	VT	ESC	+	;	K	[k	{	+	;	K	[k	{
1100	FF	FS	,	<	L	\	l	;	,	<	L	\	l	;
1101	CR	GS	-	=	M]	m	}	-	=	M]	m	}
1110	SO	RS	.	>	N	^	n	~	.	>	N	^	n	~
1111	SI	US	/	?	O	_	o	DEL	/	?	O	_	o	DEL

Example: J is bits 1001010; Control J is LF line feed; Escape (‘) followed by J is CLEAR DISPLAY

LEGEND

- | | | |
|------------------------|---------------------------------|----------------------------|
| AK — ACKNOWLEDGE | EM -- END OF MEDIUM | NK -- NEGATIVE ACKNOWLEDGE |
| BELL | EQ -- ENQUIRY | RS -- RECORD SEPARATOR |
| BS -- BACKSPACE | ET -- END OF TRANSMISSION | SI -- SHIFT IN |
| CN -- CANCEL LINE | EC -- ESCAPE | SO -- SHIFT OUT |
| CR -- CARRIAGE RETURN | EB -- END OF TRANSMISSION BLOCK | SP -- SPACE |
| D1 -- DEVICE CONTROL 1 | EX -- END OF TEXT | SH -- START OF HEADING |
| D2 -- DEVICE CONTROL 2 | FF -- FORM FEED | SX -- START OF TEXT |
| D3 -- DEVICE CONTROL 3 | FS -- FILE SEPARATOR | SB -- SUBSTITUTE |
| D4 -- DEVICE CONTROL 4 | GS -- GROUP SEPARATOR | SY -- SYNCHRONOUS IDLE |
| DEL -- DELETE | HT -- HORIZONTAL TABULATION | US -- UNIT SEPARATOR |
| DL -- DATA LINK ESCAPE | LF -- LINE FEED | VT -- VERTICAL TABULATION |

NOTES: 1. LOWER CASE LETTER, LOWER CASE SYMBOL, AND CONTROL CHARACTER CODES ARE GENERATED BY STANDARD TERMINAL, BUT ASSOCIATED CHARACTERS ARE NOT DISPLAYED ON THE THE SCREEN. REFER TO SECTION VII FOR DISPLAYABLE CHARACTER SET.

2. SINGLE CHARACTER ESCAPE SEQUENCES AND CONTROL CODES NOT LISTED WITH A FUNCTION ARE NEITHER ACTED UPON NOR DISPLAYED.

3. ESC H HOMES CURSOR INCLUDING TRANSMIT-ONLY FIELDS. ESC h HOMES CURSOR EXCLUDING TRANSMIT-ONLY FIELDS.

Table B-10. Options and Accessories (2645A)

PRODUCT NUMBER	DESCRIPTION
2645A	DISPLAY STATION Block or character mode, 64 character set upper case Roman, 4096 bytes of RAM memory, optionally expandable to 12K bytes, inverse video, editing features, 8 user-defined soft keys, 110-9600 baud, RS232C, 7 option slots. <i>Note: No interface cable included.</i>
-001	128 Character Set — Roman Adds lower case and displayable control codes.
-007	Integrated Dual Cartridge Tape — Mini DataStation Adds two built-in cartridge tape transports and electronics to provide Mini DataStation capabilities (requires 2 option slots). Includes device support firmware.
-013	5 Mini Cartridges
-015	50 Hertz
-030	Delete Standard Asynchronous Communications <i>Note: One of the 13260 data communications accessories must be ordered when option 030 is ordered.</i>
13231A	DISPLAY ENHANCEMENTS Adds blinking, half-bright and underline; and provides for addition of three 128 character sets (requires 1 option slot).
-201	64 Character Mathematic Symbol Set Adds display of integral signs, Greek letters, etc.
-202	64 Character Line Drawing Set Adds display of continuous horizontal and vertical line segments for forms, histograms, etc.
-203	Large Character Set Adds display of character segments for combination into large characters.
13234A	TERMINAL MEMORY MODULE (+4K) Adds 4096 bytes of user RAM memory (requires 1 option slot).
13236B	INTEGRATED DUAL CARTRIDGE TAPE UPGRADE KIT Field upgrade for adding two built-in cartridge tape transports and electronics to provide Mini DataStation capabilities (requires 2 option slots). Includes installation. <i>Note: 13261A also required.</i>
13238A	TERMINAL DUPLEX REGISTER Adds support for HP 9866A or HP 9871A Line Printer (requires 1 option slot). No interface cable included. <i>Note: 13261A also required on tapeless 2645A's.</i>
13245A	PROM CHARACTER SET ACCESSORY Assists user in design of custom character sets (requires 1 option slot).
13250A	SERIAL PRINTER INTERFACE Adds interface for connecting RS232C serial printing devices (requires 1 option slot). No interface cable included. <i>Note: 13261A also required on tapeless 2645A's.</i>
13260A	STANDARD ASYNCHRONOUS COMMUNICATIONS Upgrade which provides standard RS232C communications interface for the 2645A. <i>Note: This is identical to the capability deleted by 2645A-030.</i>
13260B	EXTENDED ASYNCHRONOUS COMMUNICATIONS Provides either an RS232C or 20mA current loop communication interface for the 2645A. Has split speed and custom baud rates. <i>Note: 2645A-030 must be ordered to delete the Standard Asynchronous interface.</i>
13260C	ASYNCHRONOUS MULTIPOINT COMMUNICATIONS Provides asynchronous (patterned after Bisync) multipoint communications interface for the 2645A allowing daisy chained line sharing. <i>Note: 2645A-030 must be ordered to delete the Standard Asynchronous interface.</i>
-001	Add Monitor Mode Capability
13260D	SYNCHRONOUS MULTIPOINT COMMUNICATIONS — BISYNC Provides synchronous (Binary Synchronous Multipoint Communications compatible, Bisync.; <i>Note: IBM communications compatible, not plug-to-plug compatible because of differences in text character sequences for controlling terminal features</i>) multipoint communications interface for the 2645A allowing daisy chained line sharing. <i>Note: 2645A-030 must be ordered to delete the Standard Asynchronous interface.</i>
-001	Add Monitor Mode Capability
13261A	DEVICE SUPPORT FIRMWARE Required by tapeless 2645A's to support printers, tape upgrade or other I/O devices.
CABLES	
13232C	RS232C Cable. 2645A/female RS232C, 5 ft.
13232F	Current Loop Connector Kit. 2645A/four wire, 5 ft.
13232N	Modem Cable. 2645A/male RS232C, 15 ft.
13232P	Modem/Multipoint Cable. Male RS232C/2645A/male multipoint connector, 30 ft. total.
13232Q	Multipoint Cable. Male multipoint/2645A/female multipoint connector, 30 ft. total.
13232R	Multipoint Extension Cable. Male multipoint/female multipoint connector, 100 ft.
13232T	Power Protect Multipoint Cable. Male multipoint/2645A connector with relays/female multipoint connector, 30 ft. total.
13232U	Modem Bypass Cable. Female RS232C/female RS232C, 5 ft.
13246A, 13246B, 13349A	Printer subsystems for the HP9866A/B/9871A printers are available for the 2645A
9162-0061	MINI CARTRIDGE (purchased from Corporate Parts Center)

Table B-11. 2645A Specifications

GENERAL	ENVIRONMENTAL CONDITIONS
Screen Size: 127 mm (5 inches) X 254 mm (10 inches)	Temperature, Free Space Ambient: Non-Operating: -40 to +75°C (-40 to +167°F) Operating: 0 to 55°C (+32 to +131°F)
Screen Capacity: 24 lines X 80 columns (1,920 character)	Temperature, Free Space Ambient (Tape): Non-Operating: -10 to +60°C (-15 to +140°F) Operating: 5 to +40°C (+41 to +104°F)
Character Generation: 7 X 9 enhanced dot matrix; 9 X 15 dot character cell; non-interlaced raster scan	Humidity: 5 to 95% (non-condensing)
Character Size: 2.46 mm (.097 inches) X 3.175 mm (.125 inches)	Humidity (Tape): 20 to 80% (non-condensing)
Character Set: 64 upper-case Roman	Altitude:
Cursor: Blinking-Underline	Non-Operating: Sea level to 7620 metres (25,000 feet) Operating: Sea level to 4572 metres (15,000 feet)
Display Modes: White on Black; Black on White (Inverse Video)	Vibration and Shock (Type tested to qualify for normal shipping and handling):
Refresh Rate: 60 Hz (50 Hz optional)	Vibration: .37 mm (0.012") pp, 10 to 55 Hz, 3 axis
Tube Phosphor: P4	Shock: 30g, 11ms, 1/2 sine
Implosion Protection: Bonded implosion panel	PHYSICAL SPECIFICATIONS
Memory: MOS, ROM: 22K bytes (program); RAM; std. 4096 bytes; 12 kilobytes max. (16K including max. data comm. buffer)	Display Monitor Weight: 19.6kg (43 pounds)
Keyboard: Detachable, full ASCII code keyboard, user-defined soft keys, and 18 additional control and editing keys; ten-key numeric pad; cursor pad; multi-speed auto-repeat, N-key roll-over; 1.22m. (4 foot cable).	Keyboard Weight: 3.2kg (7 pounds)
Cartridge Tape (option): Two mechanisms	Display Monitor Dimensions: 444 mmW X 457 mmD X 342 mmH (17.5"W X 18"D X 13.5"H) (648 mmD (25.5"D) including keyboard)
Read/Write Speed: 10 ips	Keyboard Dimensions: 444 mmW X 216 mmD X 90 mmH (17.5"W X 8.5"D X 3.5"H)
Search/Rewind Speed: 60 ips	POWER REQUIREMENTS
Recording: 800 bpi	Input Voltage: 115 (+10% -23%) at 60 Hz (±0.2%) 230 (+10% -23%) at 50 Hz (±0.2%)
Mini Cartridge: 110 kilobyte capacity (maximum per cartridge)	Power Consumption: 85 W to 140 W max.
DATA COMMUNICATIONS	
Data Rate: 110, 150, 300, 1200, 2400, 4800, 9600 baud, and external-switch selectable (110 selects two stop bits)	
Standard Asynchronous Communications Interface: EIA standard RS232C; fully compatible with Bell 103A modems; compatible with Bell 202C/D/S/T modems. Choice of main channel or reverse channel line turnaround for half duplex operation.	
Optional Communications Interfaces (see 13260A/B/C/D Communications data sheet for details):	
<ul style="list-style-type: none"> ● Current loop, split speed, custom baud rates ● Asynchronous Multipoint Communications ● Synchronous Multipoint Communications – Bisync 	
Transmission Modes: Full or half duplex, asynchronous	
Operating Modes: On-Line; Off-line; Character, Block	
Parity: Switch selectable; Even, Odd, None	

Table B-12. Programmers Reference Table (2645S)

KEY or SWITCH	ESCAPE or CONTROL CODE	FUNCTION	KEY or SWITCH	ESCAPE or CONTROL CODE	FUNCTION
CHARACTER SET GROUP			GREEN TEST	—	2645 Self-Test (tests cartridges)
Alphabetical, numerical and symbol keys		Similar to typewriter keyboard	DISPLAY FUNCTIONS key & indicator	ESC Y (On) ESC Z (Off)	Control functions disabled and displayed
TAB key	HT (I ^c)	Forward cursor to next tab position.	DISPLAY FUNCTIONS ^c	ESC y (On) ESC Z (Off)	Monitor Mode. Display all codes recorded from data comm lines.
TAB ^c or Back Space ^c	ESC i	Back tab	BLOCK MODE latching key	—	Block Mode: data displayed but not transmitted until requested; otherwise, terminal in Character Mode and data transmitted as typed.
ESC (escape) key	ESC (A ^c)	Leads off an ASCII escape sequence.	REMOTE latching key	—	Remote (on-line) operations; otherwise, off-line operation
CNTL (control) key	ESC c	Used to generate ASCII control codes.	CAPS LOCK latching key	—	Upper-case alphabetical lock
BACK SPACE key	BS (H ^c)	Cursor left one space	MEMORY LOCK key & indicator	ESC l (On) ESC m (Off)	Memory overflow protect; display lock
RETURN key	CR (M ^c)	Return cursor to start of line; clears I/O operations, screen messages; abort Green key operations.	AUTO LF latching key	—	Line Feed with each terminal carriage return
^c Control key (CNTL) depressed at same time					
NUMERICAL AND DISPLAY CONTROL GROUP			ADDITIONAL FUNCTIONS		
↑ key	ESC A	Cursor Up	—	ENQ (E ^c)	Enquiry from the computer
↓ key	ESC B	Cursor Down	—	ACK (F ^c)	Acknowledge — response to ENQ
→ key	ESC C	Cursor Right	—	BEL (G ^c)	Bell
← key	ESC D	Cursor Left	—	ESC)	Define Alternate Character Set: (@, A, B, C)
↖ key	ESC h	Cursor Home	—	SO (N ^c)	Turn on Alternate Character Set
↖ ^c	ESC F	Cursor Home Down	—	SI (O ^c)	Turn off Alternate Character Set
→ ^c	ESC 5	Right Margin Set	—	DC1 (Q ^c)	Block Transfer Trigger
← ^c	ESC 4	Left Margin Set	—	DC2 (R ^c)	Block Transfer Enable from Terminal
CLEAR DSPLY key	ESC J	Clear memory from cursor position	—	ESC d	Block Transfer Enable from Computer
CLEAR DSPLY ^c	ESC K	Clear line from cursor	—	RS (A ^c)	Record Separator
ROLL UP key	ESC S	Scroll the display up one line	—	US (DEL ^c)	Unit Separator
ROLL DOWN key	ESC T	Scroll the display down one line	—	ESC & a	Cursor Addressing
NEXT PAGE key	ESC U	Display the next 24 lines of memory	—	ESC a	Cursor Sensing (absolute)
PREV PAGE key	ESC V	Display the previous 24 lines of memory	—	ESC '	Cursor Sensing (Relative)
NEXT PAGE ^c	ESC j (On) ESC k (Off)	Display User-Defined Soft Keys	—	ESC _	Write Non-Displaying Terminator
SET TAB key	ESC 1	Set tab at the current cursor column	—	ESC b	Keyboard Enable
CLEAR TAB key	ESC 2	Clear a tab at the current cursor column	—	ESC c	Keyboard Disable
CLEAR TAB ^c	ESC 3	Clear all tabs	—	ESC e	Fast Binary Read
Ten-Key Numeric Group	—	Adding machine format keyboard	—	ESC f	Modem Disconnect
EDIT GROUP			—	ESC 6	Alphabetic Only Field
INSERT LINE key	ESC L	Blank line inserted	—	ESC 7	Numeric Only Field
DELETE LINE key	ESC M	Line containing cursor deleted	—	ESC 8	Alphanumeric Field
Green INSERT LINE	ESC & p 9C	Turn-on tape Write-Backspace-Read Mode	—	ESC I	Tab
Green DELETE LINE	ESC & p 10C	Turn-off tape Write-Backspace-Read Mode	—	ESC G	Cursor Return
INSERT CHAR key and indicator	ESC Q (On) ESC R (Off)	Succeeding inputs inserted at cursor	—	ESC H	Home cursor (excluding transmit only fields)
DELETE CHAR key	ESC P	Character at cursor deleted	—	ESC ^	Terminal Status
INSERT CHAR ^c	ESC N (On) ESC R (Off)	Line Wraparound Mode. Succeeding inputs inserted at cursor with wraparound to next line.	—	ESC ~	Extended Status Request
DELETE CHAR ^c	ESC O	Delete character with wraparound from next line	—	ESC @	Delay one second
COMMUNICATIONS GROUP			—	LF (J ^c)	Move Cursor Down One Line
DUPLEX SWITCH	—	Half/Full	—	ESC & b	HP Diagnostic ONLY
PARITY switch	—	Even/Odd/None	—	ESC & f	Define User-Defined Soft Keys
BAUD RATE switch	—	110, 150, 300, 1200, 2400, 4800, 9600, external	—	ESC & g	Simulate PA, PF Keys
CONTROL GROUP			—	ESC & k	Define Latching Keys
RESET TERMINAL key	ESC g	(First press) Free the keyboard and clears I/O operations	—	ESC & p	I/O Control Sequence
TEST key	ESC E	(Second press) Set the terminal to power-on state	—	ESC & s	Define Strap Settings
TEST ^c	ESC z	2645 Self-Test (no cartridges) Conditions tape	—		
CONTROL GROUP			USER-DEFINED SOFT KEY GROUP		
RESET TERMINAL key	ESC g	(First press) Free the keyboard and clears I/O operations	f1 key	ESC p	User-Defined Soft Keys Or up to 80-character user-defined sequence for each key (Display, transmit, or both)
TEST key	ESC E	(Second press) Set the terminal to power-on state	f2 key	ESC q	
TEST ^c	ESC z	2645 Self-Test (no cartridges) Conditions tape	f3 key	ESC r	
			f4 key	ESC s	
			f5 key	ESC t	
			f6 key	ESC u	
			f7 key	ESC v	
			f8 key	ESC w	

Data subject to change

Table B-12. Programmers Reference Table (2645S) (Continued)

KEY or SWITCH	ESCAPE or CONTROL CODE	FUNCTION	KEY or SWITCH	ESCAPE OR CONTROL CODE	FUNCTION																																																																																					
f ₁ ^c	ESC & d	Turn on Display Enhancement: <table border="1" style="font-size: small;"> <tr><td></td><td>@</td><td>A</td><td>B</td><td>C</td><td>D</td><td>E</td><td>F</td><td>G</td><td>H</td><td>I</td><td>J</td><td>K</td><td>L</td><td>M</td><td>N</td><td>O</td></tr> <tr><td>Half-Bright</td><td></td><td></td><td></td><td></td><td></td><td></td><td></td><td></td><td>x</td><td>x</td><td>x</td><td>x</td><td>x</td><td>x</td><td>x</td><td>x</td></tr> <tr><td>Under-line</td><td></td><td></td><td></td><td>x</td><td>x</td><td>x</td><td>x</td><td></td><td></td><td></td><td></td><td>x</td><td>x</td><td>x</td><td>x</td><td></td></tr> <tr><td>Inverse Video</td><td></td><td>x</td><td>x</td><td></td><td></td><td>x</td><td>x</td><td></td><td></td><td>x</td><td>x</td><td></td><td></td><td>x</td><td>x</td><td></td></tr> <tr><td>Blinking</td><td>x</td><td>x</td><td>x</td><td>x</td><td>x</td><td>x</td><td>x</td><td>x</td><td>x</td><td>x</td><td>x</td><td>x</td><td>x</td><td>x</td><td>x</td><td>x</td></tr> </table>		@	A	B	C	D	E	F	G	H	I	J	K	L	M	N	O	Half-Bright									x	x	x	x	x	x	x	x	Under-line				x	x	x	x					x	x	x	x		Inverse Video		x	x			x	x			x	x			x	x		Blinking	x	x	x	x	x	x	x	x	x	x	x	x	x	x	x	x	GREEN f ₅ (L. TAPE) or GREEN f ₆ (R. TAPE)	ESC & p 10u0C or ESC & p 2u0C	Rewinds LEFT TAPE or RIGHT TAPE
	@	A	B	C	D	E	F	G	H	I	J	K	L	M	N	O																																																																										
Half-Bright									x	x	x	x	x	x	x	x																																																																										
Under-line				x	x	x	x					x	x	x	x																																																																											
Inverse Video		x	x			x	x			x	x			x	x																																																																											
Blinking	x	x	x	x	x	x	x	x	x	x	x	x	x	x	x	x																																																																										
f ₂ ^c f ₃ ^c f ₄ ^c	ESC \bar{A} ESC \bar{A} ESC W (On)	Start Unprotected Field End Unprotected or Transmit-Only Field Format Mode. Protected fields can not be modified.	GREEN f ₅ (L. TAPE) or GREEN f ₆ (R. TAPE)	ESC & p 1u5C or ESC & p 2u5C	Write a FILE MARK on LEFT TAPE or RIGHT TAPE																																																																																					
f ₅ ^c f ₆ ^c	ESC X (Off) ESC \bar{a}	Start Transmit - Only Field	GREEN f ₇ (L. TAPE) or GREEN f ₆ (R. TAPE)	ESC & p 1np1u1C or ESC & p 2u1C	Positions selected cartridge ±n records																																																																																					
DATA PATH GROUP																																																																																										
READ key	-	One file transferred from selected source device to display (LOCAL) or transmitted (REMOTE)	GREEN f ₅ (L. TAPE) or GREEN f ₆ (R. TAPE)	ESC & p (±)np1u2C or ESC & p (±)np2uC	Positions selected cartridge to (±)n files																																																																																					
READ ^c	-	Read page without DC handshake	GREEN f ₈ (L. TAPE) or GREEN f ₆ (R. TAPE)	ESC & p (±)np2uC	Display file, inches remaining for each tape.																																																																																					
GREEN READ ^c	-	Read tape beyond end-of-data mark	GREEN space																																																																																							
RECORD key	-	One file from the display (LOCAL) or data received (REMOTE) transferred to selected printer, display and/or tape																																																																																								
ENTER key	-	Same as RECORD (LOCAL) or enables block transfer (REMOTE)																																																																																								
GREEN ENTER	ESC x	Data Comm Self-Test																																																																																								
TRANSMIT indicator	-	Data Link Exists																																																																																								
BREAK key	-	Transmit BREAK signal to interrupt computer																																																																																								
GOLD f ₁	ESC & p1S	Assign LEFT TAPE as source																																																																																								
L TAPE																																																																																										
GOLD f ₂	ESC & p2S	Assign RIGHT TAPE as source																																																																																								
R TAPE																																																																																										
GOLD f ₃	ESC & p3S	Assign DISPLAY as source																																																																																								
DISPLAY																																																																																										
GOLD f ₅	ESC & p1D	Assign LEFT TAPE as destination																																																																																								
L TAPE																																																																																										
GOLD f ₆	ESC & p2D	Assign RIGHT TAPE as destination																																																																																								
R TAPE																																																																																										
GOLD f ₇	ESC & p3D	Assign DISPLAY as destination																																																																																								
DISPLAY																																																																																										
GOLD f ₈	ESC & p4D	Assign PRINTER as destination																																																																																								
PRINTER																																																																																										
MAINFRAME REAR PANEL SWITCHES																																																																																										
PWR ON/OFF switch					Primary power to terminal																																																																																					
<p>Alternative Strappable Functions:</p> <ul style="list-style-type: none"> • Function key transmission • Space overwrite (SPOW) latch enable • Cursor end-of-line wraparound • Block mode, page • Paper tape mode • Fast Binary read • Block transfer handshake • Eliminate block handshake • ENTER inserts terminator automatically • Reverse effect of CNTL on Insert/Delete Char. • Send display codes to printer • Self test inhibit • Delete terminator after transmission <p>Status Information: memory size, strap settings, latching keys, transfer pending flags, error condition flags, device status, terminal type, data comm. status.</p> <p>Tape, printer, display enhancement, monitor mode are optional capabilities.</p>																																																																																										
<p>NOTE: One source and multiple destinations can be set up with the same sequence. Example: GOLD f₁ f₇ f₈ L TAPE DISPLAY PRINTER ESC & p 1s3d 4D</p>																																																																																										
GREEN f ₁	ESC & pM	All data (current source position) from source transferred to destination																																																																																								
GREEN f ₂	ESC & pF	One file (current source position) from source transferred to destination																																																																																								
GREEN f ₃	ESC & pB	One line (current source position) from source transferred to destination																																																																																								
GREEN f ₁ ^c	ESC & p1M	Compare data between source and destination																																																																																								
or GREEN f ₂ ^c	ESC & p1F																																																																																									
or GREEN f ₃ ^c	ESC & p1B																																																																																									
EDIT GREEN f ₄	-	Toggle EDIT mode to provide automatic data logging. Lines of data transferred to destination(s) or as deleted from top of memory.																																																																																								

Table B-13. Character Code Chart (2645S)

BIT 4321	CONTROL (CNTL) CHARACTERS		DISPLAYABLE CHARACTERS				ESCAPE PRESSED FIRST						
	0 0 0 1	0 0 0 1	0 1 0 1	0 1 0 1	1 0 1 0	1 0 1 0	1 0 1 0	1 0 1 0	1 0 1 0	1 1 1 1	1 1 1 1	1 1 1 1	
0000	NUL NUL	DLE DLE	SP SP	@ @	P P	\ \	p p	SP SP	0 0	@ @	P P	\ \	f ₁ f ₁
0001	SOH SOH	DC1 DC1	! !	1 1	A A	Q Q	a a	! !	1 1	A A	Q Q	a a	f ₂ f ₂
0010	STX STX	DC2 DC2	" "	2 2	B B	R R	b b	" "	2 2	B B	R R	b b	f ₃ f ₃
0011	ETX ETX	DC3 DC3	# #	3 3	C C	S S	c c	# #	3 3	C C	S S	c c	f ₄ f ₄
0100	EOT EOT	DC4 DC4	\$ \$	4 4	D D	T T	d d	\$ \$	4 4	D D	T T	d d	f ₅ f ₅
0101	ENQ ENQ	NAK NAK	% %	5 5	E E	U U	e e	% %	5 5	E E	U U	e e	f ₆ f ₆
0110	ACK ACK	SYN SYN	& &	6 6	F F	V V	f f	& &	6 6	F F	V V	f f	f ₇ f ₇
0111	BEL BELL	ETB ETB	' '	7 7	G G	W W	g g	' '	7 7	G G	W W	g g	f ₈ f ₈
1000	BS BS	CAN CAN	((8 8	H H	X X	h h	((8 8	H H	X X	h h	x x
1001	HT HT	EM EM))	9 9	I I	Y Y	i i))	9 9	I I	Y Y	i i	y y
1010	LF LF	SUB SUB	* *	: :	J J	Z Z	j j	* *	: :	J J	Z Z	j j	z z
1011	VT VT	ESC ESC	+ +	; ;	K K	Ä Ä	k k	+ +	; ;	K K	Ä Ä	k k	ä ä
1100	FF FF	FS FS	, ,	< <	L L	Ö Ö	l l	, ,	< <	L L	Ö Ö	l l	ö ö
1101	CR CR	GS GS	- -	= =	M M	Ä Ä	m m	- -	= =	M M	Ä Ä	m m	ä ä
1110	SO SO	RS RS	. .	> >	N N	Λ Λ	n n	. .	> >	N N	Λ Λ	n n	~ ~
1111	SI SI	US US	/ /	? ?	O O	— —	o o	/ /	? ?	O O	— —	o o	DEL DEL

Example: J is bits 1001010; Control J is LF line feed; Escape (ESC) followed by J is CLEAR DISPLAY

LEGEND

- | | | |
|-----------------------|--------------------------------|---------------------------|
| AK — ACKNOWLEDGE | EM — END OF MEDIUM | NK — NEGATIVE ACKNOWLEDGE |
| BEL — BELL | EQ — ENQUIRY | RS — RECORD SEPARATOR |
| BS — BACKSPACE | ET — END OF TRANSMISSION | SI — SHIFT IN |
| CN — CANCEL LINE | EC — ESCAPE | SO — SHIFT OUT |
| CR — CARRIAGE RETURN | EB — END OF TRANSMISSION BLOCK | SP — SPACE |
| D1 — DEVICE CONTROL 1 | EX — END OF TEXT | SH — START OF HEADING |
| D2 — DEVICE CONTROL 2 | FF — FORM FEED | SX — START OF TEXT |
| D3 — DEVICE CONTROL 3 | FS — FILE SEPARATOR | SB — SUBSTITUTE |
| D4 — DEVICE CONTROL 4 | GS — GROUP SEPARATOR | SY — SYNCHRONOUS IDLE |
| DEL — DELETE | HT — HORIZONTAL TABULATION | US — UNIT SEPARATOR |
| DL — DATA LINK ESCAPE | LF — LINE FEED | VT — VERTICAL TABULATION |

- NOTES: 1. LOWER CASE LETTER, LOWER CASE SYMBOL, AND CONTROL CHARACTER CODES ARE GENERATED BY STANDARD TERMINAL, BUT ASSOCIATED CHARACTERS ARE NOT DISPLAYED ON THE THE SCREEN. REFER TO SECTION VII FOR DISPLAYABLE CHARACTER SET.
2. SINGLE CHARACTER ESCAPE SEQUENCES AND CONTROL CODES NOT LISTED WITH A FUNCTION ARE NEITHER ACTED UPON NOR DISPLAYED.
3. ESC h HOMES CURSOR INCLUDING TRANSMIT-ONLY FIELDS. ESC h HOMES CURSOR EXCLUDING TRANSMIT-ONLY FIELDS.

Table B-14. Options and Accessories (2645S)

PRODUCT NUMBER	DESCRIPTION
2645S	DISPLAY STATION Block or character mode, 64 character set upper case Swedish/Finnish, 4096 bytes of RAM memory, optionally expandable to 12K bytes, inverse video, editing features, 8 user-defined soft keys, 110-9600 baud, RS232C, 7 option slots. <i>Note: No interface cable included.</i>
-001	128 Character Set — Swedish/Finnish Adds lower case and displayable control codes.
-007	Integrated Dual Cartridge Tape — Mini DataStation Adds two built-in cartridge tape transports and electronics to provide Mini DataStation capabilities (requires 2 option slots). Includes device support firmware.
-013	5 Mini Cartridges
-015	50 Hertz
-030	Delete Standard Asynchronous Communications <i>Note: One of the 13260 data communications accessories must be ordered when option 030 is ordered.</i>
13231A	DISPLAY ENHANCEMENTS Adds blinking, half-bright and underline; and provides for addition of three 128 character sets (requires 1 option slot).
-201	64 Character Mathematic Symbol Set—Adds display of integral signs, Greek letters, etc.
-202	64 Character Line Drawing Set—Adds display of continuous horizontal and vertical line segments for forms, histograms, etc.
-203	Large Character Set—Adds display of character segments for combination into large characters.
ACCESSORIES	
13234A	TERMINAL MEMORY MODULE (+4K) Adds 4096 bytes of user RAM memory (requires 1 option slot).
13236B	INTEGRATED DUAL CARTRIDGE TAPE UPGRADE KIT Field upgrade for adding two built-in cartridge tape transports and electronics to provide Mini DataStation capabilities (requires 2 option slots). Includes installation. <i>Note: 13261A also required.</i>
13238A	TERMINAL DUPLEX REGISTER Adds support for HP 9866A or HP 9871A Line Printer (requires 1 option slot). No interface cable included. <i>Note: 13261A also required on tapeless 2645S's.</i>
13245A	PROM CHARACTER SET ACCESSORY Assists user in design of custom character sets (requires 1 option slot).
13250B	SERIAL PRINTER INTERFACE Adds interface for connecting RS232C serial printing devices (requires 1 option slot). No interface cable included. <i>Note: 13261A also required on tapeless 2645S's.</i>
13260A	STANDARD ASYNCHRONOUS COMMUNICATIONS Upgrade which provides standard RS232C communications interface for the 2645S. <i>Note: This is identical to the capability deleted by 2645S-030.</i>
13260B	EXTENDED ASYNCHRONOUS COMMUNICATIONS Provides either an RS232C or 20mA current loop communication interface for the 2645S. Has split speed and custom baud rates. <i>Note: 2645S-030 must be ordered to delete the Standard Asynchronous interface.</i>
13260C	ASYNCHRONOUS MULTIPOINT COMMUNICATIONS Provides asynchronous (patterned after Bisync) multipoint communications interface for the 2645S allowing daisy chained line sharing. <i>Note: 2645S-030 must be ordered to delete the Standard Asynchronous interface.</i>
-001	Add monitor Mode Capability
13260D	SYNCHRONOUS MULTIPOINT COMMUNICATIONS — BISYNC Provides synchronous (Binary Synchronous Multipoint Communications compatible, Bisync.; <i>Note: IBM communications compatible, not plug-to-plug compatible because of differences in text character sequences for controlling terminal features</i>) multipoint communications interface for the 2645S allowing daisy chained line sharing. <i>Note: 2645S-030 must be ordered to delete the Standard Asynchronous interface.</i>
-001	Add Monitor Mode Capability
13261A	DEVICE SUPPORT FIRMWARE Required by tapeless 2645S's to support printers, tape upgrade or other I/O devices.
13246A	HP 9866A Thermal Dot Matrix Printer Subsystem — Prints Upper Case Roman Only.
13246B	HP 9866B Thermal Dot Matrix Printer Subsystem — Prints Upper & Lower Case Roman Only.
13349A	HP 9871A Fullfont Printer Subsystem — Prints Upper and Lower Case Roman Only.
9162-0061	MINI CARTRIDGE (purchased from Corporate Parts Center)
CABLES	
13232C	RS232C Cable. 2645/female RS232C, 5 ft.
13232F	Current Loop Connector Kit. 2645/four wire, 5 ft.
13232N	Modem Cable. 2645/male RS232C, 15 ft.
13232P	Modem/Multipoint Cable. Male RS232C/2645/male multipoint connector, 30 ft. total.
13232Q	Multipoint Cable. Male multipoint/2645/female multipoint connector, 30 ft. total.
13232R	Multipoint Extension Cable. Male multipoint/female multipoint connector, 100 ft.
13232T	Power Protect Multipoint Cable. Male multipoint/2645 connector with relays/female multipoint connector, 30 ft. total.
13232U	Modem Bypass Cable. Female RS232C/female RS232C, 5 ft.

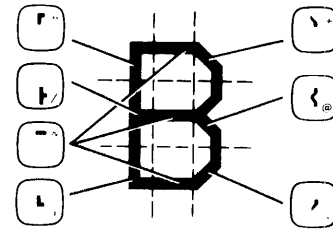
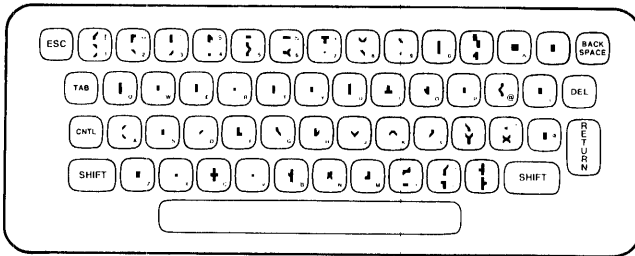
Table B-15. 2645S Specifications

<p>GENERAL</p> <p>Screen Size: 127 mm (5 inches) X 254 mm (10 inches)</p> <p>Screen Capacity: 24 lines X 80 columns (1,920 character)</p> <p>Character Generation: 7 X 9 enhanced dot matrix; 9 X 15 dot character cell; non-interlaced raster scan</p> <p>Character Size: 2.46 mm (.097 inches) X 3.175 mm (.125 inches)</p> <p>Character Set: 64 upper-case Swedish/Finnish</p> <p>Cursor: Blinking-Underline</p> <p>Display Modes: White on Black; Black on White Inverse Video)</p> <p>Refresh Rate: 60 Hz (50 Hz optional)</p> <p>Tube Phosphor: P4</p> <p>Implosion Protection: Bonded implosion panel</p> <p>Memory: MOS, ROM: 22K bytes (program); RAM; std. 4096 bytes; 12 kilobytes max. (16K including max. data comm. buffer)</p> <p>Keyboard: Detachable, full ISO code keyboard, user-defined soft keys, and 18 additional control and editing keys; ten-key numeric pad; cursor pad; multi-speed auto-repeat, N-key roll-over; 1.22m. (4 foot cable).</p> <p>Cartridge Tape (option): Two mechanisms</p> <p> Read/Write Speed: 10 ips</p> <p> Search/Rewind Speed: 60 ips</p> <p> Recording: 800 bpi</p> <p> Mini Cartridge: 110 kilobyte capacity (maximum per cartridge)</p> <p>DATA COMMUNICATIONS</p> <p>Data Rate: 110, 150, 300, 1200, 2400, 4800, 9600 baud, and external-switch selectable (110 selects two stop bits)</p> <p>Standard Asynchronous Communications Interface: EIA standard RS232C; fully compatible with Bell 103A modems; compatible with Bell 202C/D/S/T modems. Choice of main channel or reverse channel line turnaround for half duplex operation.</p> <p>Optional Communications Interfaces (see 13260A/B/C/D Communications data sheet for details):</p> <ul style="list-style-type: none"> ● Current loop, split speed, custom baud rates ● Asynchronous Multipoint Communications ● Synchronous Multipoint Communications – Bisync <p>Transmission Modes: Full or half duplex, asynchronous</p> <p>Operating Modes: On-Line; Off-line; Character, Block</p> <p>Parity: Switch selectable; Even, Odd, None</p> <p>ENVIRONMENTAL CONDITIONS</p> <p>Temperature, Free Space Ambient:</p> <p> Non-Operating: -40 to +75°C (-40 to +167°F)</p> <p> Operating: 0 to 55°C (+32 to +131°F)</p> <p>Temperature, Free Space Ambient (Tape):</p> <p> Non-Operating: -10 to +60°C (-15 to +140°F)</p> <p> Operating: 5 to +40°C (+41 to +104°F)</p> <p>Humidity: 5 to 95% (non-condensing)</p> <p>Humidity (Tape): 20 to 80% (non-condensing)</p> <p>Altitude:</p> <p> Non-Operating: Sea level to 7620 metres (25,000 feet)</p> <p> Operating: Sea level to 4572 metres (15,000 feet)</p>	<p>Vibration and Shock (Type tested to quality for normal shipping and handling):</p> <p> Vibration: .37 mm (0.012") pp, 10 to 55 Hz, 3 axis</p> <p> Shock: 30g, 11ms, 1/2 sine</p> <p>PHYSICAL SPECIFICATIONS</p> <p>Display Monitor Weight: 19.6kg (43 pounds)</p> <p>Keyboard Weight: 3.2kg (7 pounds)</p> <p>Display Monitor Dimensions: 444 mmW X 457 mmD X 342 mmH (17.5"W X 18"D X 13.5"H) (648 mmD (25.5"D) including keyboard)</p> <p>Keyboard Dimensions: 444 mmW X 216 mmD X 90 mmH (17.5"W X 8.5"D X 3.5"H)</p> <p>POWER REQUIREMENTS</p> <p>Input Voltage: 115 (+10% -23%) at 60 Hz (±0.2%) 230 (+10% -23%) at 50 Hz (±0.2%)</p> <p>Power Consumption: 85 W to 140 W max.</p> <p>PRODUCT SAFETY</p> <p>Product meets: UL Requirements for: EDP equipment office appliances teaching equipment</p> <p>CSA Requirements for: EDP equipment</p> <p>U.L. and CSA labels are applied to equipment shipped to the U.S. and Canada.</p> <p>PRODUCT SUPPORT</p> <p>WARRANTY</p> <p>90 day on-site parts and labor warranty</p> <p>HP SYSTEMS SUPPORT</p> <p>Refer to appropriate HP system data sheet for use and support of 2645S in systems. If this product is used in a customer-assembled system, the overall operational responsibility of the system rests with the customer.</p> <p>INSTALLATION</p> <p>All product preparation can be performed by the owner/user. Refer to reference manual supplied with unit for detailed instructions. HP assistance is provided for installation upon request and at prevailing rates.</p> <p>HARDWARE SUPPLIED</p> <p>2645S Display Station</p> <p>DOCUMENTATION SUPPLIED</p> <p>2645S Display Station User's Manual (02645-90024)</p> <p>2645S Reference Manual (02645-90005)</p> <p>ORDERING EXAMPLE</p> <p>Here is an example for ordering a 2645S Terminal with upper and lower case Swedish/Finnish character sets, line drawing character set, cartridge tape capability and five extra cartridges to be operated over phone lines:</p> <table style="width: 100%; border: none;"> <tr> <td style="width: 150px;">2645S</td> <td>Swedish/Finnish Display Station</td> </tr> <tr> <td>-001</td> <td>Adds Lower Case Swedish/Finnish Character Set</td> </tr> <tr> <td>-007</td> <td>Adds Cartridge Tape Capability</td> </tr> <tr> <td>-013</td> <td>Adds Five Mini Cartridges</td> </tr> <tr> <td>-202</td> <td>Adds Line Drawing Character Set</td> </tr> <tr> <td>13232N</td> <td>Adds 103/202 Modem Cable – 15 ft.</td> </tr> </table>	2645S	Swedish/Finnish Display Station	-001	Adds Lower Case Swedish/Finnish Character Set	-007	Adds Cartridge Tape Capability	-013	Adds Five Mini Cartridges	-202	Adds Line Drawing Character Set	13232N	Adds 103/202 Modem Cable – 15 ft.
2645S	Swedish/Finnish Display Station												
-001	Adds Lower Case Swedish/Finnish Character Set												
-007	Adds Cartridge Tape Capability												
-013	Adds Five Mini Cartridges												
-202	Adds Line Drawing Character Set												
13232N	Adds 103/202 Modem Cable – 15 ft.												

Table B-16. Coding the Large Character Set

The elements of the Large Character Set are associated with the keyboard as pictured below:

Each large character is actually made up of nine character segments. An example of constructing the letter "B" using the Large Character Set follows:



!	#	-	9	E	Q	J	i	U
0 S	0 S	%&, Z	!&+ G&? G&L	"&, /& F&, E	!&+ 0 0 G&N	%. 0 %M	* # E	" FM
"	"	.	:	F	R	^	j	U
0 S	0 S	Z	Z	"&, /& E	"&+ /&@ E E	9 K	* # GL	" GL
#	CC	÷	;	G	S	—	k	W
CC	CC	%&, 4	Y L	!&+ 0 G&L	!&+ G&+ G&L	...	/@ EE	" HD
\$!C+ GC+ GCL	0	<	H	T	`	l	X
0 S	0 S	!&+ 0 0 G&L	3 2	"&, /&? E E	%', 0 E	*	# 0 E	5@ EE
%	P P 3<D Y Y	1	=	I	U	a	m	4
0 S	0 S	- 0 E	%&, Z	' 0 I	# # 0 0 G&L	!. GM	\$- EE	" G?
&	!+ 5IC G&L	2	>	J	V	b	n	2
0 S	0 S	!&+ !&L F&, E) D	' 0 L	# # 0 0 2JD	/+ FL	" EE	%. F,
'	'	3	?	K	W	c	o	{
0 S	0 S	!&+ @ G&L	>D S	/6A E E	# # 090 HKD	!, G,	!+ GL	!, @ G,
(!, 0 G,	4	@	L	X	d	p	
0 S	0 S	# # F&C E	!&+ !.0 GIL	' 0 F&, E	# # 1:A E E	!? GM	" + /L	Q U
)	%+ 0 %L	5	A	M	Y	e	q	}
0 S	0 S	"&, F&+ G&L	!&+ /&? E E	\$(- 070 E E	# # 2;D E	!+ G,	!. G?	%+ 5 %L
x	1:A	6	B	N	Z	f	r	~
0 S	0 S	!&+ /&+ G&L	"&+ /&@ F&L	\$) 08B E E	"&. 3<D F&M	!+ C E	!, E	!&L
+	* %C, 4	7	C	O	[q	s	☒
0 S	0 S	%&. >D E	!&+ 0 G&L	"&. 0 0 F&M	" 0 F,	!. G?	!, %L	...
,	L	8	D	P	\	h	t	
0 S	0 S	!&+ 5@ G&L	"&+ 0 0 F&L	"&+ /&L E	' 2;) E	# /+ EE	* C GL	

COMMUNICATIONS FLOWCHARTS

APPENDIX

C

This appendix contains reference information on terminal communication functions. This material consists of the following flowcharts and tables:

- ASCII code table
- ASCII to EBCDIC code conversion table
- Overall point-to-point communications flowchart
- Keyboard communication switches

Table C-1 is a list of the ASCII characters and their decimal equivalents. Table C-2 contains information for converting data between the ASCII and EBCDIC character sets.

The flowchart in figure C-1 illustrates the overall point-to-point communication function. The various configuration parameters (switches) are included in the diagram. Detailed descriptions of the switches are given in Sections V and VII. Figure C-2 illustrates the way the terminal responds to various keyboard switches.

Table C-1. ASCII Character Set

DECIMAL VALUE	GRAPHIC	COMMENTS	ALTERNATE CHARACTER	DECIMAL VALUE	GRAPHIC	COMMENTS
0		Null	@ ^c	64	@	Commercial at
1		Start of heading	A ^c	65	A	Uppercase A
2		Start of text	B ^c	66	B	Uppercase B
3		End of text	C ^c	67	C	Uppercase C
4		End of transmission	D ^c	68	D	Uppercase D
5		Enquiry	E ^c	69	E	Uppercase E
6		Acknowledge	F ^c	70	F	Uppercase F
7		Bell	G ^c	71	G	Uppercase G
8		Backspace	H ^c	72	H	Uppercase H
9		Horizontal tabulation	I ^c	73	I	Uppercase I
10		Line feed	J ^c	74	J	Uppercase J
11		Vertical tabulation	K ^c	75	K	Uppercase K
12		Form feed	L ^c	76	L	Uppercase L
13		Carriage return	M ^c	77	M	Uppercase M
14		Shift out	N ^c	78	N	Uppercase N
15		Shift in	O ^c	79	O	Uppercase O
16		Data link escape	P ^c	80	P	Uppercase P
17		Device control 1 (X-ON)	Q ^c	81	Q	Uppercase Q
18		Device control 2	R ^c	82	R	Uppercase R
19		Device control 3 (X-OFF)	S ^c	83	S	Uppercase S
20		Device control 4	T ^c	84	T	Uppercase T
21		Negative acknowledge	U ^c	85	U	Uppercase U
22		Synchronous idle	V ^c	86	V	Uppercase V
23		End of transmission block	W ^c	87	W	Uppercase W
24		Cancel	X ^c	88	X	Uppercase X
25		End of medium	Y ^c	89	Y	Uppercase Y
26		Substitute	Z ^c	90	Z	Uppercase Z
27		Escape	[^c	¹ 91	[Opening bracket
28		File separator	\ ^c	² 92	\	Reverse slant
29		Group separator] ^c	¹ 93]	Closing bracket
30		Record separator	^ ^c	¹ 94	^	Circumflex
31		Unit separator	_ ^c	² 95	_	Underscore
32		Space (Blank)		96		Grave accent
¹ 33	!	Exclamation point		97	a	Lowercase a
34	"	Quotation mark		98	b	Lowercase b
35	#	Number sign		99	c	Lowercase c
36	\$	Dollar sign		100	d	Lowercase d
37	%	Percent sign		101	e	Lowercase e
38	&	Ampersand		102	f	Lowercase f
39	'	Apostrophe		103	g	Lowercase g
40	(Opening parenthesis		104	h	Lowercase h
41)	Closing parenthesis		105	i	Lowercase i
42	*	Asterisk		106	j	Lowercase j
43	+	Plus		107	k	Lowercase k
44	,	Comma		108	l	Lowercase l
45	-	Hyphen (Minus)		109	m	Lowercase m
46	.	Period (Decimal)		110	n	Lowercase n
47	/	Slant		111	o	Lowercase o
48	0	Zero		112	p	Lowercase p
49	1	One		113	q	Lowercase q
50	2	Two		114	r	Lowercase r
51	3	Three		115	s	Lowercase s
52	4	Four		116	t	Lowercase t
53	5	Five		117	u	Lowercase u
54	6	Six		118	v	Lowercase v
55	7	Seven		119	w	Lowercase w
56	8	Eight		120	x	Lowercase x
57	9	Nine		121	y	Lowercase y
58	:	Colon		122	z	Lowercase z
59	;	Semicolon		² 123	{	Opening (left) brace
60	<	Less than		² 124		Vertical line
61	=	Equals		² 125	}	Closing (right) brace
62	>	Greater than		² 126	~	Tilde
63	?	Question mark		127		Delete

Notes: 1. The equivalent EBCDIC character uses a different graphic.
2. No equivalent character exists in EBCDIC.

Table C-2. ASCII to EBCDIC Code Conversion Table

INPUT DIGIT			ASCII TO EBCDIC			EBCDIC TO ASCII			INPUT DIGIT			EBCDIC TO ASCII		
DEC	OCT	HEX	GPH	OCT	HEX	GPH	OCT	HEX	DEC	OCT	HEX	GPH	OCT	HEX
0	000	00	NUL	000	00	NUL	000	00	128	200	80			
1	001	01	SOH	001	01	SOH	001	01	129	201	81	a	141	61
2	002	02	STX	002	02	STX	002	02	130	202	82	b	142	62
3	003	03	ETX	003	03	ETX	003	03	131	203	83	c	143	63
4	004	04	EOT	067	37	PF			132	204	84	d	144	64
5	005	05	ENQ	055	2D	HT	011	09	133	205	85	e	145	65
6	006	06	ACK	056	2E				134	206	86	f	146	66
7	007	07	BEL	057	2F	DEL	177	7F	135	207	87	g	147	67
8	010	08	BS	026	16				136	210	88	h	150	68
9	011	09	HT	005	05				137	211	89	i	151	69
10	012	0A	LF	045	25				138	212	8A			
11	013	0B	VT	013	0B	VT	013	0B	139	213	8B			
12	014	0C	FF	014	0C	FF	014	0C	140	214	8C			
13	015	0D	CR	015	0D	CR	015	0D	141	215	8D			
14	016	0E	SO	016	0E	SO	016	0E	142	216	8E			
15	017	0F	SI	017	0F	SI	017	0F	143	217	8F			
16	020	10	DLE	020	10	DLE	020	10	144	220	90			
17	021	11	DC1	021	11	DC1	021	11	145	221	91	j	152	6A
18	022	12	DC2	022	12	DC2	022	12	146	222	92	k	153	6B
19	023	13	DC3	023	13	TM	023	13	147	223	93	l	154	6C
20	024	14	DC4	074	3C	RES			148	224	94	m	155	6D
21	025	15	NAK	075	3D	NL			149	225	95	n	156	6E
22	026	16	SYN	062	32	BS	010	08	150	226	96	o	157	6F
23	027	17	ETB	046	26	IL			151	227	97	p	160	70
24	030	18	CAN	030	18	CAN	030	18	152	230	98	q	161	71
25	031	19	EM	031	19	EM	031	19	153	231	99	r	162	72
26	032	1A	SUB	077	3F	CC			154	232	9A			
27	033	1B	ESC	047	27	CU1			155	233	9B			
28	034	1C	FS	034	1C	IFS	034	1C	156	234	9C			
29	035	1D	GS	035	1D	IGS	035	1D	157	235	9D			
30	036	1E	RS	036	1E	IRS	036	1E	158	236	9E			
31	037	1F	US	037	1F	IUS	037	1F	159	237	9F			
32	040	20	SP	100	40	DS			160	240	A0			
33	041	21	!	132	5A	SOS			161	241	A1	~	176	7E
34	042	22	"	177	7F	FS			162	242	A2	s	163	73
35	043	23	#	173	7B				163	243	A3	t	164	74
36	044	24	\$	133	5B	BYP			164	244	A4	u	165	75
37	045	25	%	154	6C	LF	012	0A	165	245	A5	v	166	76
38	046	26	&	120	50	ETB	027	17	166	246	A6	w	167	77
39	047	27	'	175	7D	LSC	033	21	167	247	A7	x	170	73
40	050	28	(115	4D				168	250	A8	y	171	79
41	051	29)	135	5D				169	251	A9	z	172	7A
42	052	2A	*	134	5C	SA			170	252	AA			
43	053	2B	+	116	4E	CU2			171	253	AB			
44	054	2C	,	153	6B				172	254	AC			
45	055	2D	-	140	60	ENQ	005	05	173	255	AD			
46	056	2E	.	113	4B	ACK	006	06	174	256	AE			
47	057	2F	/	141	61	BEL	007	07	175	257	AF			
48	060	30	0	360	F0				176	260	B0			
49	061	31	1	361	F1				177	261	B1			
50	062	32	2	362	F2	SYN	026	16	178	262	B2			
51	063	33	3	363	F3				179	263	B3			
52	064	34	4	364	F4	PN			180	264	B4			
53	065	35	5	365	F5	RS			181	265	B5			
54	066	36	6	366	F6	UC			182	266	B6			
55	067	37	7	367	F7	EOT	004	04	183	267	B7			
56	070	38	8	370	F8				184	270	B8			
57	071	39	9	371	F9				185	271	B9			
58	072	3A	:	172	7A				186	272	BA			
59	073	3B	;	136	5E	CU3			187	273	BB			
60	074	3C	<	114	4C	DC4	024	14	188	274	BC			
61	075	3D	=	176	7E	NAK	025	15	189	275	BD			
62	076	3E	>	156	6E				190	276	BE			
63	077	3F	?	157	6F	SUB	032	1A	191	277	BF			
64	100	40	@	174	7C	SP	040	20	192	300	C0	{	173	7B
65	101	41	A	301	C1				193	301	C1	A	101	41

Table C-2. ASCII/EBCDIC Code Conversion Table (Cont.)

INPUT DIGIT			ASCII TO EBCDIC			EBCDIC TO ASCII			INPUT DIGIT			EBCDIC TO ASCII		
DEC	OCT	HEX	GPH	OCT	HEX	GPH	OCT	HEX	DEC	OCT	HEX	GPH	OCT	HEX
66	102	42	B	302	C2				194	302	C2	B	102	42
67	103	43	C	303	C3				195	303	C3	C	103	43
68	104	44	D	304	C4				196	304	C4	D	104	44
69	105	45	E	305	C5				197	305	C5	E	105	45
70	106	46	F	306	C6				198	306	C6	F	106	46
71	107	47	G	307	C7				199	307	C7	G	107	47
72	110	48	H	310	C8				200	310	C8	H	110	48
73	111	49	I	311	C9				201	311	C9	I	111	49
74	112	4A	J	321	D1				202	312	CA			
75	113	4B	K	322	D2	.	056	2E	203	313	CB			
76	114	4C	L	323	D3	<	074	3C	204	314	CC			
77	115	4D	M	324	D4	(050	28	205	315	CD			
78	116	4E	N	325	D5	+	053	2B	206	316	CE			
79	117	4F	O	326	D6	^			207	317	CF			
80	120	50	P	327	D7	&	046	26	208	320	D0	}	175	7D
81	121	51	Q	330	D8				209	321	D1	J	112	4A
82	122	52	R	331	D9				210	322	D2	K	113	4B
83	123	53	S	342	E2				211	323	D3	L	114	4C
84	124	54	T	343	E3				212	324	D4	M	115	4D
85	125	55	U	344	E4				213	325	D5	N	116	4E
86	126	56	V	345	E5				214	326	D6	O	117	4F
87	127	57	W	346	E6				215	327	D7	P	120	50
88	130	58	X	347	E7				216	330	D8	Q	121	51
89	131	59	Y	350	E8				217	331	D9	R	122	52
90	132	5A	Z	351	E9	!	041	21	218	332	DA			
91	133	5B	[115	4D	\$	044	24	219	333	DB			
92	134	5C	\	340	EO	*	052	2A	220	334	DC			
93	135	5D]	135	5D)	051	29	221	335	DD			
94	136	5E	^	136	5E	;	073	3B	222	336	DE			
95	137	5F	_	155	6D				223	337	DF			
96	140	60	`	171	4F	-	055	2D	224	340	E0	\	134	5C
97	141	61	a	201	81	/	057	2F	225	341	E1			
98	142	62	b	202	82				226	342	E2	S	123	53
99	143	63	c	203	83				227	343	E3	T	124	54
100	144	64	d	204	84				228	344	E4	U	125	55
101	145	65	e	205	85				229	345	E5	V	126	56
102	146	66	f	206	86				230	346	E6	W	127	57
103	147	67	g	207	87				231	347	E7	X	130	58
104	150	68	h	210	88				232	350	E8	Y	131	59
105	151	69	i	211	89				233	351	E9	Z	132	5A
106	152	6A	j	221	91	!	174	7C	234	352	EA			
107	153	6B	k	222	92	,	054	2C	235	353	EB			
108	154	6C	l	223	93	%	045	25	236	354	EC			
109	155	6D	m	224	94		137	5F	237	355	ED			
110	156	6E	n	225	95	>	076	3E	238	356	EE			
111	157	6F	o	226	96	?	077	3F	239	357	EF			
112	160	70	p	227	97				240	360	F0	0	060	30
113	161	71	q	230	98				241	361	F1	1	061	31
114	162	72	r	231	99				242	362	F2	2	062	32
115	163	73	s	242	A2				243	363	F3	3	063	33
116	164	74	t	243	A3				244	364	F4	4	064	34
117	165	75	u	244	A4				245	365	F5	5	065	35
118	166	76	v	245	A5				246	366	F6	6	066	36
119	167	77	w	246	A6				247	367	F7	7	067	37
120	170	78	x	247	A7				248	370	F8	8	070	38
121	171	79	y	250	A8				249	371	F9	9	071	39
122	172	7A	z	251	A9	:	072	3A	250	372	FA			
123	173	7B	{	300	C0	#	043	23	251	373	FB			
124	174	7C		152	6A	@	100	40	252	374	FC			
125	175	7D	}	320	D0	'	047	27	253	375	FD			
126	176	7E	~	241	A1	=	075	3D	254	376	FE			
127	177	7F	DEL	007	07	"	042	22	255	377	FF			

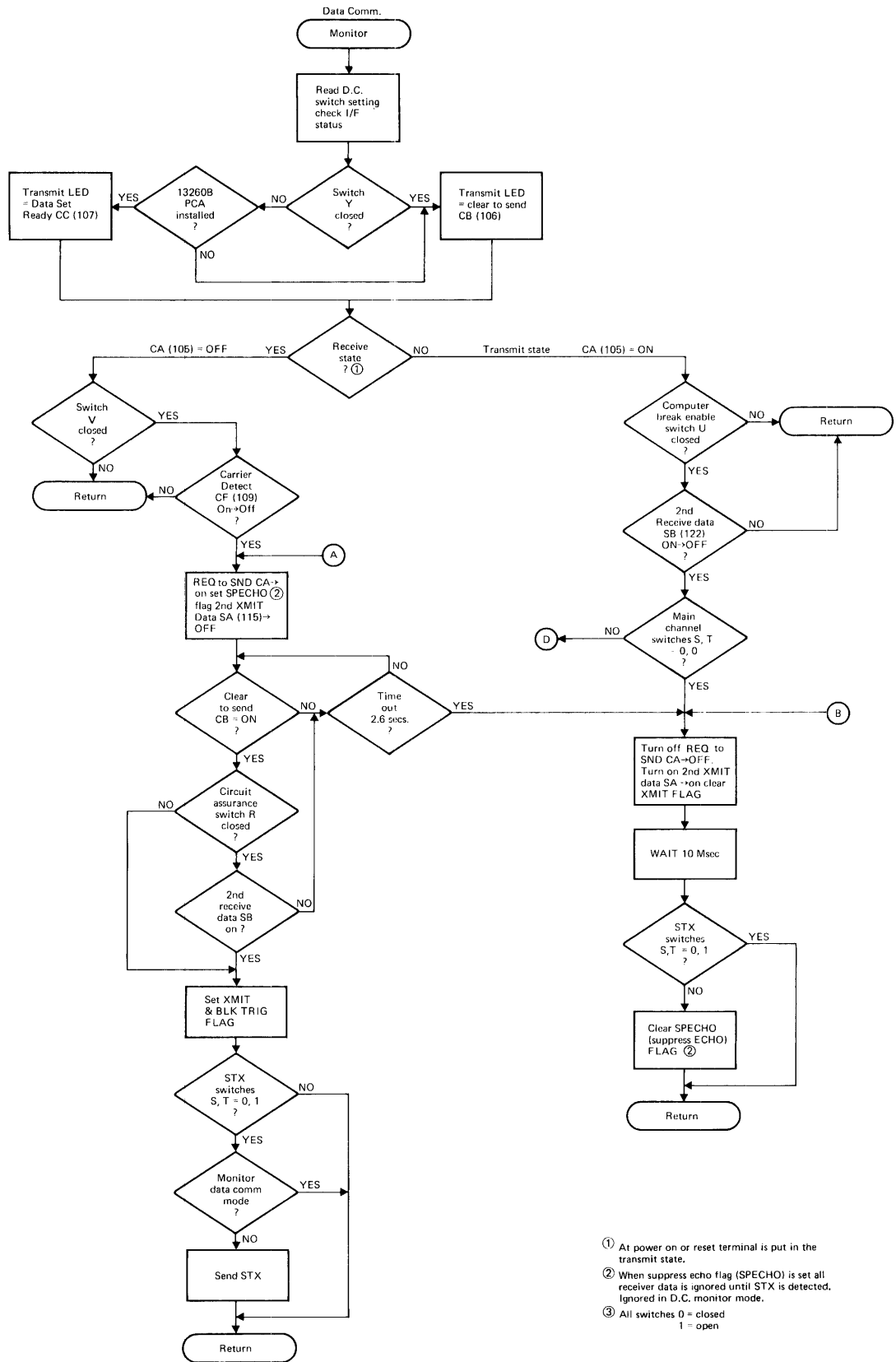


Figure C-1. Point-to-Point Communication Flowcharts (Sheet 1 of 3)

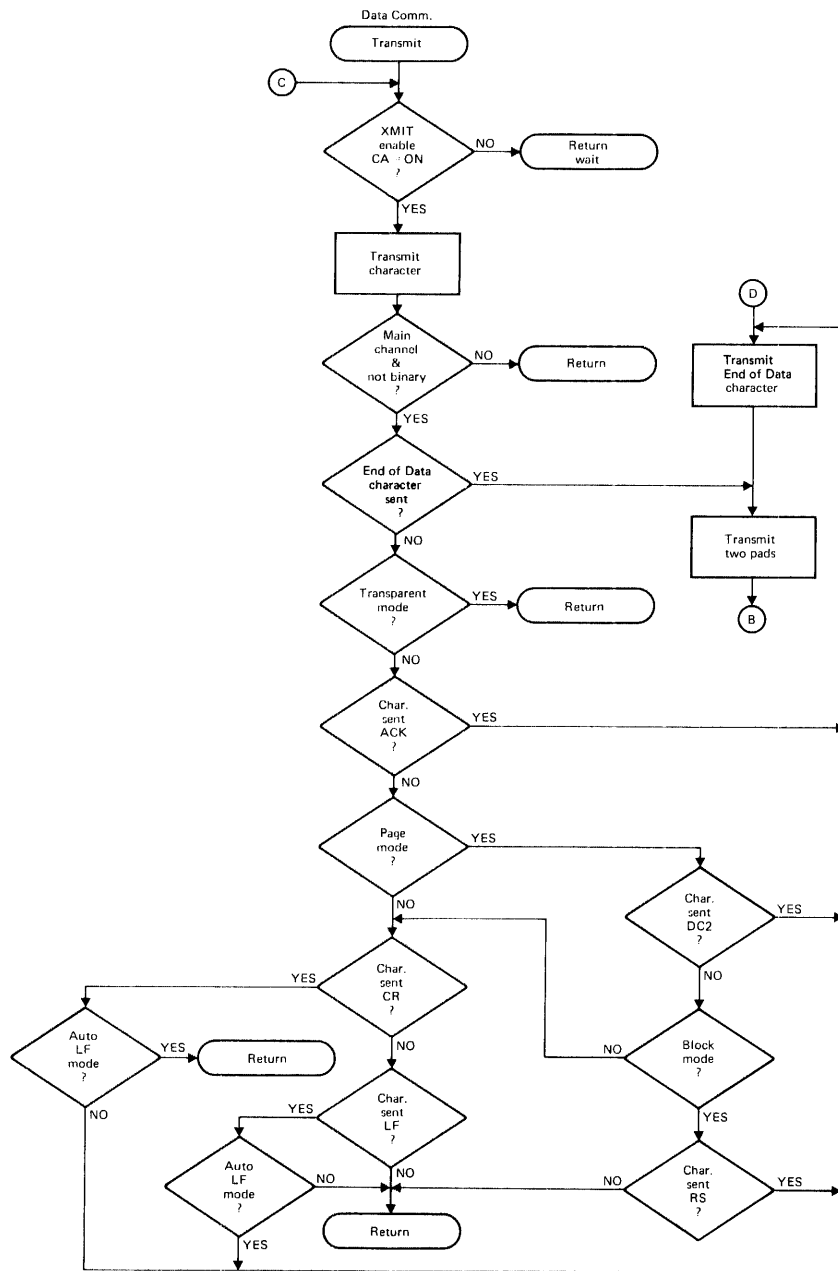


Figure C-1. Point-to-Point Communication Flowcharts (Sheet 2 of 3)

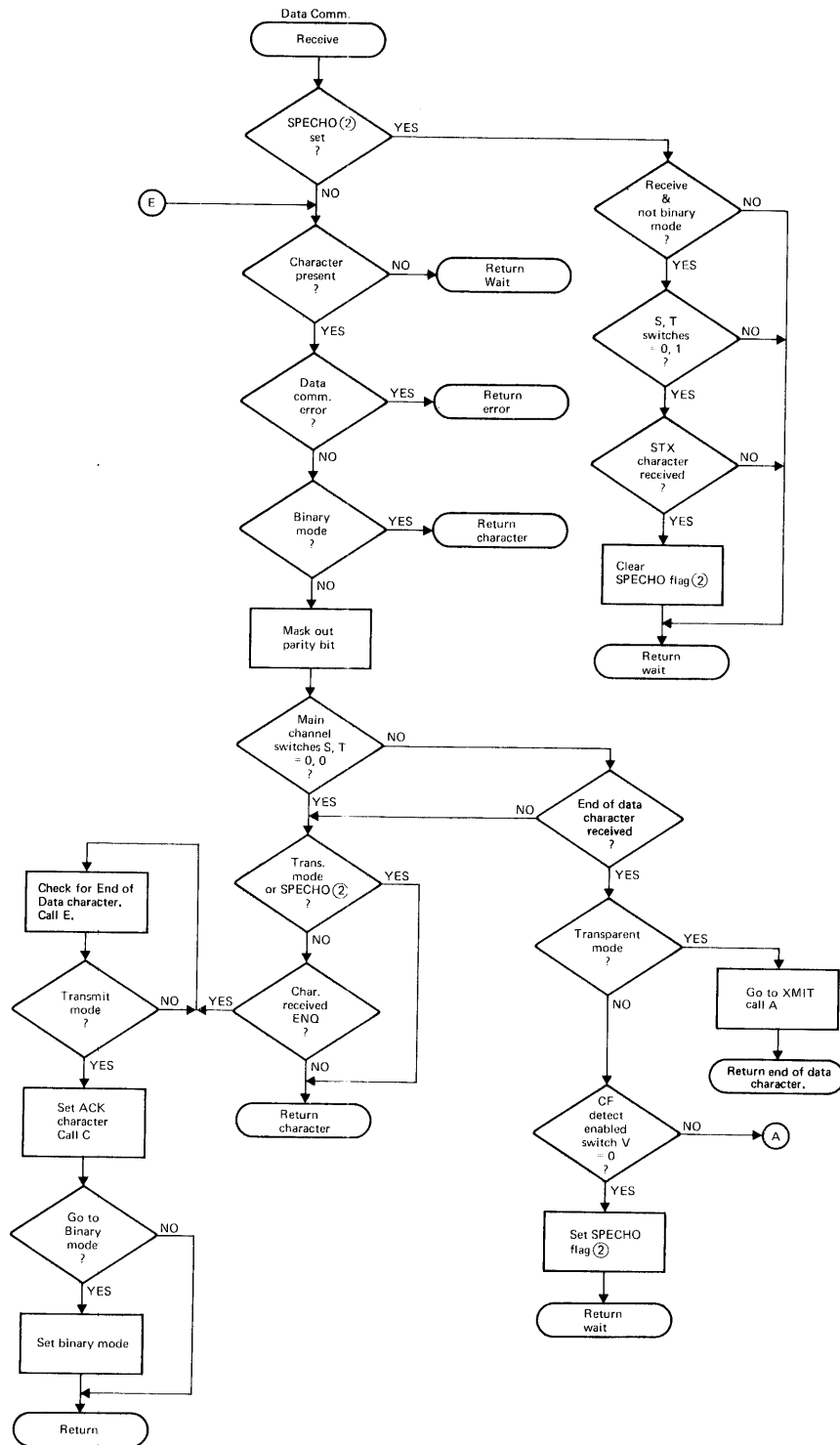


Figure C-1. Point-to-Point Communication Flowcharts (Sheet 3 of 3)

MULTIPLE CHARACTERS TRANSFER STRAP CONTROLS

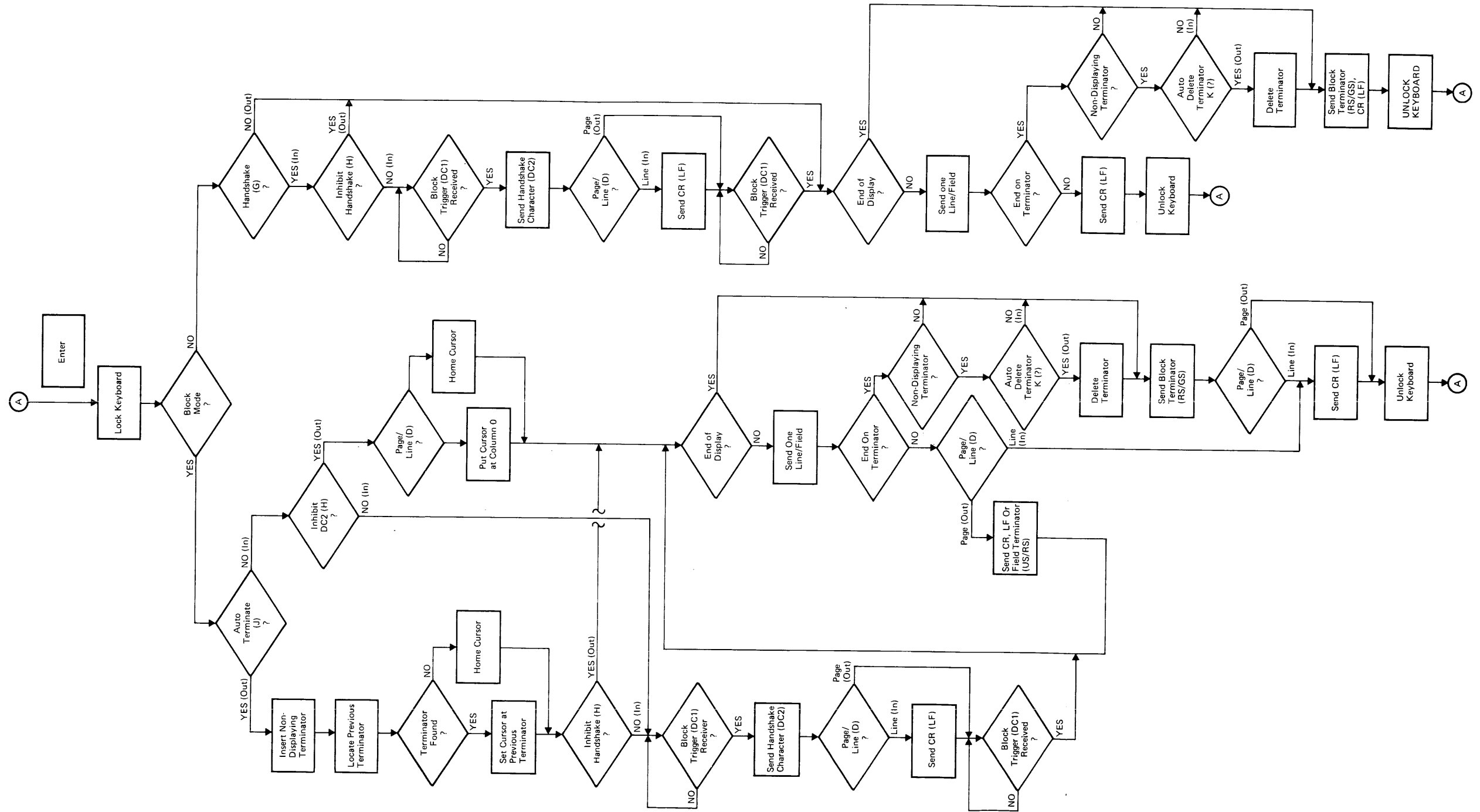


Figure C-2. Keyboard Communication Switches Flowcharts (Sheet 1 of 4)

MULTIPLE CHARACTERS TRANSFER STRAP CONTROLS

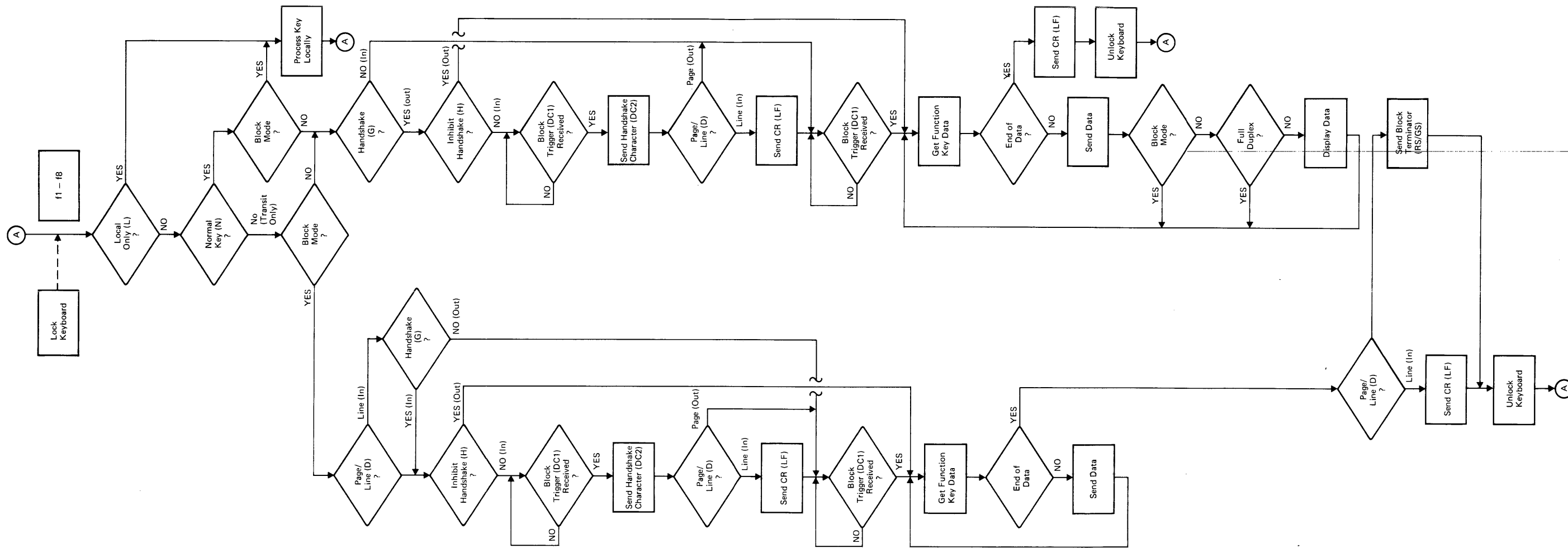


Figure C-2. Keyboard Communication Switches Flowcharts (Sheet 2 of 4)

MULTIPLE CHARACTERS TRANSFER STRAP CONTROLS

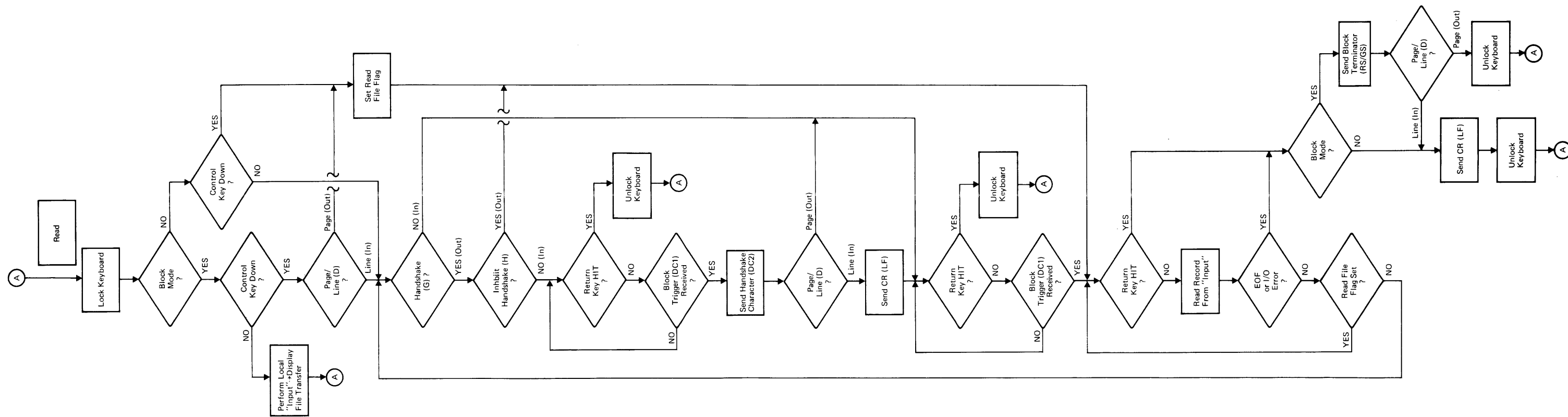


Figure C-2. Keyboard Communication Switches Flowcharts (Sheet 3 of 4)

MULTIPLE CHARACTERS TRANSFER STRAP CONTROLS

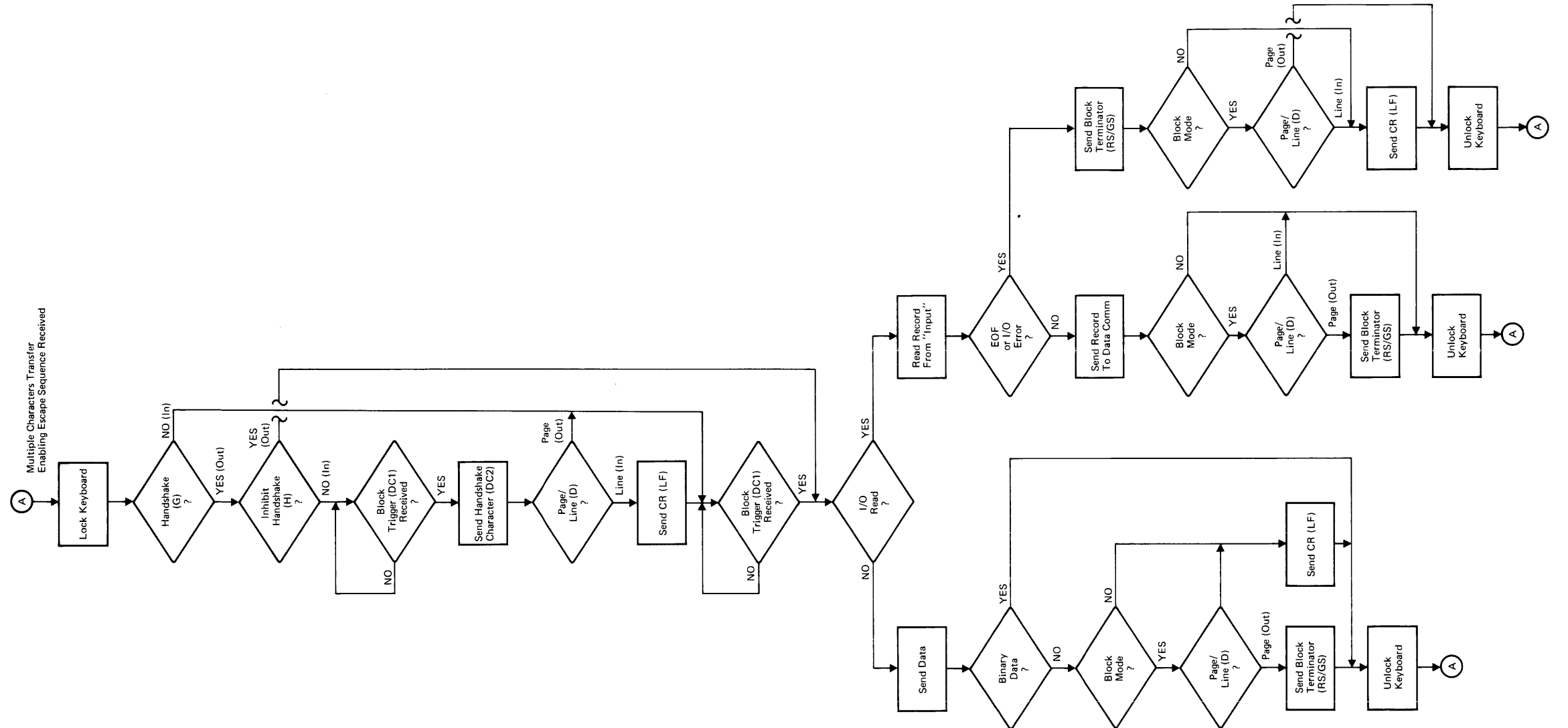


Figure C-2. Keyboard Communication Switches Flowcharts (Sheet 4 of 4)

TAPE CARTRIDGE RETHREADING

APPENDIX

D

Tape rethreading is difficult and is not recommended unless the data recorded on the runoff tape must be recovered. Instead, when tape runoff occurs, it is recommended to replace the entire tape cartridge. The rethreading procedures contained in this paragraph are for rethreading tape onto the tape cartridge's left tape hub. If a tape run-off condition occurs from the right tape hub, use the left tape hub rethreading instructions except interchange all right-hand and left-hand instructions and change all counter-clockwise directions to clockwise directions. This procedure requires the use of a small Phillips-head screwdriver. Rethread tape onto the left tape hub as follows:

CAUTION

Whenever the tape cartridge top cover is removed, the spring-loaded door and spring can easily slide off the door pivot post. To prevent loss of parts, ensure that door is always completely seated on its pivot post as long as the tape cartridge top cover and backplate are separated.

- Remove tape cartridge top cover by removing four screws from backplate with Phillips-head screwdriver.
- As shown in figure D-1, view A, rethread loose end of tape around right tape guide, through tape cleaner (use tweezers, if necessary), past belt drive puck, outside guide pin, and around left tape guide so that approximately 1-3/4 inches of tape is clear of guide.
- Hold tape cartridge as shown in figure D-1, view B, so that right hand can be used to rotate belt drive puck and left hand can be used to maintain tape tension at left tape guide.
- Moisten inside surface of free end of tape and, while maintaining tape tension at left tape guide, rotate belt drive puck counterclockwise to wrap free end of tape around left tape hub until tape reaches point where drive belt touches tape hub.
- While maintaining tape tension, use any small round-tipped tool to trap free end of tape between drive belt and left tape hub as shown in figure D-1, view C.
- Rotate belt drive puck counterclockwise until tape is wrapped several times around left tape hub past first set of tape holes (approximately two feet).

- Replace tape cartridge top cover on backplate and secure in place with four screws.
- Condition tape CNTL TAPE TEST, f₅ TO L TAPE or f₆ TO R TAPE.

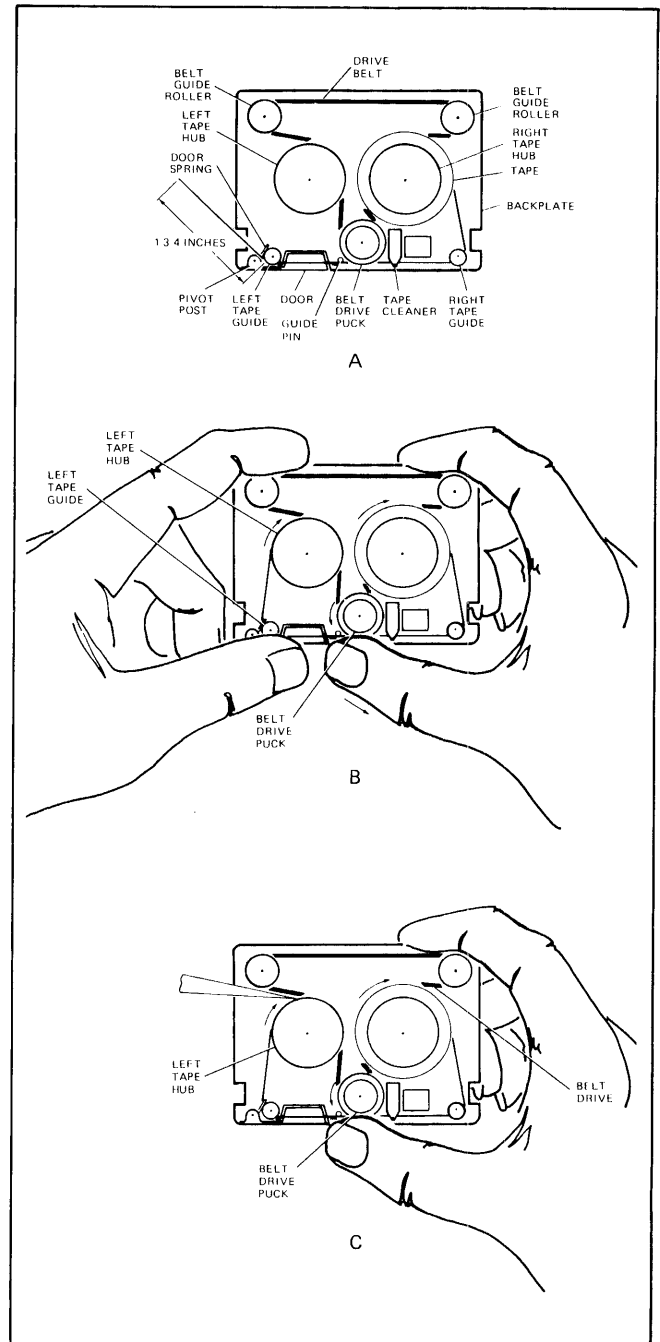


Figure D-1. Tape Cartridge Rethreading

- 13231 Display Enhancements 7-7
- 13232 Cable Assemblies 7-9
- 13234 4K Memory installation 7-10
- 13236 Tape installation 7-10
- 13238 Terminal Duplex Register installation 7-10
- 13245 Character Set Generation Kit installation .. 7-13
- 13246 Printer installation 7-13
- 13260 Interfaces, description 5-1
- 13260 Interfaces, installation 7-13
- 13260B Interface straps 7-27
- 13260C Interface straps 7-27
- 13260D Interface straps 7-27
- 13261 Device Support Firmware installation 7-15
- 13349 Printer installation 7-17
- 202 Modem compatibility 5-12
- 64 Character ROM installation 7-6
- 9866 Printer installation 7-13
- 9871 Printer installation 7-17

- accessory installation 7-6
- ACK 5-7
- ACK0 5-27
- ACK1 5-27
- addressing
 - absolute 2-2
 - column 2-2
 - combinations of absolute and relative 2-3
 - cursor relative 2-2
 - screen relative 2-2
- address, terminal 5-33
- AID character 5-38
- alpha field checking 2-7
- alternate character sets 2-9
- APL symbols B-5
- APL-ASCII bit pairing B-6
- APL-ASCII typewriter pairing B-6
- ASCII code selection 5-25
- Attention I.D. (AID) 5-38

- backspace 2-3, 4-2
- back tab 2-3
- basic communications 5-1
- baud rate selection 5-23
- Baud Rate switch (point-to-point) 5-4
- baud rate switches (block) 5-35
- BCC 5-27
- bell 3-5
- binary operation (block) 5-28
- binary read 4-5
- blinking 2-8
- block check character (BCC) 5-26
- block check mode 5-26
- block checking 5-25
- block configuration procedure 5-38
- block input mode (block) 5-27
- block mode 5-9
- Block Mode key 5-4
- block moves (text) 2-6
- block operation 5-24
- block protocols 5-7, 5-24
- Break key 5-4
- buffer overflow error 7-43
- buffer size 5-26
- byte count 4-1
- byte count, sending 4-3

- cable fabrication 7-34
- cable lengths 7-34
- cable types 7-26
- cables 7-8
- cartridge rethreading D-1
- CCA character 5-38
- CCITT signals 7-27
- character checking 5-25,
- character code chart B-4, B-11, B-16
- character delete 2-5
- Character Mode (block) 5-24
- Character Mode (point-to-point) 5-8
- character protocols 5-7
- character sets 2-8
- Character Set Generator installation 7-13
- character set selection 2-9
- clear display 2-4
- clear line 2-4
- clear tab 2-3
- code, device 4-1
- code selection 5-25
- coding the Large Character Set B-19
- communication protocols 5-6
- communication interface installation 7-14
- communication test procedure 7-43
- communications 5-1
- communications, basic 5-7
- communications flowchart C-1
- communications, point-to-point 5-7
- compare record 4-1
- completion, device 4-5
- computers, connecting to 5-1
- condition tape 4-2
- configuration (block) 5-38
- configuration (point-to-point) 5-15
- configuration status, block 5-37
- connecting terminals 5-1
- control bits, device 4-1
- control character protocol 5-15
- control functions, terminal 3-4
- control parameter, device 4-1

control sequences (block) 5-27, 5-35
control sequences, device 4-1
controlling the display 2-1
copy file 4-4
copy record 4-1, 4-4
copying to the end of a medium 4-5
CRC 5-25
Current Cursor Address (CCA) 5-38
cursor positioning 2-2
cursor sensing 2-2

data checking (communications) 5-25
data checking (fields) 2-7
data comm error 7-43
data communications 5-1
data overflow (block) 5-44
data transfers (block) 5-35
data transfers, device 4-3
default device 4-1
defining soft keys 3-3
delete character 2-5
delete line 2-5
device code 4-1
device completion 4-2
device control 4-1
Device I.D. 5-34
device functions 4-2
device selection 4-2
device status 6-6
Device Support firmware installation 7-15
display clear 2-3
display control 2-1
display enhancements 2-8, 2-15, 7-49
Display Enhancements, installation 7-7
display memory functions 2-1
display selection 4-2
distance, cabling limits 7-34
DLE 5-27
Driver Mode 5-45
Duplex Register installation 7-11
Duplex switch 5-4

EBCDIC code selection 5-27
edit functions 2-5
end-of-data, locating 4-2
ENQ (block) 5-29
ENQ (point-to-point) 5-7
Enter key 5-4
EOT 5-30
Error Messages (See *User's Manual*)
error tests 7-43
escape sequence, device 4-1
ETB 5-30
ETX 5-30
Extended Asynchronous Interface straps 7-23
Extended Text Features 5-37

fail 7-43
fast binary read 4-5
field checking 2-7
fields 2-7
file copy 4-4
file mark, recording 4-2
file transmission 4-3
find file 4-2
Format Mode 2-7
forms, building A-2
forms, creating 2-7
forms mode 2-7
forward space 4-2
from device selection 4-2
full duplex operation 5-9
full reset 3-5
function status, device 4-2
functions, device 4-2

grounding 7-5
Group I.D. 5-34
group polling 5-36
group select 5-39

half bright 2-8
half duplex operation 5-9
high-speed operation 5-7
home down 2-3
home up 2-3

I.D. Number 5-36
input buffer (communications) 5-27
insert character 2-5
insert line 2-5
installation 7-1
installation, accessory 7-6
interface cable signals 7-26
interface signals 5-1
interfaces 5-1
interfaces, data communications 5-1, 7-13
inverse video 2-8

keyboard disable 3-5
keyboard enable 3-5
Keyboard Interface switches (block) 5-32
Keyboard Interface switches (point-to-point) 5-13
Keyboard Interface switches, programming 3-6
keyboard overlay 7-15

Large Character Set 2-10, A-6
Large Character Set coding B-19
Large Character Set installation 7-7
latching keys, programming 3-1
line delete 2-5
line feed 2-3
Line Select 5-37
Line character set 2-10

Line Set installation	7-7	protected fields	2-7
locate end-of-data	4-2	protocol, block	5-24
logic levels	7-26	protocol, Main Channel	5-15
Lower Case ROM installation	7-6	protocol, Reverse Channel	5-15
LRC	5-25	protocols	5-7
Main Channel protocol	5-15	RAM error	7-39
margins	2-4	range switch	5-4
Math Character Set	2-10	read, binary	4-5
Math Set installation	7-7	read control byte	4-1
medium, copying to the end of a	4-5	record copy	4-4
memory configuration	7-10	recording file marks	4-2
memory lock	2-4	record transmission	4-3
message blocks	5-24	Remote key	5-4
modem disconnect command	3-5	reset terminal (full)	3-5
modems	5-6	reset terminal (soft)	3-5
Monitor Mode	5-15, 5-43	rethreading tapes	D-1
moving text blocks	2-6	retransmit last record	4-1
multicharacter transfers (block)	5-24	return	2-3
multicharacter transfers (point-to-point)	5-8	Reverse Channel protocol	5-15
multipoint	5-33	rewind	4-2
multipoint communications	5-1	roll down	2-4
multipoint example	A-1	roll up	2-4
NAK	5-29	ROM error	7-39
networks	5-1	RS232C signals	7-27
next page	2-4	RVI	5-28
no test	7-43		
numeric field checking	2-7	Scale switch	5-4
opening the terminal	7-2	secondary terminal status	6-4
options and accessories	B-7, B-12, B-17	selection, device	4-2
output buffer (communications)	5-27	selection, device function	4-2
PAD	5-30	selection (multipoint)	5-36
PA key	5-33	selection of character sets	2-9
page	2-4	Self-Test command	3-5
Parity Switch (block)	5-35	Self-Test procedure	7-39
Parity switch (point-to-point)	5-4	send byte count	4-1
PF key	5-33	send display	3-5
point-to-point	5-7	sensing the cursor position	2-2
point-to-point configuration	5-15	set tab	2-4
polling	5-35	signal levels	7-31
positioning the cursor	2-2	signal line control	5-12
Power Down Protect Cable	7-29	signals, interface	5-1, 7-26
power supply adjustment	7-17	soft key labels	3-4
primary terminal status	6-2	soft key programming	3-3
printer installation (9866)	7-13	soft reset	3-5
printer installation (9871)	7-17	specifications	B-8, B-13, B-18
printer selection	4-2	speed switches (block)	5-32
printer status	6-7	status	6-1
programmable keys	3-3	status, block configuration	5-37
Programmers Reference Table	B-2, B-9, B-14	status, device	6-6
programming Keyboard Interface switches	3-1	status interpretation	6-1
programming the latching keys	3-1	status, terminal	6-1
programming the soft keys	3-3	strap options (block)	5-25
program load command	3-5	strapping option selection	7-18
		STX	5-28
		switch settings	5-4, 5-32
		SYN	5-28
		synchronous compatibility (block)	5-37
		Synchronous Multipoint Interface	7-25

tab	2-4	terminal networks	5-1, 7-9
tape conditioning	4-2	terminal self-test command	3-5
tape installation	7-10	terminal status	6-1
tape rethreading	D-1	terminals, connecting	5-1
tape runoff	D-1	test patterns	7-39, 7-50, 7-51
tape selection	4-2	test tape	4-2
tape status	6-7	text moving	2-6
tape storage capacity	B-8, B-13, B-18	"to" device selection	4-2
tape test procedure	7-43	transferring data	4-3
tape test command	4-2	transmit byte count	4-3
teletype compatible operation	5-9	transmit file	4-1, 4-3
terminal address	5-33	transmit last record	4-1
terminal control functions	3-4	transmit indicator	5-4
terminal differences		transmit next record	4-1
additional control functions	3-6	transmit only fields	2-7
APL Printer Bit-Pairing Codes	3-6	transmit record	4-3
backspacing	2-14	transparency mode	5-26
block mode	2-15		
character mode	2-15	underline	2-8
defining soft keys	3-6	unprotected fields	2-6
display enhancements	2-15, 7-49		
Edit operations	2-14	voltage selection	7-5
ESCape key	2-14	VRC	5-25
forward spacing	2-14		
inputting data	2-15	WACK	5-28
keyboard interface switches	3-6	wait command	3-5
overstrikes	2-14	wraparound	2-5
self-test patterns	7-50, 7-51	WRU	5-37
soft key applications	3-6		
space overwrite latch functions	3-6		
underlining	2-14		
terminal I.D.	5-34		

